

GEO *line*®

by *Tecomec*

TECHNOLOGICAL PROGRESS IN AGRICULTURE



AGRICULTURAL
SPRAY
PRODUCTS

CATALOGUE **2019**

ITA-ENG-FRA
A00

1	Sistemi di controllo Control systems Systèmes de contrôle	Page 2
1A	Gruppi di comando Control units Groupes de commande	Page 58
2	Valvole a sfera Ball valves Vannes à bille	Page 130
3	Filtri di aspirazione e mandata Suction and line filters Filtres d'aspiration et filtres en ligne	Page 144
4	Raccorderia in polipropilene Polypropylene fittings Raccords en polypropylène	Page 178
5	Articoli per immissione liquidi e di completamento cisterne Basket filters, tank lids and accessories Articles pour l'équipement des cuves	Page 198
6	Ugelli e portaugelli Nozzles and nozzle holders Buses et porte-buses	Page 222
6A	Barre da diserbo Vineyard spray booms Rampes de pulvérisation	Page 282
7	Accessori irrorazione Sprayer accessories Accessoires de pulvérisation	Page 292

LEGENDA

Campo di impiego / Use / Utilisation



Per macchine a basso volume
For low-volume spraying machines
Pour machines basse volum



Per atomizzatori
For orchard sprayers
Pour atomiseurs



Per macchine da diserbo
For crop sprayers
Pour pulvérisateurs



Sistema di comando senza fili
Wireless control system
Système de commande sans câbles



Adatto per distributori olio idraulico
Suitable to hydraulic oil distributors
Approprié à groupe de distribution huile hydraulique



Assistenza telefonica 24h/24h
Phone Support 24h/24h
Assistance téléphonique 24h/24h

Caratteristiche / Features / Caractéristiques



Temperatura max
Max temperature
Temperature maxi



Tensione di alimentazione
Working voltage
Tension d'alimentation



Assorbimento elettrico
Power consumption
Absorption électrique



Accessori da ordinare separatamente *Accessories to be ordered separately* *Accessoires à commander séparément*

IN



Portagomma di entrata valvole generali
Inlet hoses for main valves
Porte-tuyau d'entrée pour vanne générale

OUT



Portagomma di uscita valvole di sezione
Outlet hoses for section valves
Porte-tuyau de sortie pour vanne de section

BY-PASS



Portagomma by-pass valvola generale
Hoses by-pass for main valves
Porte-tuyau by-pass pour vanne générale

ADAPTERS



Flange / Portagomma per valvole elettriche
Adapters / Hoses for electric valves
Bridges / Porte-tuyau pour vannes électriques

Accessori opzionali *Optionals* *Accessoires optionals*



Flussometro
Flowmeter
Débitmètre



Sensore di pressione
Pressure sensor
Capteur de pression



Sensore di livello
Level sensor
Capteur de niveau



Cavo collegamento
Connecting cable
Câble de branchement



Prolunga per cavo collegamento
Extension for connecting cable
Rallonge pour câble de branchement



Antenna GPS
GPS antenna
Antenne GPS



Supporto di fissaggio
Fixing support
Support de fixation

SISTEMI DI CONTROLLO 1

CONTROL SYSTEMS / SYSTÈMES DE CONTRÔLE

Sistemi di controllo

Questi dispositivi consentono la gestione ed il controllo dei parametri di trattamento alle colture. I sistemi di controllo Geoline sono di rapida installazione su ogni tipo di macchina operatrice del settore, garantiscono precisione ed efficienza nel lavoro e sono di facile utilizzo. La gamma è composta da: Computer GeoSystem, Visualizzatori GeoSystem, Scatole di comando elettriche, Radiocomandi, Accessori di completamento.

Control Units

These systems are our best solution for controlling and operating the working parameters. They are easy to fit and are adaptable to all working requirements of the machines on which they are installed. They allow the optimization of the treatment precisely and they are easy to use as well. The range of these systems is composed of the following parts: Geosystem Computer, Geosystem Display, Electric Driver Box, Radio remote controls, Optionals.

Systèmes de contrôle

Ces dispositifs permettent la gestion et le contrôle des paramètres de traitement pour les cultures. Les systèmes de contrôle Geoline ont une installation rapide sur tout type des machine-outil, garantissent précision et efficacité dans le travail et sont faciles à utiliser. La gamme se compose de: Ordinateur GeoSystem, Visualisateurs GeoSystem, Boîtes de commande électriques, Radioguidages, Accessoires optionnels.





GeoSystem 260

Computer per distribuzione di prodotti fitosanitari, adatto per macchine da diserbo, atomizzatori e multi-filari.

Caratteristiche:

- Versioni: fino a 7 valvole di sezione e 9 valvole idrauliche.
- Funzionamento automatico e manuale.
- Scatola di derivazione (Driver Box) a cablaggio semplificato di rapida installazione.
- Display grafico LCD retroilluminato di grandi dimensioni, leggibile in ogni condizione di luce.
- Possibilità di collegare il navigatore satellitare (opzionale) e di gestire in modo automatico la chiusura delle sezioni.
- Scambio dati e aggiornamento software tramite USB (standard)
- Scambio dati con FIELD Trace (opzionale).
- Compatibilità protocollo T.U.V.R. (Trimble®)
- Menu multilingua
- Inserimento semplificato dei parametri di lavoro
- Memorizzazione parametri di 8 ugelli personalizzati (in aggiunta agli ugelli ISO).
- Unità di misura configurabili: Metrico / US.
- Configurazione di 10 diversi tipi di trattamento.
- Allarmi visivi e sonori
- Strumento di diagnostica integrato
- Gestione tracciafile (solo per versione CS)
- Parametri gestiti: pressione, velocità, portata, area trattata, quantità distribuita, durata del trattamento, distanza percorsa, livello cisterna.

Computer for distributing phytosanitary products, suitable for weed-killing machines, sprayers and multi-row machines.

Features:

- Versions: up to 7 section valves and 9 hydraulic valves.
- Automatic and manual operation.
- Connecting box (Driver Box) with simplified, quick-to-install wiring.
- Large, rear-lit LCD graphic display, legible in all lighting conditions.
- Possibility to connect sat nav (optional) and automatically manage section closure.
- Data exchange and software updating by USB (standard)
- Data exchange with FIELD Trace software (optional).
- T.U.V.R. protocol compatibility (Trimble®)
- Multilingual menu
- Simplified work parameter entry
- 8 customised nozzle parameter storage (in addition to ISO nozzles).
- Configurable units of measurement: Metric/ US.
- Configuration of 10 different types of treatment.
- Visual and acoustic alarms
- Integrated diagnostic tool
- Foam marker management (only for CS version)
- Parameters managed: pressure, speed, flow rate, treated area, distributed quantity, treatment duration, distance travelled, tank level.

Ordinateur de distribution de produits phytosanitaires, adapté aux machines de désherbage, atomiseurs et multifilaires.

Caractéristiques :

- Versions : jusqu'à 7 vannes de section et 9 vannes hydrauliques.
- Fonctionnement automatique et manuel.
- Boîtier de dérivation (Driver Box) à câblage simplifié rapide à installer.
- Écran graphique LCD à rétro-éclairage de grandes dimensions, lisible dans toute condition de luminosité.
- Possibilité de connexion du navigateur satellitaire (option) et de gestion automatique de la fermeture des sections.
- Échange de données et mise à jour du logiciel via USB (standard).
- Échange de données avec FIELD Trace (option).
- Compatibilité protocole T.U.V.R. (Trimble®)
- Menu multilingue.
- Saisie simplifiée des paramètres de travail.
- Mémorisation des paramètres de 8 buses personnalisées (outre les buses ISO).
- Unités de mesure configurables : Métrique/ US.
- Configuration de 10 types de traitement différents.
- Alarmes visuelles et sonores.
- Instrument de diagnostic intégré.
- Gestion traceur de files (sur version CS uniquement)
- Paramètres gérés : pression, vitesse, débit, superficie traitée, quantité distribuée, durée du traitement, distance parcourue et niveau citerne.

GPS System



Pag. 6

260 CS



Pag. 8

260 CS H



Pag. 10

260 OS



Pag. 12

260 MRS



Pag. 14

GPS System

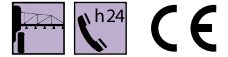

Progettato per la guida di base, GPS System offre il software Horizon in un formato semplice e facile da usare. Un touch screen 3D a colori offre guida con mappe mobili o sterzata automatica, oltre che una barra luminosa virtuale su schermo. Dotato di funzionalità complete per le sue dimensioni, GPS System offre un design modulare con menu di navigazione su schermo, una gamma di schemi di sterzata, oltre a mappatura della copertura e ritorno al punto di arresto.

Caratteristiche:

- Gamma completa di modalità di guida manuale e automatica;
- Interfaccia semplice, intuitiva, basata su icone e configurabile dall'utente;
- Facilità di installazione sui veicoli più diffusi sul mercato;
- Display luminoso leggibile al sole;
- Facilità di apprendimento, utilizzo e upgrade col crescere delle esigenze.

Chiusura automatica delle sezioni barra.

Designed for entry-level guidance, the GPS System offers Horizon software in a simple, easy-to-use format. A full color 3D touchscreen offers moving map guidance or autosteering, as well as a virtual on-screen lightbar. Full-featured for its size, the GPS System offers a modular design with on-screen navigation menus, a range of steering patterns, plus coverage mapping and return-to-point.

Features:

- Full range of manual and autoguidance patterns
- Simple, intuitive, icon-based, user-definable interface
- Easy setup on leading market vehicles
- Bright, sunlight-readable display
- Easy-to-learn, easy-to-use, easy-to-ugrade as needs grow

Self-closing bar sections.

Conçu pour le guidage d'entrée de gamme, le GPS System met à disposition le logiciel Horizon dans un format pratique, simple d'utilisation. Un écran tactile 3D couleur complet offre le guidage automatique ou manuel par rapport à une carte, ainsi qu'une barre à l'écran virtuelle. Parfaitement équipé malgré sa taille, le GPS System offre une conception modulaire, avec des menus de navigation à l'écran, une gamme de modèles de direction, et la couverture de cartographie et le retour à un point.

Caractéristiques :

- Une gamme complète de schémas de direction manuelle et d'autoguidage
- Une interface simple, intuitive, basée sur des icônes configurables par l'utilisateur
- Une configuration facile sur les véhicules leader sur le marché
- Un écran lumineux, lisible même au soleil
- Simple à maîtriser, simple d'utilisation, facile à mettre à niveau en fonction des besoins

Fermeture automatique des sections de barre.



Campo di impiego Use / Utilisation



Part No.	Description	Display	USB Plug	Pack
8400002	GPS Navigator X14	4,3"	✓	1
8400003	GPS Navigator X25	8,4"	✓	1

FEATURES

Language	Display Type	kg	°C	V dc	A	Protection
Multilingual	Touch Screen 24 bit color	~1	-25 +65	9 - 36	< 8	IP 67

Composizione del kit / Kit composed of / Composition du kit

A Monitor Monitor Monitor	D Antenna GPS GPS antenna Antenne GPS
B Cavo alimentazione + collegamento Monitor - Antenna Power cable + Connecting cable Monitor - Antenna Câble d'alimentation + Branchement écran - Antenne	E Staffa da palo + Braccio + Supporto a sfera per fissaggio monitor Pole bracket + Arm + Monitor holder with ball Bride de montant + Bras + Support à bille pour fixation moniteur
C Cavo adattatore navigatore - GeoSystem 260 GeoSystem 260 controller adapter cable Câble adaptateur GPS - GeoSystem 260	



A



B



C



D



E

INSTALLATION

GPS System

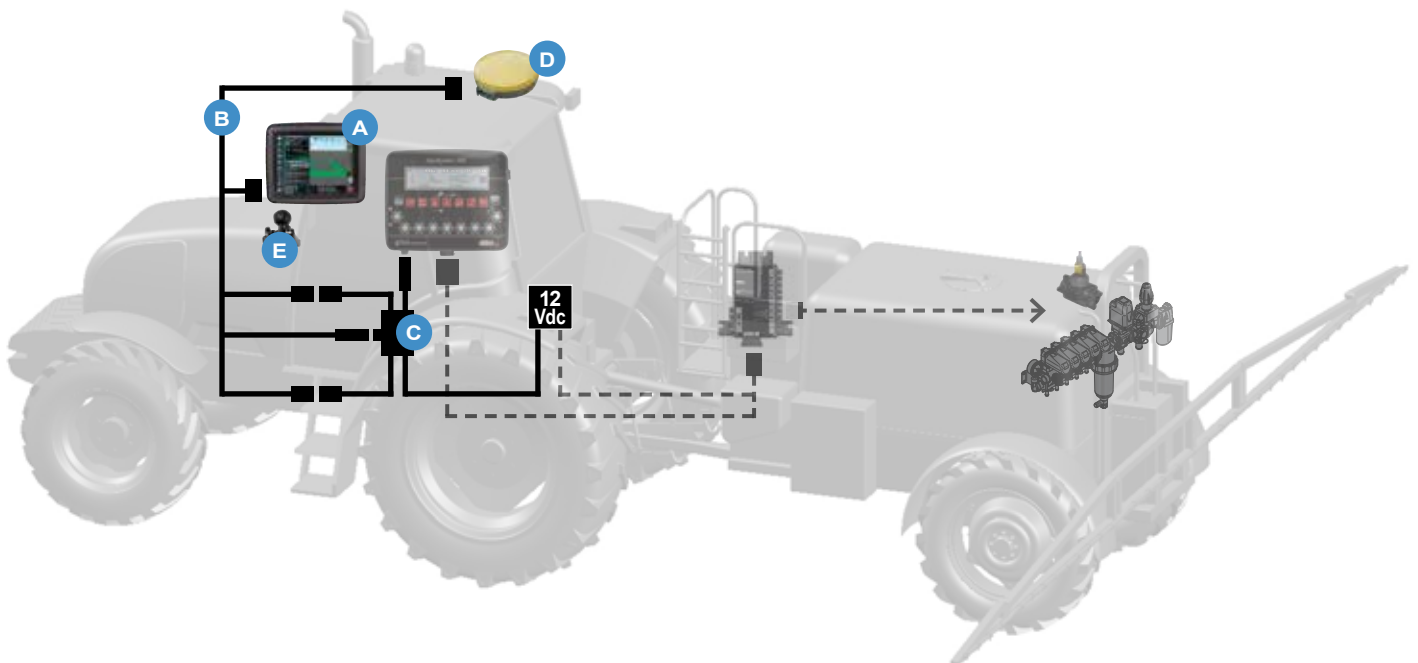













GeoSystem 260 CS



Part No.	Section Valves (W)	Description	Pack
8410054	3	GeoSystem 260 3W CS	1
8410055	4	GeoSystem 260 4W CS	1
8410056	5	GeoSystem 260 5W CS	1
8410057	7	GeoSystem 260 7W CS	1

FEATURES

 Display Dimension 123 x 30.4 mm	 Display Resolution 280 x 64 pixel	 Display Type FSTN Graphical Monochromatic	 Display Light White Backlight	 USB plug <input checked="" type="checkbox"/>
 Language IT-EN-ES FR-DE-PT RU-PL-FI	 kg ~1	 °C -20 +70	 V dc 9.5 - 32	 A < 0,5
	 Protection IP 67	 case PA66 GF 30		

DIMENSIONS

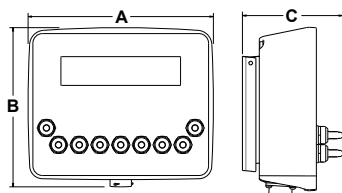

AxBxC mm
192x165x97,5

Campo di impiego / Use / Utilisation



Composizione del kit / Kit composed of / Composition du kit

SPARE PARTS Pag. 50-51

A Monitor Monitor Monitor		I Cavo collegamento tracciefile Foam marker connecting cable Câble de branchement traceur de files	L = 0,4 m
B Scatola di derivazione Driver Box W Connecting box: Driver Box W Boîtier de dérivation Driver Box W		J Cavo adattatore flussometro Flow meter adapter cable Câble adaptateur débitmètre	L = 0,5 m
D Cavo collegamento Monitor - Driver Box W Connecting cable Monitor - Driver Box W Câble de branchement Monitor - Driver Box W	L = 5,0 m	K Sensore di velocità Speed sensor Capteur de vitesse	L = 5,0 m
F Cavo collegamento valvole: Sezione, Generale, Proporzionale Connecting cable to valves: Section, Main, Proportional Câble de branchement vannes: section, générale, proportionnelle	L = 1,2 m	L Staffa di fissaggio Mounting bracket Bride de fixation	

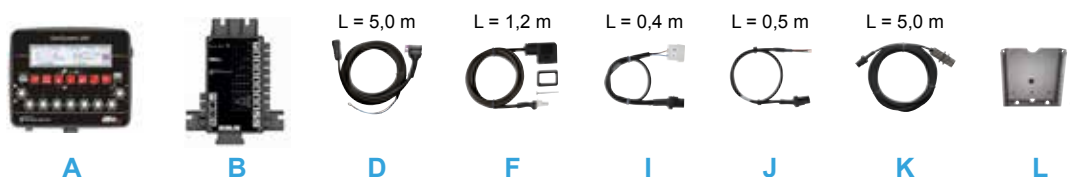

INSTALLATION

GS 260 CS

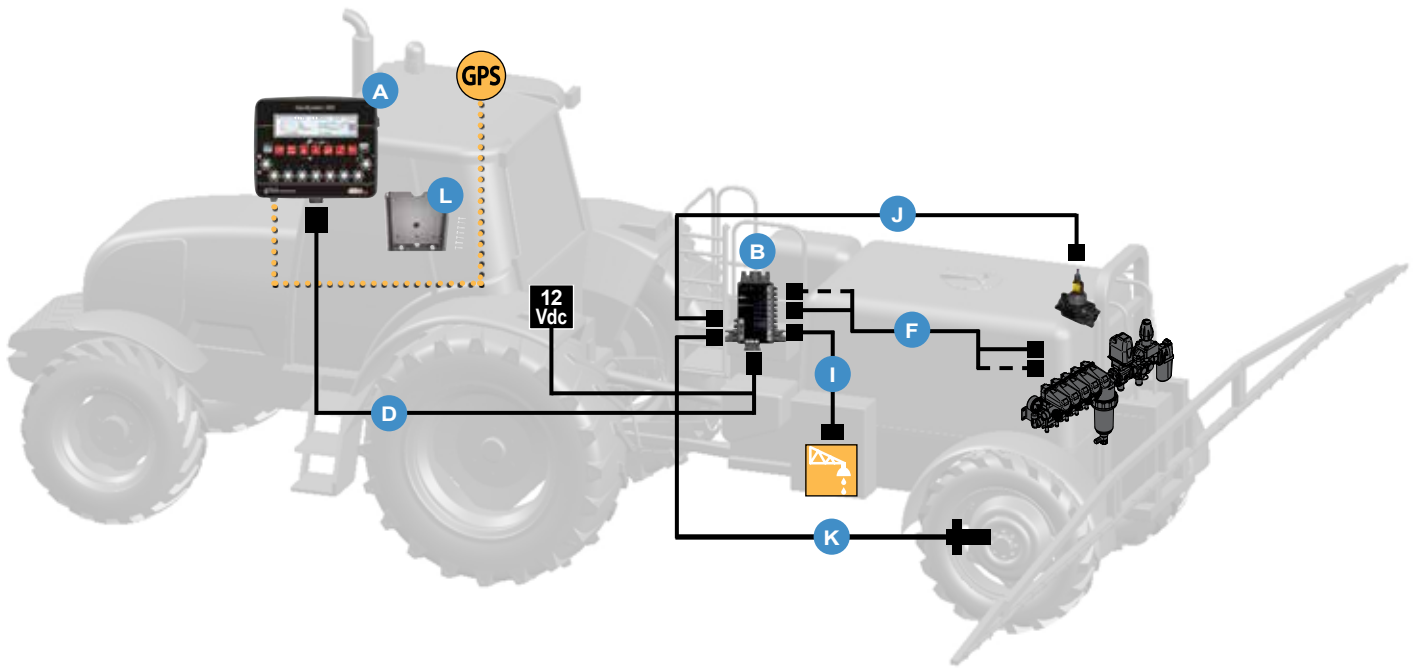

OPTIONALS

PAGE			PAGE		
46	Antenna GPS GPS antenna Antenne GPS		43	Cavo collegamento Monitor - Driver Box W Monitor-Driver Box W connecting cable Câble de branchement moniteur - Driver Box W	L = 11,0 m
111-114	Flussometro Flowmeter Débitmètre		44	Cavo collegamento valvole: Sezione, Generale, Proporzionale Connecting cable to valves: Section, General, Proportional Câble de branchement vannes : section, générale, proportionnelle	L = 6,0 m L = 10,0 m
112	Sensore di flusso Flow sensor Capteur de débi		45	Prolunga per cavo collegamento Monitor - Driver Box W Extension for Monitor-Driver Box W connecting cable Rallonge pour câble de branchement Moniteur - Driver Box	L=3,0 m L=5,0 m
51	Cavo adattatore flussometro Flow meter adapter cable Câble adaptateur débitmètre	L = 0,5 m	45	Prolunga per cavo collegamento Monitor - Driver Box H Extension for Monitor-Driver Box H connecting cable Rallonge pour câble de branchement Moniteur - Driver Box	L=3,0 m L=5,0 m
42	Sensore di pressione Pressure sensor Capteur de pression	20 bar 4-20 mA L = 5,0 m	47	Staffa ventosa con sfera + Supporto a sfera per fissaggio monitor Suction cup bracket with ball + Monitor holder with ball Bride ventouse à bille + Support à bille pour fixation moniteur	
42	Sensore di pressione Pressure sensor Capteur de pression	50 bar 4-20 mA L = 5,0 m	47	Staffa da palo con sfera (senza braccio di completamento) Pole bracket with ball (without supplementary arm) Bride de montant à bille (sans bras complémentaire)	
42	Sensore di pressione Pressure sensor Capteur de pression	100 bar 4-20 mA L = 5,0 m	48	Staffa da palo + Braccio + Supporto a sfera per fissaggio monitor Pole bracket + Arm + Monitor holder with ball Bride de montant + Bras + Support à bille pour fixation moniteur	
42	Cavo adattatore sensore di pressione Pressure sensor adapter cable Câble adaptateur capteur de pression	L = 0,5 m	48	Braccio + Supporto a sfera per fissaggio monitor Arm + Monitor holder with ball Bras + Support à bille pour fixation moniteur	
42	Sensore di livello completo di supporto per fissaggio Level sensor complete with mounting bracket Capteur de niveau avec support de fixation	L = 0,5 m	48	Supporto a sfera per fissaggio monitor Monitor holder with ball Support à bille pour fixation moniteur	
43	Cavo collegamento Sensore di livello - Driver Box Level sensor-Driver Box connecting cable Câble de branchement capteur de niveau - Driver Box	L = 5,0 m	49	Kit collegamento tracciabile Foam marker connecting kit Kit de connexion du traceur	
43	Cavo adattatore sensore di livello Level sensor adapter cable Câble adaptateur capteur de niveau	L = 0,5 m	47	Cavo collegamento GS260 con navigatore GPS (T.U.V.R. Trimble®) GS260 connection cable with GPS satnav (T.U.V.R. Trimble®) Câble de branchement GS260 avec navigateur GPS (T.U.V.R. Trimble®)	L=2,0 m

GeoSystem 260 CS H



Part No.	Section Valves (W)	Hydraulic Valves (H)	Description	Pack
8410058	5	5	GeoSystem 260 5W CS 5H	1
8410059	7	7	GeoSystem 260 7W CS 7H	1

FEATURES

Display Dimension 123 x 30.4 mm	Display Resolution 280 x 64 pixel	Display Type FSTN Graphical Monochromatic	Display Light White Backlight	USB plug ✓
Language IT-EN-ES FR-DE-PT RU-PL-FI	kg ~1	°C -20 +70	V dc 9.5 - 32	A < 0,5
		Protection IP 67	case PA66 GF 30	

DIMENSIONS

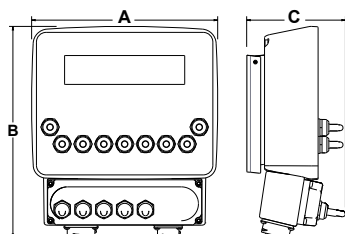

AxBxC mm
192x165x104,5

Campo di impiego / Use / Utilisation

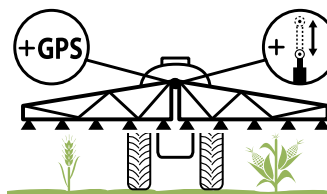

Composizione del kit / Kit composed of / Composition du kit

SPARE PARTS Pag. 50-51

A Monitor Monitor Monitor		G Cavo collegamento valvola Generale Oleodinamica Connecting cable for main hydraulic valve Câble de branchement vanne générale oléohydraulique	L = 1,4 m
B Scatola di derivazione Driver Box W Connecting box: Driver Box W Boîtier de dérivation Driver Box W		H Cavo collegamento valvola Sezione Oleodinamica Connecting cable for hydraulic section valve Câble de branchement vanne de section oléohydraulique	L = 1,2 m
C Scatola di derivazione Driver Box H Connecting box: Driver Box H Boîtier de dérivation Driver Box H		I Cavo collegamento tracciale Foam marker connecting cable Câble de branchement traceur de files	L = 0,4 m
D Cavo collegamento Monitor - Driver Box W Connecting cable Monitor - Driver Box W Câble de branchement Monitor - Driver Box W	L = 5,0 m	J Cavo adattatore flussometro Flow meter adapter cable Câble adaptateur débitmètre	L = 0,5 m
E Cavo collegamento Monitor - Driver Box H Connecting cable Monitor - Driver Box H Câble de branchement Monitor - Driver Box H	L = 5,0 m	K Sensore di velocità Speed sensor Capteur de vitesse	L = 5,0 m
F Cavo collegamento valvole: Sezione, Generale, Proporzionale Connecting cable to valves: Section, Main, Proportional Câble de branchement vannes: section, générale, proportionnelle	L = 1,2 m	L Staffa di fissaggio Mounting bracket Bride de fixation	

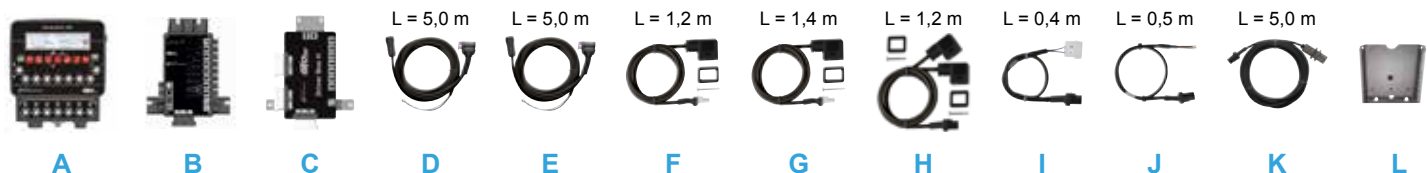

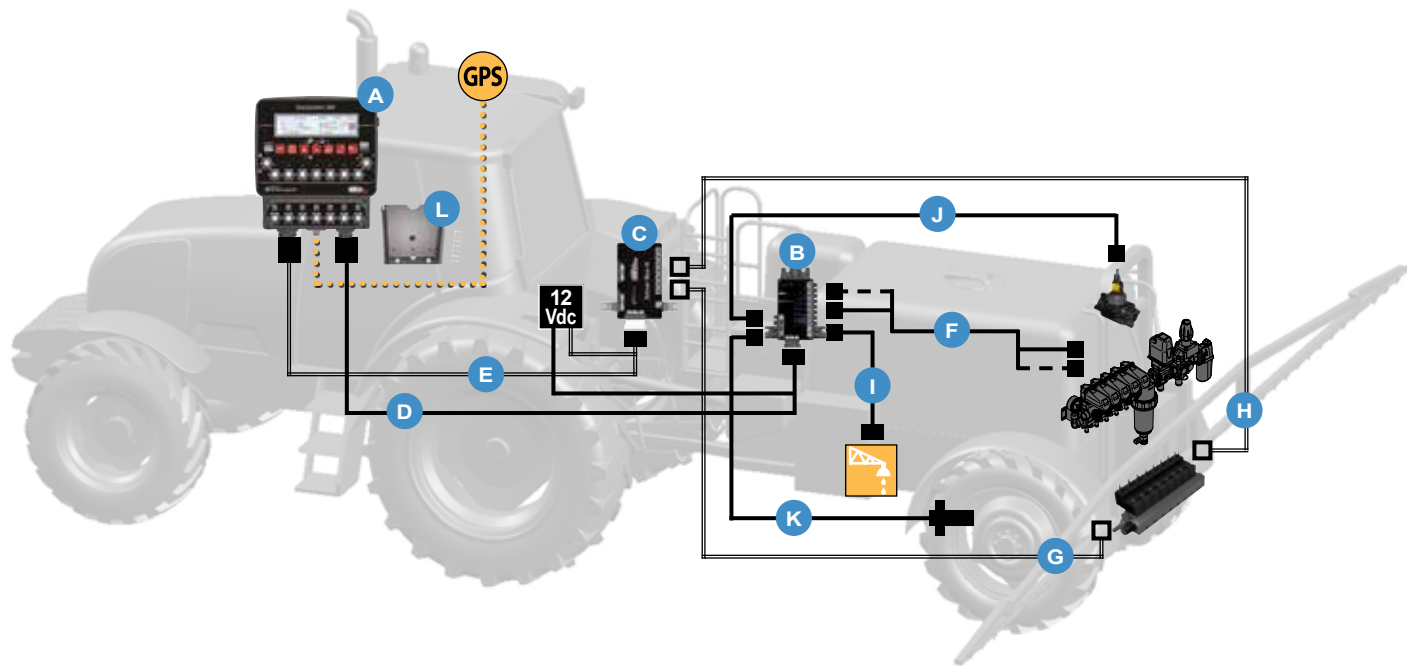

INSTALLATION

GS 260 CS H



OPTIONALS

PAGE		PAGE	
46	Antenna GPS GPS antenna Antenne GPS		43 Cavo collegamento Monitor - Driver Box W Monitor-Driver Box W connecting cable Câble de branchement moniteur - Driver Box W L = 11,0 m
111-114	Flussometro Flowmeter Débitmètre		44 Cavo collegamento valvole: Sezione, Generale, Proporzionale Connecting cable to valves: Section, General, Proportional Câble de branchement vannes : section, générale, proportionnelle L = 6,0 m L = 10,0 m
112	Sensore di flusso Flow sensor Capteur de débi		45 Prolunga per cavo collegamento Monitor - Driver Box W Extension for Monitor-Driver Box W connecting cable Rallonge pour câble de branchement Moniteur - Driver Box L=3,0 m L=5,0 m
51	Cavo adattatore flussometro Flow meter adapter cable Câble adaptateur débitmètre L = 0,5 m		45 Prolunga per cavo collegamento Monitor - Driver Box H Extension for Monitor-Driver Box H connecting cable Rallonge pour câble de branchement Moniteur - Driver Box L=3,0 m L=5,0 m
42	Sensore di pressione Pressure sensor Capteur de pression 20 bar 4-20 mA L = 5,0 m		47 Staffa ventosa con sfera + Supporto a sfera per fissaggio monitor Suction cup bracket with ball + Monitor holder with ball Bride ventouse à bille + Support à bille pour fixation moniteur
42	Sensore di pressione Pressure sensor Capteur de pression 50 bar 4-20 mA L = 5,0 m		47 Staffa da palo con sfera (senza braccio di completamento) Pole bracket with ball (without supplementary arm) Bride de montant à bille (sans bras complémentaire)
42	Sensore di pressione Pressure sensor Capteur de pression 100 bar 4-20 mA L = 5,0 m		48 Staffa da palo + Braccio + Supporto a sfera per fissaggio monitor Pole bracket + Arm + Monitor holder with ball Bride de montant + Bras + Support à bille pour fixation moniteur
42	Cavo adattatore sensore di pressione Pressure sensor adapter cable Câble adaptateur capteur de pression L = 0,5 m		48 Braccio + Supporto a sfera per fissaggio monitor Arm + Monitor holder with ball Bras + Support à bille pour fixation moniteur
42	Sensore di livello completo di supporto per fissaggio Level sensor complete with mounting bracket Capteur de niveau avec support de fixation L = 0,5 m		48 Supporto a sfera per fissaggio monitor Monitor holder with ball Support à bille pour fixation moniteur
43	Cavo collegamento Sensore di livello - Driver Box Level sensor-Driver Box connecting cable Câble de branchement capteur de niveau - Driver Box L = 5,0 m		49 Kit collegamento tracciafile Foam marker connecting kit Kit de connexion du traceur 
43	Cavo adattatore sensore di livello Level sensor adapter cable Câble adaptateur capteur de niveau L = 0,5 m		47 Cavo collegamento GS260 con navigatore GPS (T.U.V.R. Trimble®) GS260 connection cable with GPS satnav (T.U.V.R. Trimble®) Câble de branchement GS260 avec navigateur GPS (T.U.V.R. Trimble®) L=2,0 m

GeoSystem 260 OS



Part No.	Section Valves (W)	Description	Pack
8410047	2	GeoSystem 260 2W OS	1
8410048	4	GeoSystem 260 4W OS	1

FEATURES

Display Dimension 123 x 30.4 mm	Display Resolution 280 x 64 pixel	Display Type FSTN Graphical Monochromatic	Display Light White Backlight	USB plug ✓
Language IT-EN-ES FR-DE-PT RU-PL-FI	kg ~1	°C -20 +70	V dc 9.5 - 32	A < 0,5
	Protection IP 67	case PA66 GF 30		

DIMENSIONS

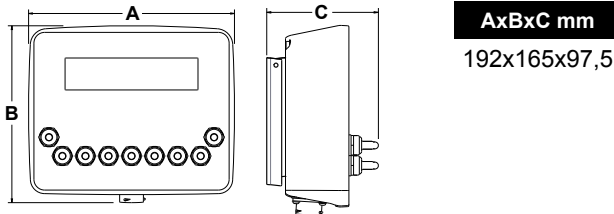

Campo di impiego / Use / Utilisation



Composizione del kit / Kit composed of / Composition du kit

SPARE PARTS Pag. 50-51

A Monitor Monitor Monitor	J Cavo adattatore flussometro Flow meter adapter cable Câble adaptateur débitmètre	L = 0,5 m
B Scatola di derivazione Driver Box W Connecting box: Driver Box W Boîtier de dérivation Driver Box W	K Sensore di velocità Speed sensor Capteur de vitesse	L = 5,0 m
D Cavo collegamento Monitor - Driver Box W Connecting cable Monitor - Driver Box W Câble de branchement Monitor - Driver Box W	L Staffa di fissaggio Mounting bracket Bride de fixation	L = 5,0 m
F Cavo collegamento valvole: Sezione, Generale, Proporzionale Connecting cable to valves: Section, Main, Proportional Câble de branchement vannes: section, générale, proportionnelle		L = 1,2 m

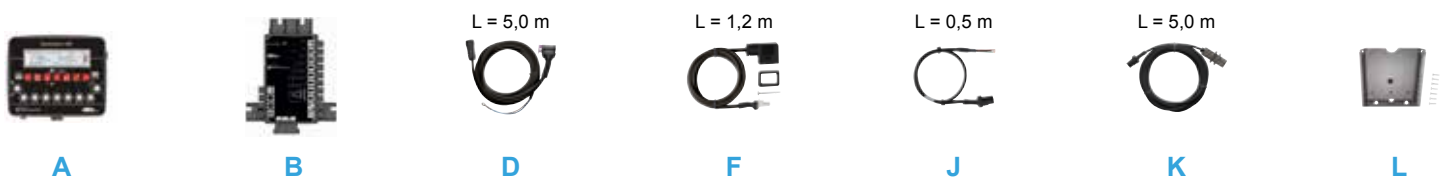

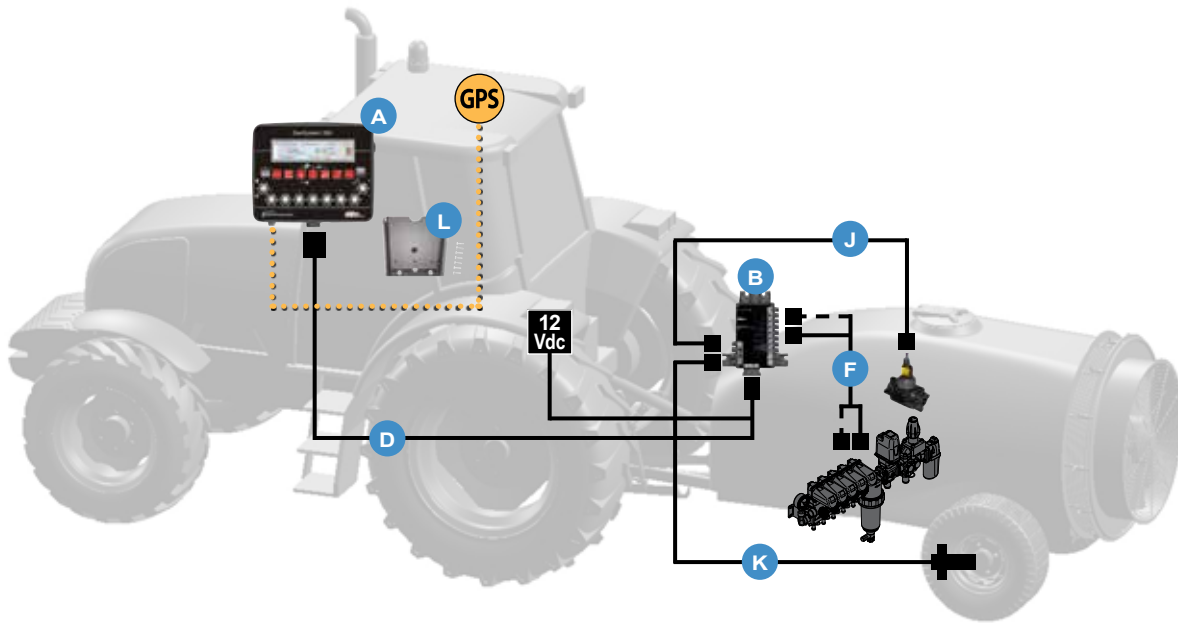

OPTIONALS

PAGE		PAGE			
46	Antenna GPS GPS antenna Antenne GPS		43	Cavo adattatore sensore di livello Level sensor adapter cable Câble adaptateur capteur de niveau	L = 0,5 m
111-114	Flussometro Flowmeter Débitmètre		43	Cavo collegamento Monitor - Driver Box W Monitor-Driver Box W connecting cable Câble de branchement moniteur - Driver Box W	L = 11,0 m
112	Sensore di flusso Flow sensor Capteur de débi		44	Cavo collegamento valvole: Sezione, Generale, Proporzionale Connecting cable to valves: Section, General, Proportional Câble de branchement vannes : section, générale, proportionnelle	L = 6,0 m L = 10,0 m
51	Cavo adattatore flussometro Flow meter adapter cable Câble adaptateur débitmètre	L = 0,5 m	45	Prolunga per cavo collegamento Monitor - Driver Box W Extension for Monitor-Driver Box W connecting cable Rallonge pour câble de branchement Moniteur - Driver Box	L=3,0 m L=5,0 m
42	Sensore di pressione Pressure sensor Capteur de pression	20 bar 4-20 mA L = 5,0 m	45	Prolunga per cavo collegamento Monitor - Driver Box H Extension for Monitor-Driver Box H connecting cable Rallonge pour câble de branchement Moniteur - Driver Box	L=3,0 m L=5,0 m
42	Sensore di pressione Pressure sensor Capteur de pression	50 bar 4-20 mA L = 5,0 m	47	Staffa ventosa con sfera + Supporto a sfera per fissaggio monitor Suction cup bracket with ball + Monitor holder with ball Bride ventouse à bille + Support à bille pour fixation moniteur	
42	Sensore di pressione Pressure sensor Capteur de pression	100 bar 4-20 mA L = 5,0 m	47	Staffa da palo con sfera (senza braccio di completamento) Pole bracket with ball (without supplementary arm) Bride de montant à bille (sans bras complémentaire)	
42	Cavo adattatore sensore di pressione Pressure sensor adapter cable Câble adaptateur capteur de pression	L = 0,5 m	48	Staffa da palo + Braccio + Supporto a sfera per fissaggio monitor Pole bracket + Arm + Monitor holder with ball Bride de montant + Bras + Support à bille pour fixation moniteur	
42	Sensore di livello completo di supporto per fissaggio Level sensor complete with mounting bracket Capteur de niveau avec support de fixation	L = 0,5 m	48	Braccio + Supporto a sfera per fissaggio monitor Arm + Monitor holder with ball Bras + Support à bille pour fixation moniteur	
43	Cavo collegamento Sensore di livello - Driver Box Level sensor-Driver Box connecting cable Câble de branchement capteur de niveau - Driver Box	L = 5,0 m	48	Supporto a sfera per fissaggio monitor Monitor holder with ball Support à bille pour fixation moniteur	

GeoSystem 260 MRS

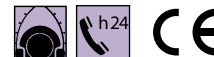

Part No.	Section Valves (W)	Hydraulic Valves (H)	Description	Pack
8410049	2	/	GeoSystem 260 2W MRS	1
8410050	3	/	GeoSystem 260 3W MRS	1
8410051	4	/	GeoSystem 260 4W MRS	1
8410052	5	/	GeoSystem 260 5W MRS	1
8410053	5	5	GeoSystem 260 5W MRS 5H	1

FEATURES

Display Dimension 123 x 30.4 mm	Display Resolution 280 x 64 pixel	Display Type FSTN Graphical Monochromatic	Display Light White Backlight	USB plug ✓
Language IT-EN-ES FR-DE-PT RU-PL-FI	kg ~1	°C -20 +70	V dc 9.5 - 32	A < 0,5
			Protection IP 67	case PA66 GF 30

DIMENSIONS

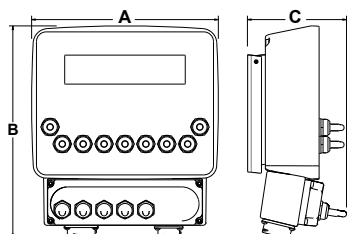

AxBxC mm	
W	192x165x97,5
W+H	192x165x104,5

Campo di impiego / Use / Utilisation



Composizione del kit / Kit composed of / Composition du kit

SPARE PARTS Pag. 50-51

A Monitor Monitor Monitor		G Cavo collegamento valvola Generale Oleodinamica Connecting cable for main hydraulic valve Câble de branchement vanne générale oléohydraulique	L = 1,4 m
B Scatola di derivazione Driver Box W Connecting box: Driver Box W Boîtier de dérivation Driver Box W		H Cavo collegamento valvola Sezione Oleodinamica Connecting cable for hydraulic section valve Câble de branchement vanne de section oléohydraulique	L = 1,2 m
C Scatola di derivazione Driver Box H Connecting box: Driver Box H Boîtier de dérivation Driver Box H		J Cavo adattatore flussometro Flow meter adapter cable Câble adaptateur débitmètre	L = 0,5 m
D Cavo collegamento Monitor - Driver Box W Connecting cable Monitor - Driver Box W Câble de branchement Monitor - Driver Box W	L = 5,0 m	K Sensore di velocità Speed sensor Capteur de vitesse	L = 5,0 m
E Cavo collegamento Monitor - Driver Box H Connecting cable Monitor - Driver Box H Câble de branchement Monitor - Driver Box H	L = 5,0 m	L Staffa di fissaggio Mounting bracket Bride de fixation	
F Cavo collegamento valvole: Sezione, Generale, Proporzionale Connecting cable to valves: Section, Main, Proportional Câble de branchement vannes: section, générale, proportionnelle	L = 1,2 m		

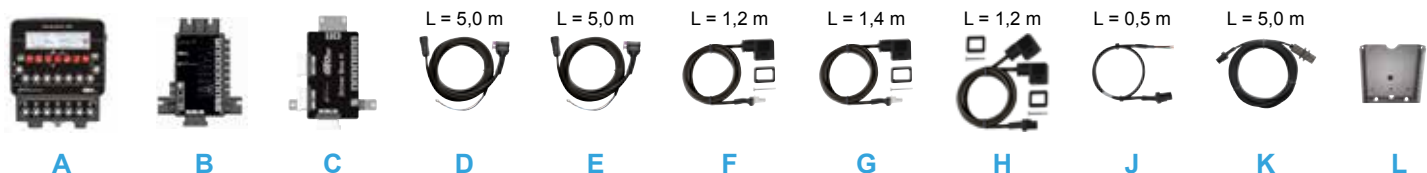

INSTALLATION

GS 260 MRS

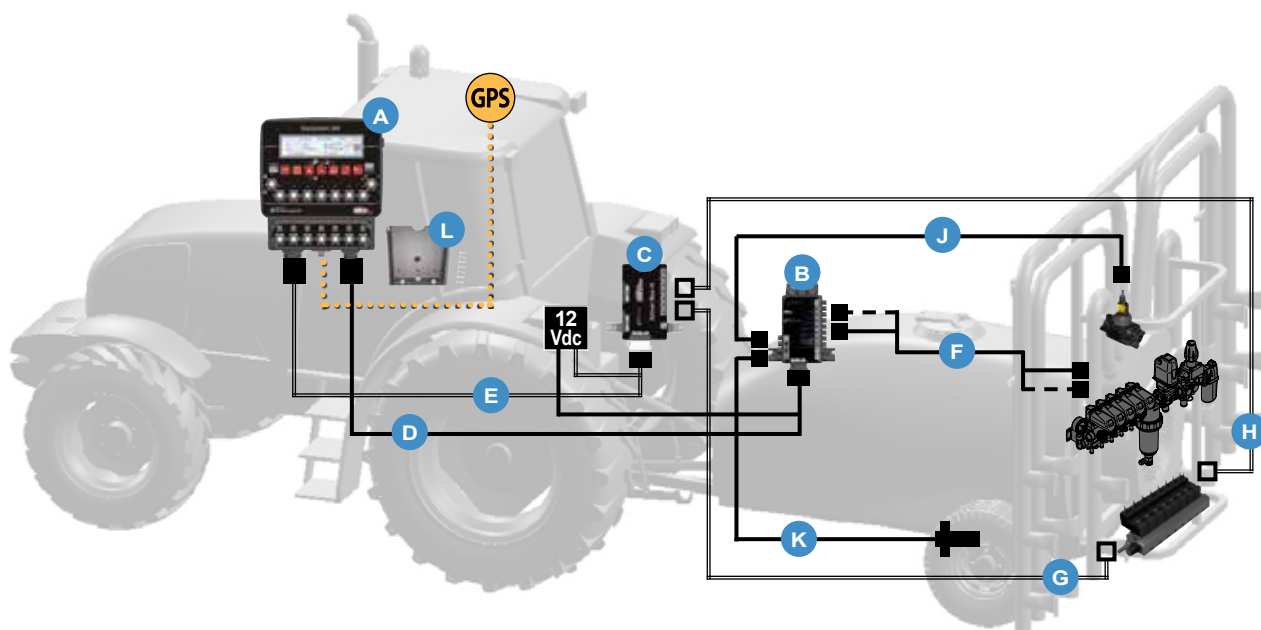

OPTIONALS

PAGE		PAGE	
46	Antenna GPS GPS antenna Antenne GPS		43 Cavo adattatore sensore di livello Level sensor adapter cable Câble adaptateur capteur de niveau L = 0,5 m
111-114	Flussometro Flowmeter Débitmètre		43 Cavo collegamento Monitor - Driver Box W Monitor-Driver Box W connecting cable Câble de branchement moniteur - Driver Box W L = 11,0 m
112	Sensore di flusso Flow sensor Capteur de débi		44 Cavo collegamento valvole: Sezione, Generale, Proporzionale Connecting cable to valves: Section, General, Proportional Câble de branchement vannes : section, générale, proportionnelle L = 6,0 m L = 10,0 m
51	Cavo adattatore flussometro Flow meter adapter cable Câble adaptateur débitmètre L = 0,5 m		45 Prolunga per cavo collegamento Monitor - Driver Box W Extension for Monitor-Driver Box W connecting cable Rallonge pour câble de branchement Moniteur - Driver Box L=3,0 m L=5,0 m
42	Sensore di pressione Pressure sensor Capteur de pression 20 bar 4-20 mA L = 5,0 m		45 Prolunga per cavo collegamento Monitor - Driver Box H Extension for Monitor-Driver Box H connecting cable Rallonge pour câble de branchement Moniteur - Driver Box L=3,0 m L=5,0 m
42	Sensore di pressione Pressure sensor Capteur de pression 50 bar 4-20 mA L = 5,0 m		47 Staffa ventosa con sfera + Supporto a sfera per fissaggio monitor Suction cup bracket with ball + Monitor holder with ball Bride ventouse à bille + Support à bille pour fixation moniteur
42	Sensore di pressione Pressure sensor Capteur de pression 100 bar 4-20 mA L = 5,0 m		47 Staffa da palo con sfera (senza braccio di completamento) Pole bracket with ball (without supplementary arm) Bride de montant à bille (sans bras complémentaire)
42	Cavo adattatore sensore di pressione Pressure sensor adapter cable Câble adaptateur capteur de pression L = 0,5 m		48 Staffa da palo + Braccio + Supporto a sfera per fissaggio monitor Pole bracket + Arm + Monitor holder with ball Bride de montant + Bras + Support à bille pour fixation moniteur
42	Sensore di livello completo di supporto per fissaggio Level sensor complete with mounting bracket Capteur de niveau avec support de fixation L = 0,5 m		48 Braccio + Supporto a sfera per fissaggio monitor Arm + Monitor holder with ball Bras + Support à bille pour fixation moniteur
43	Cavo collegamento Sensore di livello - Driver Box Level sensor-Driver Box connecting cable Câble de branchement capteur de niveau - Driver Box L = 5,0 m		48 Supporto a sfera per fissaggio monitor Monitor holder with ball Support à bille pour fixation moniteur



GeoSystem 250

Computer per distribuzione di prodotti fitosanitari, adatto per macchine da diserbo, atomizzatori e multi-filari.

Caratteristiche:

- Versioni: fino a 7 valvole di sezione e 9 valvole idrauliche.
- Funzionamento automatico e manuale.
- Scatola di derivazione (Driver Box) a cablaggio semplificato di rapida installazione.
- Display LCD retroilluminato di grandi dimensioni, leggibile in ogni condizione di luce.
- Menu multilingua
- Inserimento semplificato dei parametri di lavoro
- Memorizzazione parametri di 8 ugelli personalizzati (in aggiunta agli ugelli ISO).
- Unità di misura configurabili: Metrico / US.
- Configurazione di 10 diversi tipi di trattamento.
- Allarmi visivi e sonori
- Strumento di diagnostica integrato
- Gestione tracciafile (solo per versione CS)
- Parametri gestiti: pressione, velocità, portata, area trattata, quantità distribuita, durata del trattamento, distanza percorsa, livello cisterna.

Computer for distributing phytosanitary products, suitable for weed-killing machines, sprayers and multi-row machines.

Features:

- Versions: up to 7 section valves and 9 hydraulic valves.
- Automatic and manual operation.
- Connecting box (Driver Box) with simplified, quick-to-install wiring.
- Large, rear-lit LCD display, legible in all lighting conditions.
- Multilingual menu
- Simplified work parameter entry
- 8 customised nozzle parameter storage (in addition to ISO nozzles).
- Configurable units of measurement: Metric / US.
- Configuration of 10 different types of treatment.
- Visual and acoustic alarms
- Integrated diagnostic tool
- Foam marker management (only for CS version)
- Parameters managed: pressure, speed, flow rate, treated area, distributed quantity, treatment duration, distance travelled, tank level.

Ordinateur de distribution de produits phytosanitaires, adapté aux machines de désherbage, atomiseurs et multifilaires.

Caractéristiques :

- Versions : jusqu'à 7 vannes de section et 9 vannes hydrauliques.
- Fonctionnement automatique et manuel.
- Boîtier de dérivation (Driver Box) à câblage simplifié rapide à installer.
- Écran LCD à rétro-éclairage de grandes dimensions, lisible dans toute condition de luminosité.
- Menu multilingue.
- Saisie simplifiée des paramètres de travail.
- Mémorisation des paramètres de 8 buses personnalisées (outre les buses ISO).
- Unités de mesure configurables : Métrique / US.
- Configuration de 10 types de traitement différents.
- Alarmes visuelles et sonores.
- Instrument de diagnostic intégré.
- Gestion traceur de files (sur version CS uniquement)
- Paramètres gérés : pression, vitesse, débit, superficie traitée, quantité distribuée, durée du traitement, distance parcourue et niveau citerne.

250 CS



Pag. 18

250 CS H



Pag. 20

250 OS



Pag. 22

250 MRS



Pag. 24

GeoSystem 250 CS



Part No.	Section Valves (W)	Description	Pack
8410043	3	GeoSystem 250 3W CS	1
8410044	4	GeoSystem 250 4W CS	1
8410045	5	GeoSystem 250 5W CS	1
8410060	7	GeoSystem 250 7W CS	1

FEATURES

Display Dimension 123 x 30.4 mm	Display Type Alphanumeric 16x2 Monochromatic	Display Light Green Backlight
Language IT-EN-ES FR-DE-PT-RU PL-FI-UK-GR	kg ~1	°C -20 +70
V dc 9.5 - 32	A < 0,5	Protection IP 67
		case PA66 GF 30

DIMENSIONS

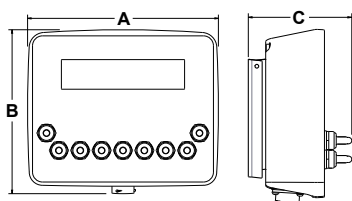

AxBxC mm
192x165x97,5

Campo di impiego / Use / Utilisation

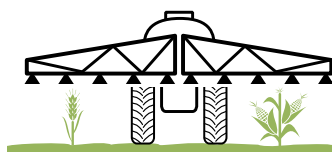

Composizione del kit / Kit composed of / Composition du kit

SPARE PARTS Pag. 50-51

A Monitor Monitor Monitor		I Cavo collegamento tracciabile Foam marker connecting cable Câble de branchement traceur de files	L = 0,4 m
B Scatola di derivazione Driver Box W Connecting box: Driver Box W Boîtier de dérivation Driver Box W		J Cavo adattatore flussometro Flow meter adapter cable Câble adaptateur débitmètre	L = 0,5 m
D Cavo collegamento Monitor - Driver Box W Connecting cable Monitor - Driver Box W Câble de branchement Monitor - Driver Box W	L = 5,0 m	K Sensore di velocità Speed sensor Capteur de vitesse	L = 5,0 m
F Cavo collegamento valvole: Sezione, Generale, Proporzionale Connecting cable to valves: Section, Main, Proportionale Câble de branchement vannes: section, générale, proportionnelle	L = 1,2 m	L Staffa di fissaggio Mounting bracket Bride de fixation	

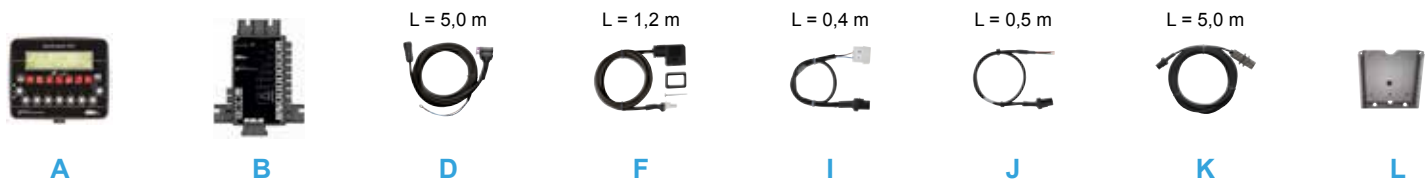

INSTALLATION

GS 250 CS

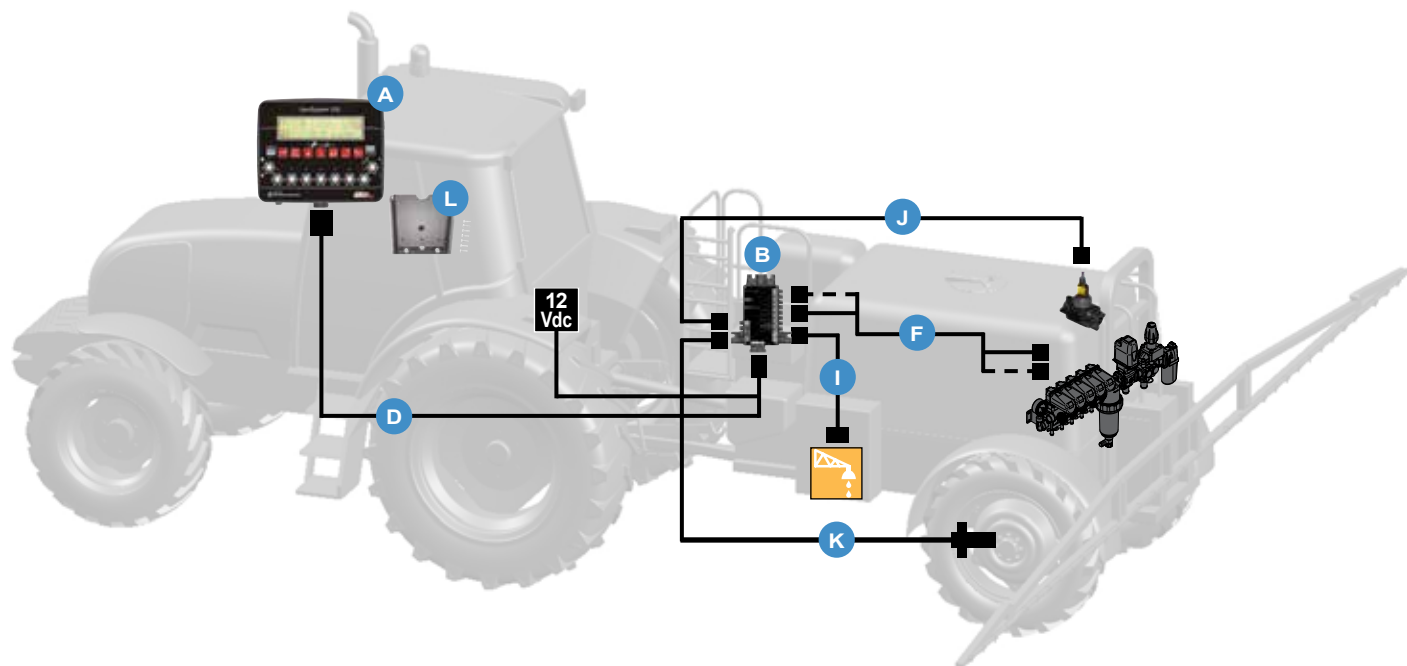

OPTIONALS

PAGE		PAGE	
111-114	Flussometro Flowmeter Débitmètre	43	Cavo collegamento Monitor - Driver Box W Monitor-Driver Box W connecting cable Câble de branchement moniteur - Driver Box W L = 11,0 m
112	Sensore di flusso Flow sensor Capteur de débi	44	Cavo collegamento valvole: Sezione, Generale, Proporzionale Connecting cable to valves: Section, General, Proportional L = 6,0 m Câble de branchement vannes : section, générale, proportionnelle L = 10,0 m
51	Cavo adattatore flussometro Flow meter adapter cable Câble adaptateur débitmètre L = 0,5 m	45	Prolunga per cavo collegamento Monitor - Driver Box W Extension for Monitor-Driver Box W connecting cable L=3,0 m Rallonge pour câble de branchement Moniteur - Driver Box L=5,0 m
42	Sensore di pressione Pressure sensor Capteur de pression 20 bar 4-20 mA L = 5,0 m	45	Prolunga per cavo collegamento Monitor - Driver Box H Extension for Monitor-Driver Box H connecting cable L=3,0 m Rallonge pour câble de branchement Moniteur - Driver Box L=5,0 m
42	Sensore di pressione Pressure sensor Capteur de pression 50 bar 4-20 mA L = 5,0 m	47	Staffa ventosa con sfera + Supporto a sfera per fissaggio monitor Suction cup bracket with ball + Monitor holder with ball Bride ventouse à bille + Support à bille pour fixation moniteur
42	Sensore di pressione Pressure sensor Capteur de pression 100 bar 4-20 mA L = 5,0 m	47	Staffa da palo con sfera (senza braccio di completamento) Pole bracket with ball (without supplementary arm) Bride de montant à bille (sans bras complémentaire)
42	Cavo adattatore sensore di pressione Pressure sensor adapter cable Câble adaptateur capteur de pression L = 0,5 m	48	Staffa da palo + Braccio + Supporto a sfera per fissaggio monitor Pole bracket + Arm + Monitor holder with ball Bride de montant + Bras + Support à bille pour fixation moniteur
42	Sensore di livello completo di supporto per fissaggio Level sensor complete with mounting bracket Capteur de niveau avec support de fixation L = 0,5 m	48	Braccio + Supporto a sfera per fissaggio monitor Arm + Monitor holder with ball Bras + Support à bille pour fixation moniteur
43	Cavo collegamento Sensore di livello - Driver Box Level sensor-Driver Box connecting cable Câble de branchement capteur de niveau - Driver Box L = 5,0 m	48	Supporto a sfera per fissaggio monitor Monitor holder with ball Support à bille pour fixation moniteur
43	Cavo adattatore sensore di livello Level sensor adapter cable Câble adaptateur capteur de niveau L = 0,5 m	49	Kit collegamento tracciafile Foam marker connecting kit Kit de connexion du traceur 

GeoSystem 250 CS H



Part No.	Section Valves (W)	Hydraulic Valves (H)	Description	Pack
8410046	5	5	GeoSystem 250 5W CS 5H	1
8410061	5	7	GeoSystem 250 5W CS 7H	1
8410062	7	7	GeoSystem 250 7W CS 7H	1
8410063	5	2	GeoSystem 250 5W CS 2H	1
8410064	7	2	GeoSystem 250 7W CS 2H	1
8410065	5	9	GeoSystem 250 5W CS 9H	1
8410066	7	9	GeoSystem 250 7W CS 9H	1

FEATURES

Display Dimension 123 x 30.4 mm	Display Type Alphanumeric 16x2 Monochromatic	Display Light Green Backlight
Language IT-EN-ES FR-DE-PT-RU PL-FI-UK-GR	kg ~1	°C -20 +70
V dc 9.5 - 32	A < 0,5	Protection IP 67
	case PA66 GF 30	

DIMENSIONS

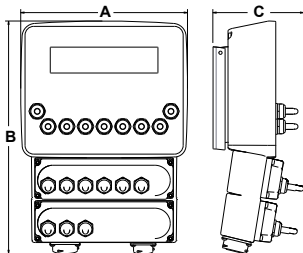

AxBxC mm
192x268x112,5

Campo di impiego / Use / Utilisation



Composizione del kit / Kit composed of / Composition du kit

SPARE PARTS Pag. 50-51

A Monitor Monitor Monitor		G Cavo collegamento valvola Generale Oleodinamica Connecting cable for main hydraulic valve Câble de branchement vanne générale oléohydraulique	L = 1,4 m
B Scatola di derivazione Driver Box W Connecting box: Driver Box W Boîtier de dérivation Driver Box W		H Cavo collegamento valvola Sezione Oleodinamica Connecting cable for hydraulic section valve Câble de branchement vanne de section oléohydraulique	L = 1,2 m
C Scatola di derivazione Driver Box H Connecting box: Driver Box H Boîtier de dérivation Driver Box H		I Cavo collegamento tracciatore Foam marker connecting cable Câble de branchement traceur de files	L = 0,4 m
D Cavo collegamento Monitor - Driver Box W Connecting cable Monitor - Driver Box W Câble de branchement Monitor - Driver Box W	L = 5,0 m	J Cavo adattatore flussometro Flow meter adapter cable Câble adaptateur débitmètre	L = 0,5 m
E Cavo collegamento Monitor - Driver Box H Connecting cable Monitor - Driver Box H Câble de branchement Monitor - Driver Box H	L = 5,0 m	K Sensore di velocità Speed sensor Capteur de vitesse	L = 5,0 m
F Cavo collegamento valvole: Sezione, Generale, Proporzionale Connecting cable to valves: Section, Main, Proportional Câble de branchement vannes: section, générale, proportionnelle	L = 1,2 m	L Staffa di fissaggio Mounting bracket Bride de fixation	

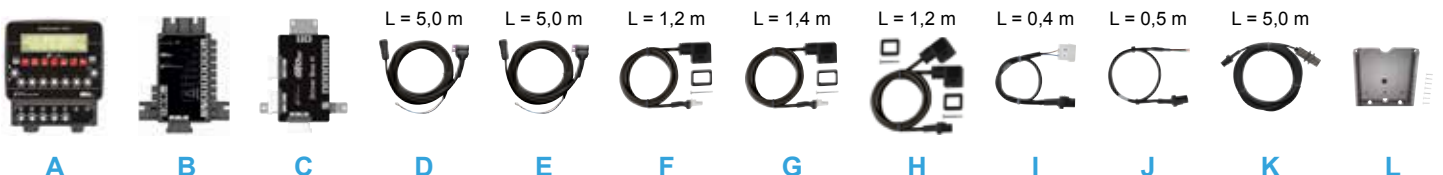

INSTALLATION

GS 250 CS H

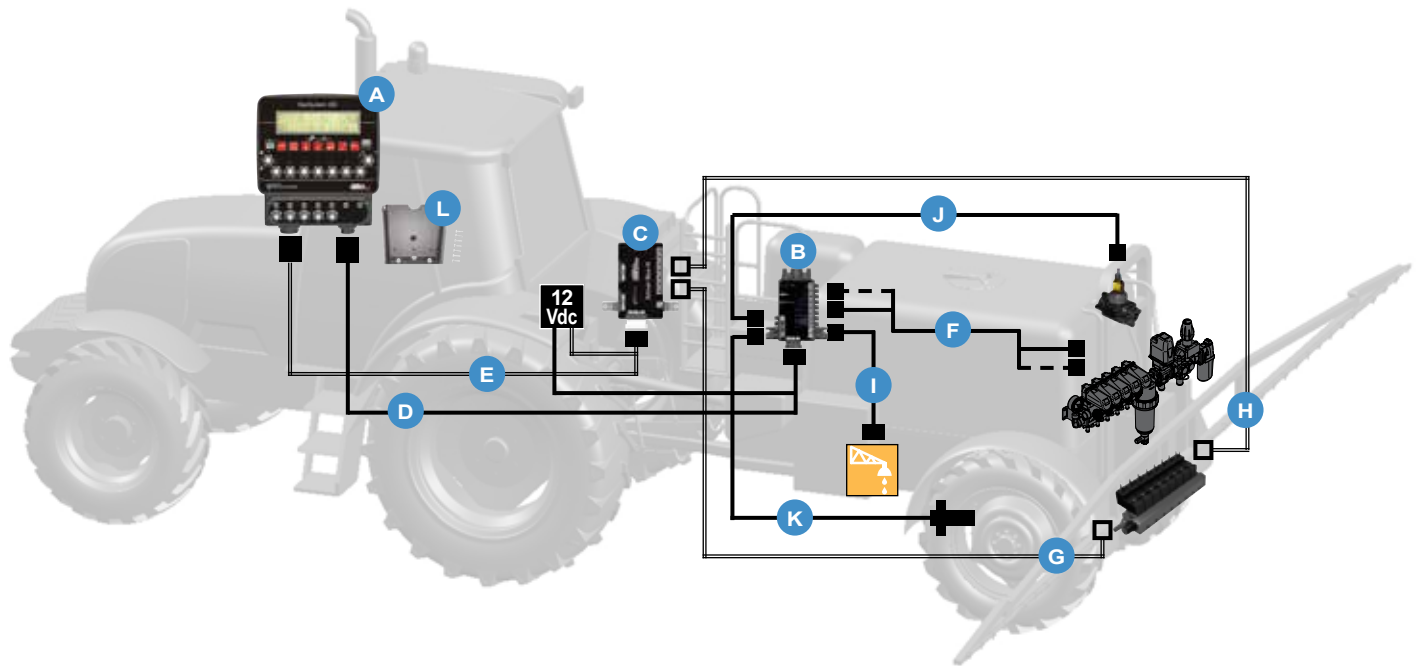

OPTIONALS

PAGE		PAGE	
111-114	Flussometro Flowmeter Débitmètre	43	Cavo collegamento Monitor - Driver Box W Monitor-Driver Box W connecting cable Câble de branchement moniteur - Driver Box W L = 11,0 m
112	Sensore di flusso Flow sensor Capteur de débi	44	Cavo collegamento valvole: Sezione, Generale, Proporzionale Connecting cable to valves: Section, General, Proportional Câble de branchement vannes : section, générale, proportionnelle L = 6,0 m L = 10,0 m
51	Cavo adattatore flussometro Flow meter adapter cable Câble adaptateur débitmètre L = 0,5 m	45	Prolunga per cavo collegamento Monitor - Driver Box W Extension for Monitor-Driver Box W connecting cable Rallonge pour câble de branchement Moniteur - Driver Box L=3,0 m L=5,0 m
42	Sensore di pressione Pressure sensor Capteur de pression 20 bar 4-20 mA L = 5,0 m	45	Prolunga per cavo collegamento Monitor - Driver Box H Extension for Monitor-Driver Box H connecting cable Rallonge pour câble de branchement Moniteur - Driver Box L=3,0 m L=5,0 m
42	Sensore di pressione Pressure sensor Capteur de pression 50 bar 4-20 mA L = 5,0 m	47	Staffa ventosa con sfera + Supporto a sfera per fissaggio monitor Suction cup bracket with ball + Monitor holder with ball Bride ventouse à bille + Support à bille pour fixation moniteur
42	Sensore di pressione Pressure sensor Capteur de pression 100 bar 4-20 mA L = 5,0 m	47	Staffa da palo con sfera (senza braccio di completamento) Pole bracket with ball (without supplementary arm) Bride de montant à bille (sans bras complémentaire)
42	Cavo adattatore sensore di pressione Pressure sensor adapter cable Câble adaptateur capteur de pression L = 0,5 m	48	Staffa da palo + Braccio + Supporto a sfera per fissaggio monitor Pole bracket + Arm + Monitor holder with ball Bride de montant + Bras + Support à bille pour fixation moniteur
42	Sensore di livello completo di supporto per fissaggio Level sensor complete with mounting bracket Capteur de niveau avec support de fixation L = 0,5 m	48	Braccio + Supporto a sfera per fissaggio monitor Arm + Monitor holder with ball Bras + Support à bille pour fixation moniteur
43	Cavo collegamento Sensore di livello - Driver Box Level sensor-Driver Box connecting cable Câble de branchement capteur de niveau - Driver Box L = 5,0 m	48	Supporto a sfera per fissaggio monitor Monitor holder with ball Support à bille pour fixation moniteur
43	Cavo adattatore sensore di livello Level sensor adapter cable Câble adaptateur capteur de niveau L = 0,5 m	49	Kit collegamento tracciafile Foam marker connecting kit Kit de connexion du traceur 

GeoSystem 250 OS



Part No.	Section Valves (W)	Description	Pack
8410037	2	GeoSystem 250 2W OS	1
8410038	4	GeoSystem 250 4W OS	1

FEATURES

Display Dimension 123 x 30.4 mm	Display Type Alphanumeric 16x2 Monochromatic	Display Light Green Backlight				
Language IT-EN-ES FR-DE-PT-RU PL-FI-UK-GR	kg ~1	°C -20 +70	V dc 9.5 - 32	A < 0,5	Protection IP 67	case PA66 GF 30

DIMENSIONS

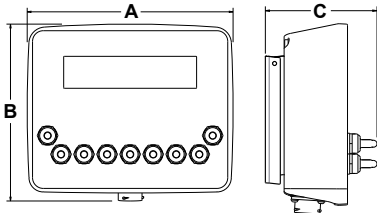

AxBxC mm
192x165x97,5

Campo di impiego / Use / Utilisation



Composizione del kit / Kit composed of / Composition du kit

SPARE PARTS Pag. 50-51

A Monitor Monitor Monitor		J Cavo adattatore flussometro Flow meter adapter cable Câble adaptateur débitmètre	L = 0,5 m
B Scatola di derivazione Driver Box W Connecting box: Driver Box W Boîtier de dérivation Driver Box W		K Sensore di velocità Speed sensor Capteur de vitesse	L = 5,0 m
D Cavo collegamento Monitor - Driver Box W Connecting cable Monitor - Driver Box W Câble de branchement Monitor - Driver Box W	L = 5,0 m	L Staffa di fissaggio Mounting bracket Bride de fixation	
F Cavo collegamento valvole: Sezione, Generale, Proporzionale Connecting cable to valves: Section, Main, Proportional Câble de branchement vannes: section, générale, proportionnelle	L = 1,2 m		



INSTALLATION

GS 250 OS

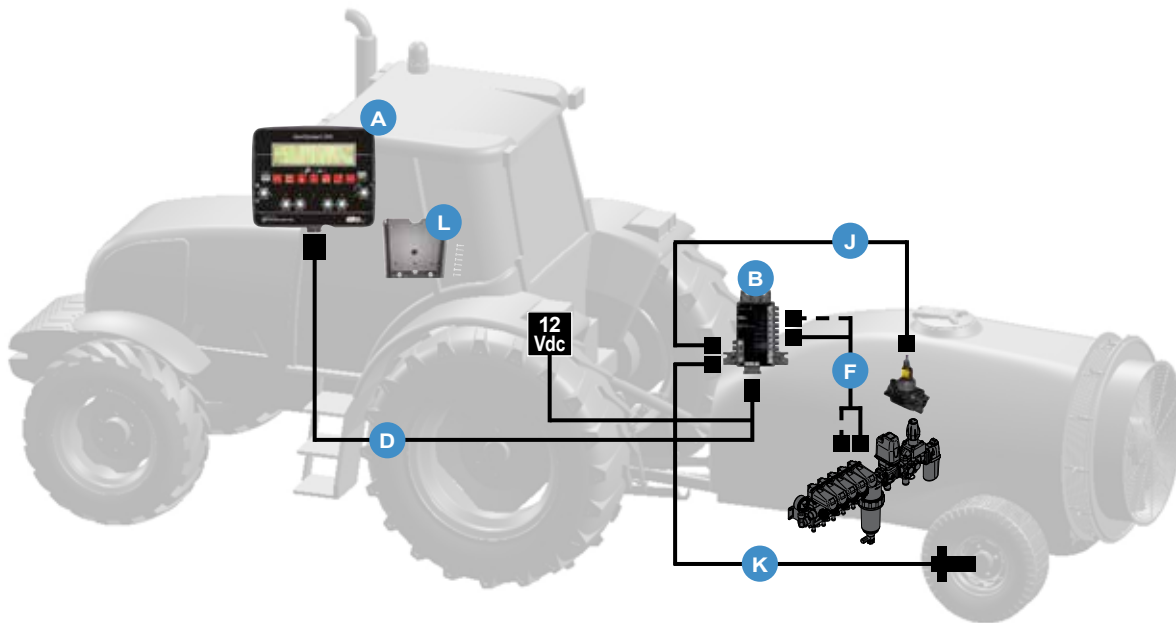

OPTIONALS

PAGE		PAGE	
111-114	Flussometro Flowmeter Débitmètre	43	Cavo collegamento Monitor - Driver Box W Monitor-Driver Box W connecting cable Câble de branchement moniteur - Driver Box W L = 11,0 m
112	Sensore di flusso Flow sensor Capteur de débit	44	Cavo collegamento valvole: Sezione, Generale, Proporzionale Connecting cable to valves: Section, General, Proportional Câble de branchement vannes : section, générale, proportionnelle L = 6,0 m L = 10,0 m
51	Cavo adattatore flussometro Flow meter adapter cable Câble adaptateur débitmètre L = 0,5 m	45	Prolunga per cavo collegamento Monitor - Driver Box W Extension for Monitor-Driver Box W connecting cable Rallonge pour câble de branchement Moniteur - Driver Box L=3,0 m L=5,0 m
42	Sensore di pressione Pressure sensor Capteur de pression 20 bar 4-20 mA L = 5,0 m	45	Prolunga per cavo collegamento Monitor - Driver Box H Extension for Monitor-Driver Box H connecting cable Rallonge pour câble de branchement Moniteur - Driver Box L=3,0 m L=5,0 m
42	Sensore di pressione Pressure sensor Capteur de pression 50 bar 4-20 mA L = 5,0 m	47	Staffa ventosa con sfera + Supporto a sfera per fissaggio monitor Suction cup bracket with ball + Monitor holder with ball Bride ventouse à bille + Support à bille pour fixation moniteur
42	Sensore di pressione Pressure sensor Capteur de pression 100 bar 4-20 mA L = 5,0 m	47	Staffa da palo con sfera (senza braccio di completamento) Pole bracket with ball (without supplementary arm) Bride de montant à bille (sans bras complémentaire)
42	Cavo adattatore sensore di pressione Pressure sensor adapter cable Câble adaptateur capteur de pression L = 0,5 m	48	Staffa da palo + Braccio + Supporto a sfera per fissaggio monitor Pole bracket + Arm + Monitor holder with ball Bride de montant + Bras + Support à bille pour fixation moniteur
42	Sensore di livello completo di supporto per fissaggio Level sensor complete with mounting bracket Capteur de niveau avec support de fixation L = 0,5 m	48	Braccio + Supporto a sfera per fissaggio monitor Arm + Monitor holder with ball Bras + Support à bille pour fixation moniteur
43	Cavo collegamento Sensore di livello - Driver Box Level sensor-Driver Box connecting cable Câble de branchement capteur de niveau - Driver Box L = 5,0 m	48	Supporto a sfera per fissaggio monitor Monitor holder with ball Support à bille pour fixation moniteur
43	Cavo adattatore sensore di livello Level sensor adapter cable Câble adaptateur capteur de niveau L = 0,5 m		

GeoSystem 250 MRS

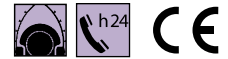

Part No.	Section Valves (W)	Description	Pack
8410039	2	GeoSystem 250 2W MRS	1
8410040	3	GeoSystem 250 3W MRS	1
8410041	4	GeoSystem 250 4W MRS	1
8410042	5	GeoSystem 250 5W MRS	1

FEATURES

Display Dimension 123 x 30.4 mm	Display Type Alphanumeric 16x2 Monochromatic	Display Light Green Backlight
Language IT-EN-ES FR-DE-PT-RU PL-FI-UK-GR	kg ~1	°C -20 +70
V dc 9.5 - 32	A < 0,5	Protection IP 67
		case PA66 GF 30

DIMENSIONS

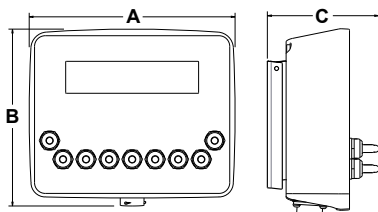

AxBxC mm
192x165x97,5

Campo di impiego / Use / Utilisation

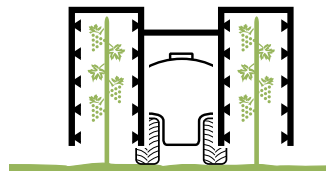

Composizione del kit / Kit composed of / Composition du kit

SPARE PARTS Pag. 50-51

A Monitor Monitor Monitor	J Cavo adattatore flussometro Flow meter adapter cable Câble adaptateur débitmètre	L = 0,5 m
B Scatola di derivazione Driver Box W Connecting box: Driver Box W Boîtier de dérivation Driver Box H	K Sensore di velocità Speed sensor Capteur de vitesse	L = 5,0 m
D Cavo collegamento Monitor - Driver Box W Connecting cable Monitor - Driver Box W Câble de branchement Monitor - Driver Box W	L Staffa di fissaggio Mounting bracket Bride de fixation	L = 5,0 m
F Cavo collegamento valvole: Sezione, Generale, Proporzionale Connecting cable to valves: Section, Main, Proportional Câble de branchement vannes: section, générale, proportionnelle		L = 1,2 m



A



B



D



F

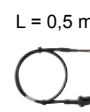

J



K



L

INSTALLATION

GS 250 MRS

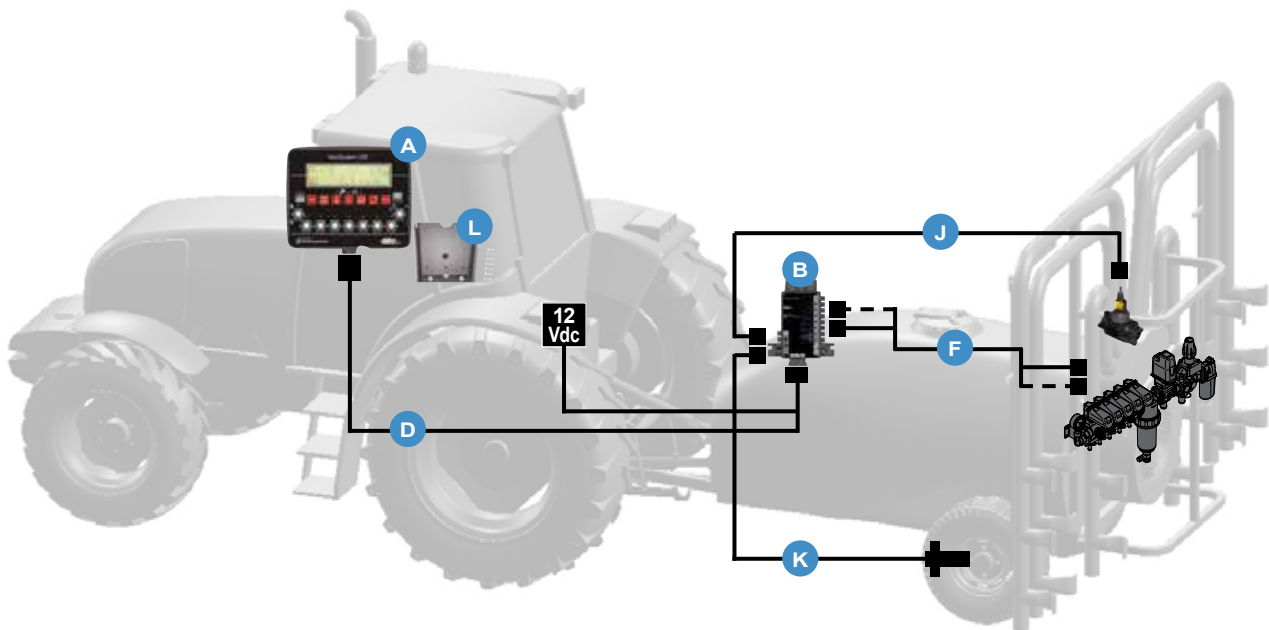

OPTIONALS

PAGE		PAGE	
111-114	Flussometro Flowmeter Débitmètre	43	Cavo collegamento Monitor - Driver Box W Monitor-Driver Box W connecting cable Câble de branchement moniteur - Driver Box W L = 11,0 m
112	Sensore di flusso Flow sensor Capteur de débi	44	Cavo collegamento valvole: Sezione, Generale, Proporzionale Connecting cable to valves: Section, General, Proportional Câble de branchement vannes : section, générale, proportionnelle L = 6,0 m L = 10,0 m
51	Cavo adattatore flussometro Flow meter adapter cable Câble adaptateur débitmètre L = 0,5 m	45	Prolunga per cavo collegamento Monitor - Driver Box W Extension for Monitor-Driver Box W connecting cable Rallonge pour câble de branchement Moniteur - Driver Box L=3,0 m L=5,0 m
42	Sensore di pressione Pressure sensor Capteur de pression 20 bar 4-20 mA L = 5,0 m	45	Prolunga per cavo collegamento Monitor - Driver Box H Extension for Monitor-Driver Box H connecting cable Rallonge pour câble de branchement Moniteur - Driver Box L=3,0 m L=5,0 m
42	Sensore di pressione Pressure sensor Capteur de pression 50 bar 4-20 mA L = 5,0 m	47	Staffa ventosa con sfera + Supporto a sfera per fissaggio monitor Suction cup bracket with ball + Monitor holder with ball Bride ventouse à bille + Support à bille pour fixation moniteur
42	Sensore di pressione Pressure sensor Capteur de pression 100 bar 4-20 mA L = 5,0 m	47	Staffa da palo con sfera (senza braccio di completamento) Pole bracket with ball (without supplementary arm) Bride de montant à bille (sans bras complémentaire)
42	Cavo adattatore sensore di pressione Pressure sensor adapter cable Câble adaptateur capteur de pression L = 0,5 m	48	Staffa da palo + Braccio + Supporto a sfera per fissaggio monitor Pole bracket + Arm + Monitor holder with ball Bride de montant + Bras + Support à bille pour fixation moniteur
42	Sensore di livello completo di supporto per fissaggio Level sensor complete with mounting bracket Capteur de niveau avec support de fixation L = 0,5 m	48	Braccio + Supporto a sfera per fissaggio monitor Arm + Monitor holder with ball Bras + Support à bille pour fixation moniteur
43	Cavo collegamento Sensore di livello - Driver Box Level sensor-Driver Box connecting cable Câble de branchement capteur de niveau - Driver Box L = 5,0 m	48	Supporto a sfera per fissaggio monitor Monitor holder with ball Support à bille pour fixation moniteur
43	Cavo adattatore sensore di livello Level sensor adapter cable Câble adaptateur capteur de niveau L = 0,5 m		

GeoSystem 220 OS



Visualizzatore per distribuzione di prodotti fitosanitari, adatto per atomizzatori.

Display for distributing phytosanitary products, suitable for sprayers.

Écran de distribution de produits phytosanitaires, adapté aux atomiseurs.

Caratteristiche:

- Versioni: fino a 4 valvole di sezione.
- Funzionamento manuale.
- Cablaggio semplificato di rapida installazione
- Display LCD retroilluminato di grandi dimensioni, leggibile in ogni condizione di luce.
- Menu multilingua
- Inserimento semplificato dei parametri di lavoro
- Memorizzazione parametri di 8 ugelli personalizzati (in aggiunta agli ugelli ISO).
- Unità di misura configurabili: Metrico / US.
- Allarmi visivi e sonori
- Strumento di diagnostica integrato
- Parametri gestiti: pressione, velocità, portata, area trattata, quantità distribuita, durata del trattamento, distanza percorsa, livello cisterna.

Features:

- Versions: up to 4 section valves.
- Manual operation.
- Quick-to-install wiring
- Large, rear-lit LCD display, legible in all lighting conditions.
- Multilingual menu
- Simplified work parameter entry
- 8 customised nozzle parameter storage (in addition to ISO nozzles).
- Configurable units of measurement: Metric / US.
- Visual and acoustic alarms
- Integrated diagnostic tool
- Parameters managed: pressure, speed, flow rate, treated area, distributed quantity, treatment duration, distance travelled, tank level.

Caractéristiques :

- Versions : jusqu'à 4 vannes de section.
- Fonctionnement manuel.
- Câblage simplifié rapide à installer.
- Écran LCD à rétro-éclairage de grandes dimensions, lisible dans toute condition de luminosité.
- Menu multilingue.
- Saisie simplifiée des paramètres de travail.
- Mémorisation des paramètres de 8 buses personnalisées (outre les buses ISO).
- Unités de mesure configurables : Métrique / Impérial.
- Alarmes visuelles et sonores.
- Instrument de diagnostic intégré.
- Paramètres gérés : pression, vitesse, débit, superficie traitée, quantité distribuée, durée du traitement, distance parcourue et niveau citerne.



Part No.	Section Valves (W)	Description	Pack
8410031	2	GeoSystem 220 2W OS	1
8410032	4	GeoSystem 220 4W OS	1

FEATURES

Display Dimension 123 x 30.4 mm	Display Type Alphanumeric 16x2 Monochromatic	Display Light Green Backlight
Language IT-EN-ES FR-DE-PT RU-PL-FI	kg ~1	°C -20 +70
	V dc 9.5 - 32	A < 0,5
	Protection IP 67	case PA66 GF 30

DIMENSIONS

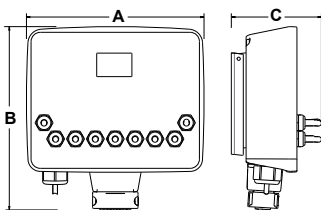

AxBxC mm
192x198x96,5

Campo di impiego / Use / Utilisation



Composizione del kit / Kit composed of / Composition du kit

SPARE PARTS Pag. 50-51

A Monitor Monitor Monitor		K Sensore di velocità Speed sensor Capteur de vitesse	L = 5,0 m
M Prolunga per cavo collegamento valvole + sensore Extension for valves + sensor connecting cable Rallonge pour câble de branchement vannes + capteur	M-F 24P L = 5,0 m	L Staffa di fissaggio Mounting bracket Bride de fixation	
N Collegamento valvole + sensore Valves + sensor connecting cable Câble de branchement vannes + capteur	4Sens. L = 1,2 m		



A

L = 5,0 m



M

L = 1,2 m



N

L = 5,0 m





K

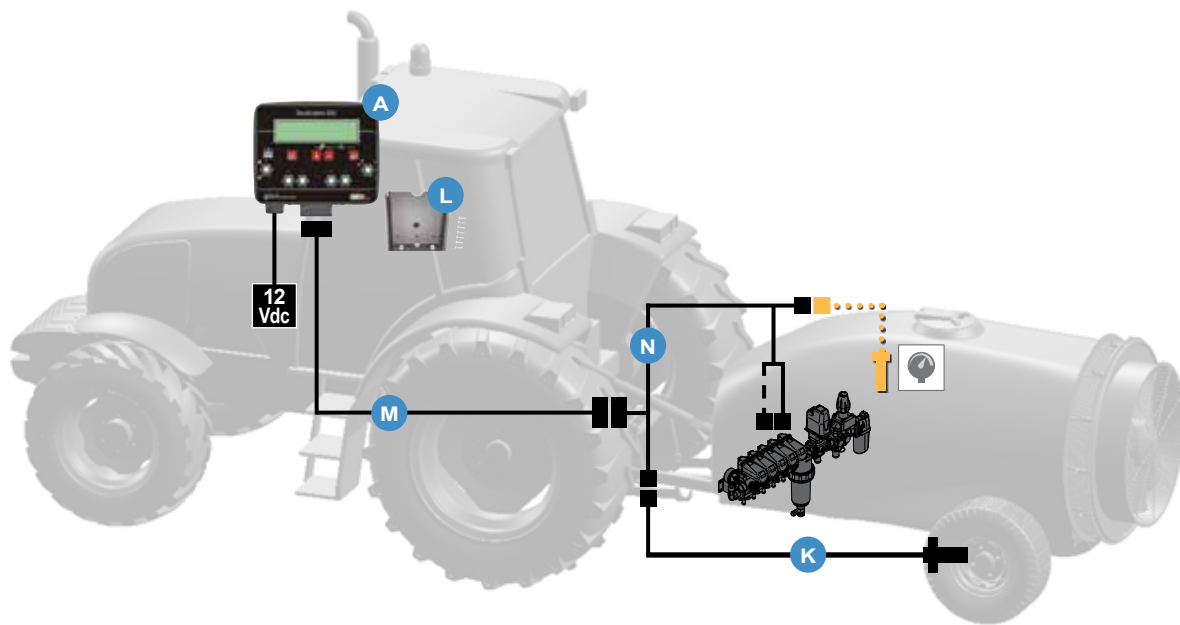

L



OPTIONALS

PAGE		PAGE	
111-114	Flussometro Flowmeter Débitmètre		
112	Sensore di flusso Flow sensor Capteur de débi		
51	Cavo adattatore flussometro Flow meter adapter cable Câble adaptateur débitmètre	L = 0,5 m	
42	Sensore di pressione Pressure sensor Capteur de pression	 20 bar 4-20 mA L = 5,0 m	43 Cavo adattatore sensore di livello Level sensor adapter cable Câble adaptateur capteur de niveau L = 0,5 m
42	Sensore di pressione Pressure sensor Capteur de pression	 50 bar 4-20 mA L = 5,0 m	45 Prolunga per cavo collegamento valvole + sensore Extension for valves + sensor connecting cable Rallonge pour câble de branchement vannes + capteur M-F 24P L = 5,0 m
42	Sensore di pressione Pressure sensor Capteur de pression	 100 bar 4-20 mA L = 5,0 m	45 Prolunga per cavo collegamento valvole + sensore Extension for valves + sensor connecting cable Rallonge pour câble de branchement vannes + capteur M-F 24P L = 7,0 m
42	Cavo adattatore sensore di pressione Pressure sensor adapter cable Câble adaptateur capteur de pression	L = 0,5 m	47 Staffa ventosa con sfera + Supporto a sfera per fissaggio monitor Suction cup bracket with ball + Monitor holder with ball Bride ventouse à bille + Support à bille pour fixation moniteur
42	Sensore di livello completo di supporto per fissaggio Level sensor complete with mounting bracket Capteur de niveau avec support de fixation	L = 0,5 m	47 Staffa da palo con sfera (senza braccio di completamento) Pole bracket with ball (without supplementary arm) Bride de montant à bille (sans bras complémentaire)
43	Cavo collegamento Sensore di livello - Driver Box Level sensor-Driver Box connecting cable Câble de branchement capteur de niveau - Driver Box	L = 5,0 m	48 Staffa da palo + Braccio + Supporto a sfera per fissaggio monitor Pole bracket + Arm + Monitor holder with ball Bride de montant + Bras + Support à bille pour fixation moniteur
			48 Braccio + Supporto a sfera per fissaggio monitor Arm + Monitor holder with ball Bras + Support à bille pour fixation moniteur
			48 Supporto a sfera per fissaggio monitor Monitor holder with ball Support à bille pour fixation moniteur

GeoSystem 210

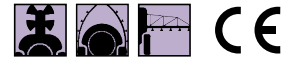

Visualizzatore per distribuzione di prodotti fito-sanitari, adatto per macchine da diserbo, atomizzatori e multi-filari.

Display for distributing plant protection products, suitable for use on weed-killing machines, sprayers and multi-row machines.

Écran pour distribution de produits phytosanitaires, adapté aux machines de désherbage, atomiseurs et multifilaires.

Caratteristiche:

- Versioni: fino a 7 valvole di sezione.
- Funzionamento manuale.
- Scatola di derivazione (Driver Box) a cablaggio semplificato di rapida installazione.
- Display LCD retroilluminato, leggibile in ogni condizione di luce.
- Menu multilingua
- Unità di misura configurabili: Metrico / US.
- Allarmi visivi e sonori
- Strumento di diagnostica integrato
- Parametri visualizzati: pressione.

Features:

- Versions: up to 7 section valves.
- Manual operation.
- Connecting box (Driver Box) with simplified, quick-to-install wiring.
- Backlit LCD display, legible in all lighting conditions.
- Multilingual menu
- Configurable units of measurement: Metric/US
- Visual and audible alarms
- Integrated diagnostic tool
- Parameters displayed: pressure.

Caractéristiques :

- Versions : jusqu'à 7 vanes de section.
- Fonctionnement automatique et manuel.
- Boîtier de dérivation (Driver Box) à câblage simplifié rapide à installer.
- Écran LCD à rétro-éclairage, lisible dans toute condition de luminosité.
- Menu multilingue.
- Unités de mesure configurables : Métrique / Impérial.
- Alarmes visuelles et sonores.
- Instrument de diagnostic intégré.
- Paramètres gérées : pression.

Ordinare il sensore di pressione separatamente.

Order pressure sensor separately.

Commander le capteur de pression séparément.



Part No.	Section Valves (W)	Volumetric Valve	Main Valve	Description	Pack
8406059	2	1	1 (RI)	Kit GeoSystem 210 2W+V+M (RI)	1
8406060	3	1	1 (RI)	Kit GeoSystem 210 3W+V+M (RI)	1
8406061	5	1	1 (RI)	Kit GeoSystem 210 5W+V+M (RI)	1
8406062	7	1	1 (RI)	Kit GeoSystem 210 7W+V+M (RI)	1
8406063	2	1	1 (RD)	Kit GeoSystem 210 2W+V+M (RD)	1
8406064	3	1	1 (RD)	Kit GeoSystem 210 3W+V+M (RD)	1
8406065	5	1	1 (RD)	Kit GeoSystem 210 5W+V+M (RD)	1
8406066	7	1	1 (RD)	Kit GeoSystem 210 7W+V+M (RD)	1

DIMENSIONS

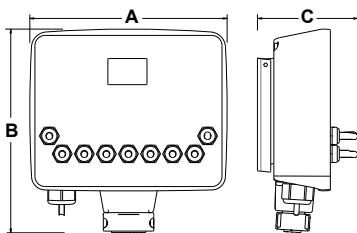

AxBxC mm
192x198x96,5

FEATURES

Display Dimension 36 x 22,5 mm	Display Resolution 128x64 pixel	Display Type FSTN Graphical Monochromatic	Display Light White LED Backlight
Language IT-EN-ES FR-DE-PT	kg ~1	°C -20 +70	V dc 9.5 - 32
	A < 0,5	Protection IP 67	case PA66 GF 30

Campo di impiego / Use / Utilisation



Composizione del kit / Kit composed of / Composition du kit

SPARE PARTS Pag. 50-51



<p>A Monitor Monitor Monitor</p>	<p>M Prolunga per cavo collegamento valvole + sensore Extension for valves + sensor connecting cable Rallonge pour câble de branchement vannes + capteur</p> <p>M-F 24P L = 3,0 m</p>	<p>N Collegamento valvole + sensore Valves + sensor connecting cable Câble de branchement vannes + capteur</p> <p>input 1 sens. L = 1,2 m</p>
 A	 M	 N
	 L	

INSTALLATION

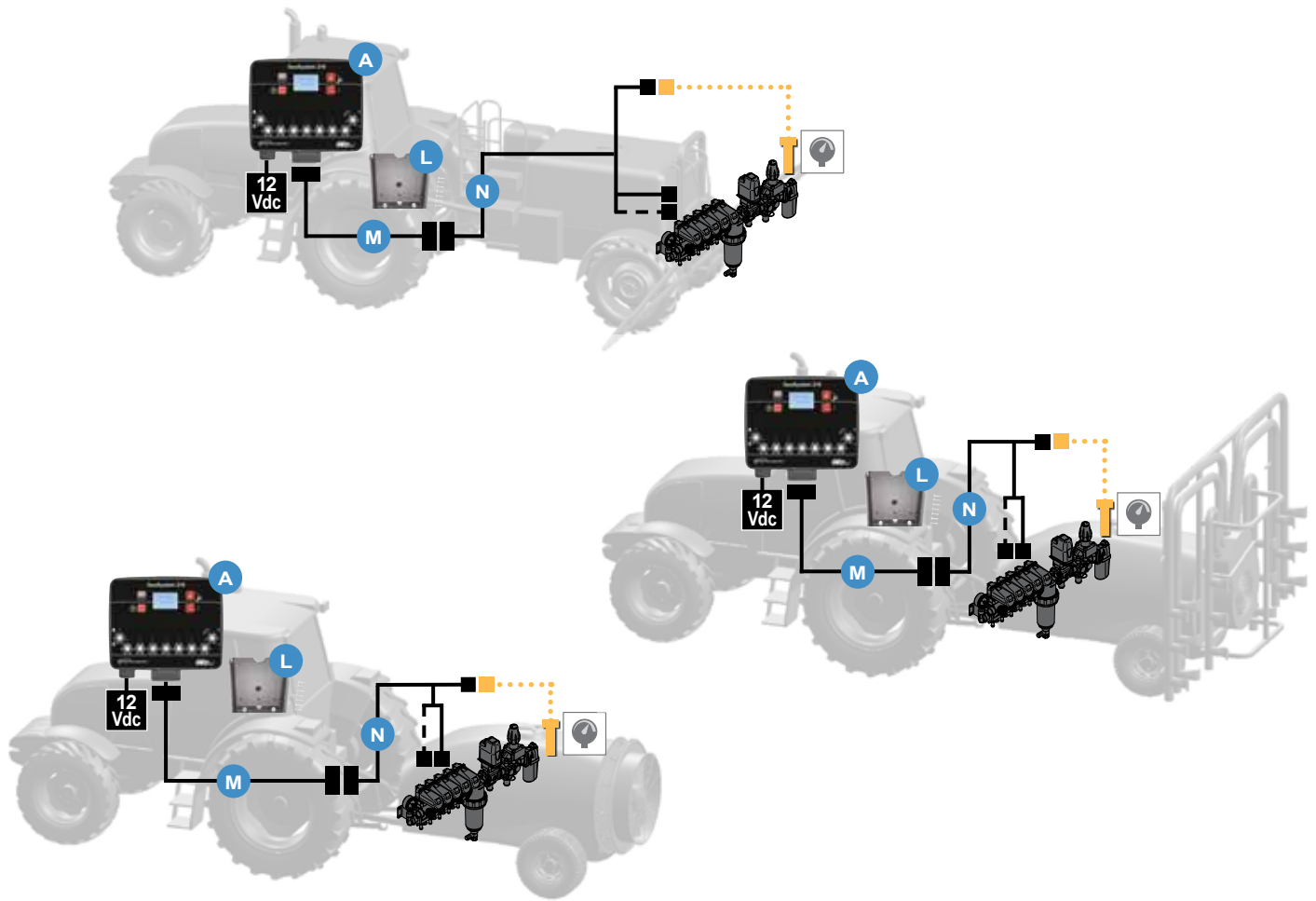
GS 210



OPTIONALS

PAGE			PAGE		
42	Sensore di pressione Pressure sensor Capteur de pression		20 bar 4-20 mA L = 5,0 m	47	Staffa ventosa con sfera + Supporto a sfera per fissaggio monitor Suction cup bracket with ball + Monitor holder with ball Bride ventouse à bille + Support à bille pour fixation moniteur
42	Sensore di pressione Pressure sensor Capteur de pression		50 bar 4-20 mA L = 5,0 m	47	Staffa da palo con sfera (senza braccio di completamento) Pole bracket with ball (without supplementary arm) Bride de montant à bille (sans bras complémentaire)
42	Sensore di pressione Pressure sensor Capteur de pression		100 bar 4-20 mA L = 5,0 m	48	Staffa da palo + Braccio + Supporto a sfera per fissaggio monitor Pole bracket + Arm + Monitor holder with ball Bride de montant + Bras + Support à bille pour fixation moniteur
42	Cavo adattatore sensore di pressione Pressure sensor adapter cable Câble adaptateur capteur de pression		L = 0,5 m	48	Braccio + Supporto a sfera per fissaggio monitor Arm + Monitor holder with ball Bras + Support à bille pour fixation moniteur
45	Prolunga per cavo collegamento valvole + sensore Extension for valves + sensor connecting cable Rallonge pour câble de branchement vannes + capteur		M-F 24P L = 5,0 m	48	Supporto a sfera per fissaggio monitor Monitor holder with ball Support à bille pour fixation moniteur
45	Prolunga per cavo collegamento valvole + sensore Extension for valves + sensor connecting cable Rallonge pour câble de branchement vannes + capteur		M-F 24P L = 7,0 m		

GeoRemote



Sistema per il controllo wireless di gruppi di comando con valvole motorizzate.

Control units with motorized valves' wireless system.

Système de contrôle sans fil de groupes de commande à valves motorisées.

Caratteristiche:

- Un'unica applicazione Android scaricabile sul tuo smartphone (o tablet);
- Gestisce le valvole tramite DriverBox;
- Il controllo delle valvole viene effettuato tramite sistema Wi-Fi direct;
- L'unico collegamento necessario è il cavo di alimentazione della DriverBox;
- Lettura istantanea della pressione di lavoro;
- Segnalazione dello sfioramento del range di pressione impostato;
- Spia di stato valvola ON-OFF.

Features:

- One Android app for smartphone and tablets;
- Valves management through DriverBox;
- Valves full control through Wi-fi direct connection;
- Power supply cable in the Driver Box;
- Instantaneous operating pressure reading;
- Alarm on pressure range overruns;
- ON-OFF valve indicator light.

Caractéristiques :

- Une unique application Android téléchargeable sur smartphone (ou tablette);
- Gestion des valves via DriverBox;
- Le contrôle des valves est assuré à travers le système Wi-Fi direct;
- Le seul branchement nécessaire est celui du câble d'alimentation de la DriverBox;
- Lecture instantanée de la pression de service;
- Signal de dépassement de la limite de pression programmée;
- Voyant d'état valve ON-OFF.



Part No.	Name	Description	Section Valves (W)	Main Valves	Proportional Valves	Foam Marker
8407017	Atom 1	Kit WI Atom 1	2	1	1	-
8407018	Atom 2	Kit WI Atom 2	4	1	1	-
8407019	Crop 3	Kit WI Crop 3	3	1	1	✓
8407020	Crop 5	Kit WI Crop 5	5	1	1	✓
8407021	Crop 7	Kit WI Crop 7	7	1	1	✓

kg	°C	V dc	Protection	case
~1	-20 +70	12	IP 67	PA66 GF 30

INSTALLATION

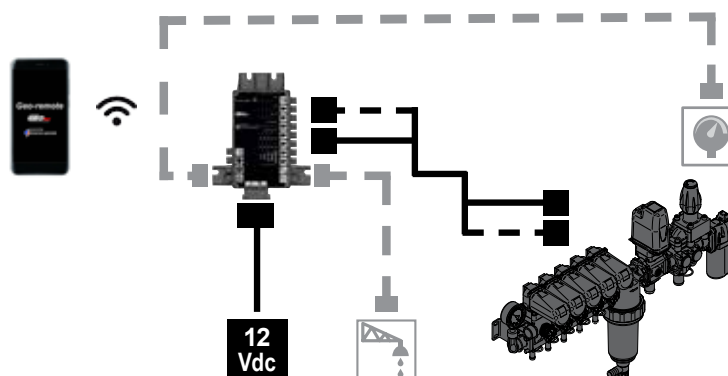

OPTIONALS

PAGE

51	Cavo collegamento tracciale Foam marker connecting cable Câble de branchement traceur de files	L = 0,4 m
42	Sensore di pressione Pressure sensor Capteur de pression	20 bar 4-20 mA L = 5,0 m
42	Sensore di pressione Pressure sensor Capteur de pression	50 bar 4-20 mA L = 5,0 m
42	Sensore di pressione Pressure sensor Capteur de pression	100 bar 4-20 mA L = 5,0 m

KIT WI CROP 7 WORKING SCREEN

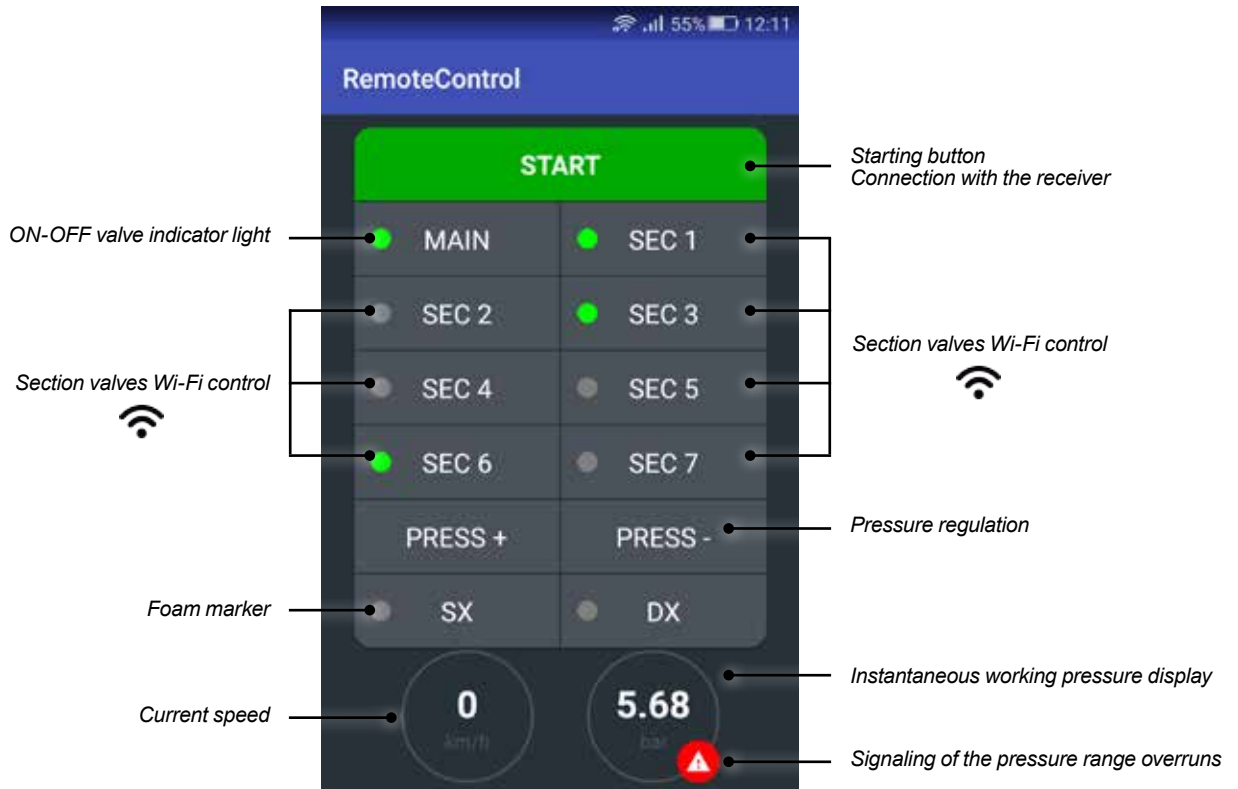

REMOTE CONTROL LAYOUT SCREEN

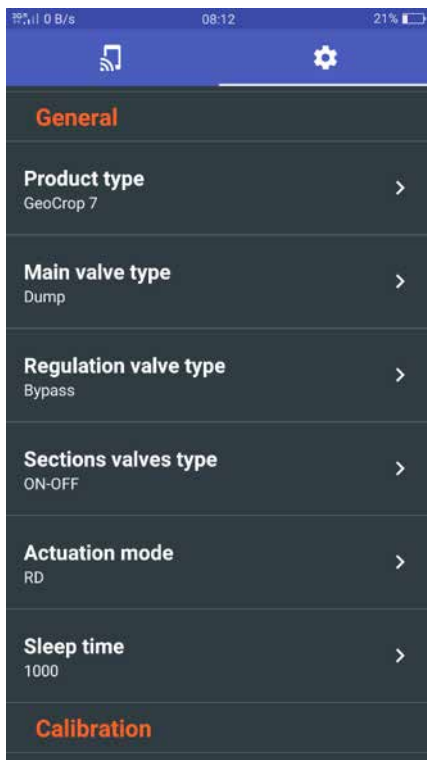

SENSOR LAYOUT SCREEN

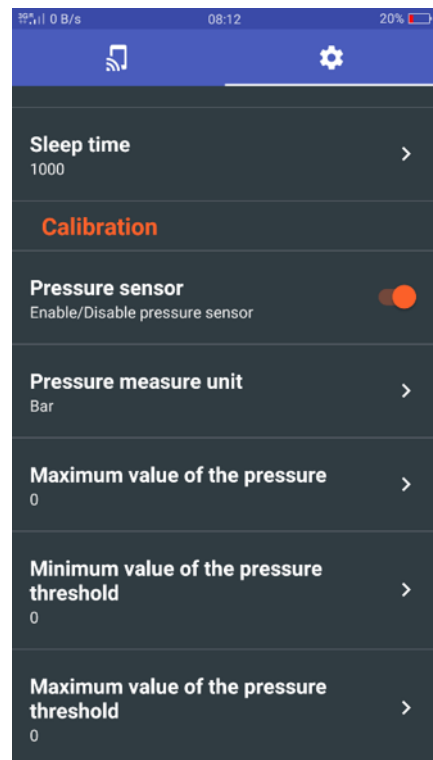

GeoSystem 200

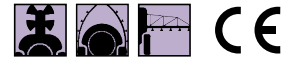

Caratteristiche:

- Installazione e collegamento semplici e veloci;
- Dimensioni ridotte e di facile installazione;
- Display LCD retroilluminato di grandi dimensioni, leggibile in ogni condizione di luce;
- Menu multilingua;
- Inserimento semplificato dei parametri di lavoro;
- Unità di misura configurabili: Metrico / US;
- Allarmi visivi e sonori;
- Strumento di diagnostica integrato.

- Funzione di stop automatico programmabile, durante il riempimento (stop pompa). Questa funzione è programmabile solo acquistando separatamente l'apposito cavo.

Features:

- Easy and quick installation and connection;
- Compact and easy to install;
- Large, backlit LCD display, legible in all lighting conditions;
- Multilingual menu;
- Simplified work parameter entry;
- Configurable units of measurement: Metric/US;
- Visual and audible alarms;
- Integrated diagnostic tool.

- Self-stop automatic settable function while refilling (pump stop). This function is settable only by purchasing the cable separately.

Caractéristiques:

- Mise en place et connexion rapides et faciles
- Dimensions réduites et facilité d'installation;
- Écran LCD à rétro-éclairage, lisible en toutes conditions de luminosité;
- Menu multilingue;
- Saisie simplifiée des paramètres de travail;
- Unités de mesure configurables : métrique/U.S. ;
- Alarmes visuelles et sonores;
- Instrument de diagnostic intégré.

- Fonctionne d'arrêt automatique programmable pendant le remplissage (arrêt de pompe). Cette fonction est programmable en achetant séparément le câble correspondant.



FEATURES

Display Dimension	Display Type	Display Light
123 x 30.4 mm	Alphanumeric 16x2 Monochromatic	Green Backlight
Language	kg	°C
IT-EN-ES FR-DE-PT RU-PL-FI	~1	-20 +70
	V dc	A
	9.5 - 32	< 0,5
	Protection	case
	IP 67	PA66 GF 30

DIMENSIONS

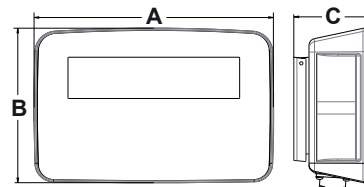

AxBxC mm
173x12,6x9x59,2

GeoSystem 200 - Level display

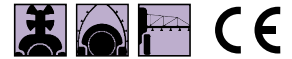

Visualizzatore adatto per macchine da diserbo, atomizzatori e multi-filari.

Display suitable for use on weed-killing machines, sprayers and multi-row machines.

Écran de visualisation adapté aux machines de désherbage, atomiseurs et multifilaires.

Consente di visualizzare il livello in cisterna.

Tank level displayed.

Affichage du niveau dans le réservoir.



Part No.	Description	Pack
8408006	GeoSystem 200 - Level display	1

Composizione del kit / Kit composed of / Composition du kit

A	Monitor Monitor Monitor	
B	Cavo collegamento GS 200 - Sensore di livello GS 200 - Level sensor connecting cable Câble de branchement GS 200 - Capteur de niveau	L = 5,0 m
C	Sensore di livello completo di supporto per fissaggio Level sensor complete with mounting bracket Capteur de niveau avec support de fixation	
L	Staffa di fissaggio Mounting bracket Bride de fixation	

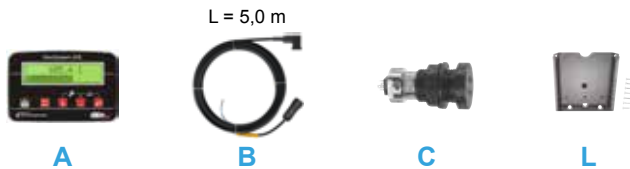

SPARE PARTS Pag. 50-51

INSTALLATION

GS 200

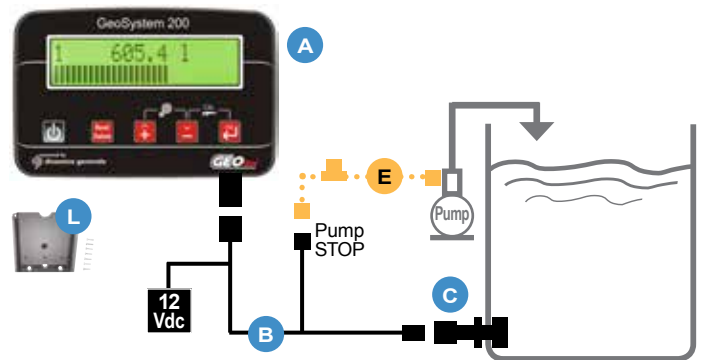

OPTIONALS

PAGE

49	Kit collegamento tracciafile + stop pompa GS200 Foam marker connecting kit + pump stop GS200 Kit de connexion du traceur + arrêt de pompe GS200	E
-----------	---	----------

GeoSystem 200 - Rate display



Visualizzatore adatto per macchine da diserbo, atomizzatori e multi-filari.

Display suitable for use on weed-killing machines, sprayers and multi-row machines.

Écran de visualisation adapté aux machines de désherbage, atomiseurs et multifilaires.

Consente di visualizzare

- misura istantanea della dose distribuita;
- superficie lavorata;
- velocità e flusso;
- tempo di lavoro.

Parameters managed:

- simultaneous flow rate measure;
- treated area;
- speed and flow;
- working time.

Affichage de:

- mesure directe de la dose distribuée;
- murface ouvrée;
- vitesse et débit;
- temps de travail.



Part No.	Description	Pack
8408005	GeoSystem 200 - Rate display	1

Composizione del kit / Kit composed of / Composition du kit

A	Monitor Monitor Monitor	
O	Cavo Alimentazione 2 sensori D+D 2 sensors D+D feeding cable Câble d'alimentation 2 sensori D+D	L = 2,0 m
P	Sensore di velocità Speed sensor Capteur de vitesse	L = 5,0 m
Q	Flussometro ispezionabile con turbina e flange 1" Inspectable flowmeter with turbine and 1" flanges Débitmètre pouvant être inspecté, avec turbine et brides 1"	L = 2,0 m
L	Staffa di fissaggio Mounting bracket Bride de fixation	



SPARE PARTS Pag. 50-51

INSTALLATION

GS 200

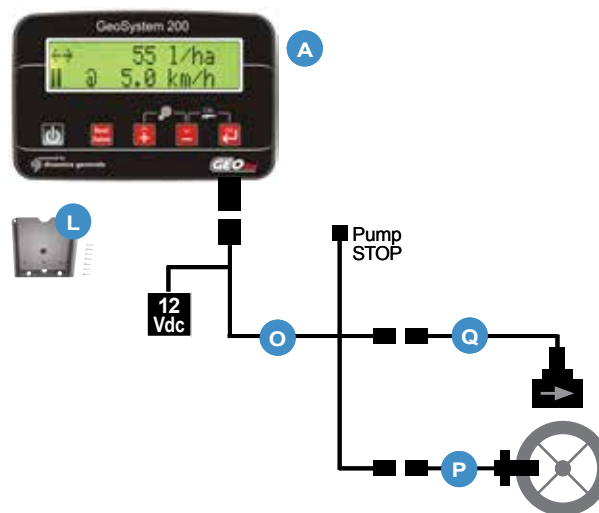

OPTIONALS

PAGE		PAGE	
48	Staffa ventosa con sfera Suction cup bracket with ball Bride ventouse à bille	108	Flange di accoppiamento Adapters Brides d'assemblage
48	Staffa da palo + Braccio + Supporto a sfera per fissaggio monitor Pole bracket + Arm + Monitor holder with ball Bride de montent + Bras + Support à bille pour fixation moniteur	109	Kit di assemblaggio Assembling kit Kit d'assemblage
49	Kit collegamento tracciabile + stop pompa GS200 Foam marker connecting kit + pump stop GS200 Kit de connexion du traceur + arrêt de pompe GS200		

GeoSystem 200 - RPM display



Visualizzatore adatto per macchine da diserbo, atomizzatori e multi-filari.

Display suitable for use on weed-killing machines, sprayers and multi-row machines.

Écran de visualisation adapté aux machines de désherbage, atomiseurs et multifilaires.

Consente di visualizzare:

- misura velocità di organo in rotazione;
- misura pressione o livello cisterna.

Parameters managed:

- rotating speed measure;
- pressure or tank level measure.

Affichage de:

- mesure de vitesse de rotation;
- mesure de pression ou niveau du réservoir.



Part No.	Description	Pack
8408007	GeoSystem 200 - RPM display	1

Composizione del kit / Kit composed of / Composition du kit

A	Monitor Monitor Monitor	
O	Cavo Alimentazione 2 sensori A+D 2 sensors A+D feeding cable Câble d'alimentation 2 sensori A+D	L = 2,0 m
P	Sensore di velocità Speed sensor Capteur de vitesse	L = 5,0 m
L	Staffa di fissaggio Mounting bracket Bride de fixation	



SPARE PARTS Pag. 50-51

INSTALLATION

GS 200

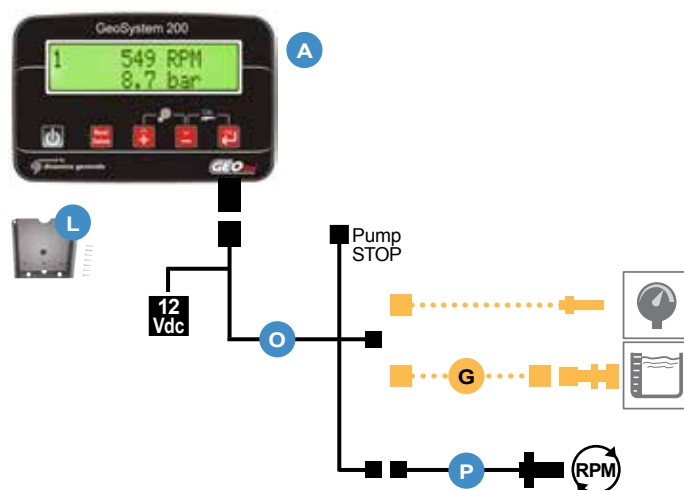

OPTIONALS

PAGE		PAGE	
42	Sensore di pressione Pressure sensor Capteur de pression	42	Cavo collegamento Sensore di livello GS 200 Level sensor connecting cable GS 200 Câble de branchement capteur de niveau GS 200
42	Sensore di pressione Pressure sensor Capteur de pression	43	Cavo adattatore sensore di livello Level sensor adapter cable Câble adaptateur capteur de niveau
42	Sensore di pressione Pressure sensor Capteur de pression	48	Staffa ventosa con sfera Suction cup bracket with ball Bride ventouse à bille
42	Cavo adattatore sensore di pressione Pressure sensor adapter cable Câble adaptateur capteur de pression	48	Staffa da palo + Braccio + Supporto a sfera per fissaggio monitor Pole bracket + Arm + Monitor holder with ball Bride de montant + Bras + Support à bille pour fixation moniteur
42	Sensore di livello completo di supporto per fissaggio Level sensor complete with mounting bracket Capteur de niveau avec support de fixation	49	Kit collegamento tracciafile + stop pompa GS200 Foam marker connecting kit + pump stop GS200 Kit de connexion du traceur + arrêt de pompe GS200

Compact 10 W



Scatole di comando compatte dotate di fissaggio orientabile, led di controllo e fusibile generale di protezione. Offrono una soluzione affidabile e conveniente laddove sono necessari ingombri ridotti.

Compact control boxes with adjustable mounting system, working led and main safety fuse. A reliable and convenient solution where a compact size box is needed.

Boîtiers de commande avec support orientable, led de travail et fusible général de protection. Une solution fiable, avantageuse et peu encombrante.

Adatte per il comando di valvole di sezione.

Suitable for controlling section valves.

Adaptés pour la commande de vannes de section.

***RI:** con valvole di sezione indipendenti.

***RI:** with independent section valves.

***RI:** avec vannes de section indépendantes.

Campo di impiego Use / Utilisation

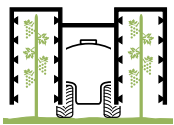

Part No.	Type	Section Valves	Volumetric Valve	Main Valve	C1	C2	Pack
		V	P	G	L (m)	L (m)	

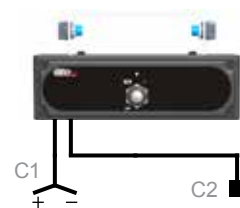

8406067	Compact 10 W 1V *RI	1	-	-	2,0	4,0	1
---------	-------------------------------	---	---	---	-----	-----	---

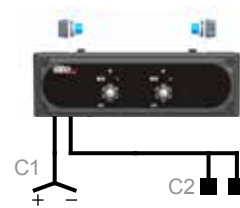

8406068	Compact 10 W 2V *RI	2	-	-	2,0	4,0	1
---------	-------------------------------	---	---	---	-----	-----	---

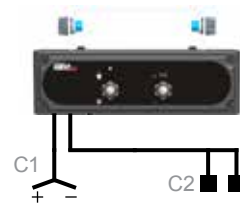

8406069	Compact 10 W P+G *RI	-	1	1	2,0	4,0	1
---------	--------------------------------	---	---	---	-----	-----	---

FEATURES

kg	°C	V dc
~1	60	12

INSTALLATION

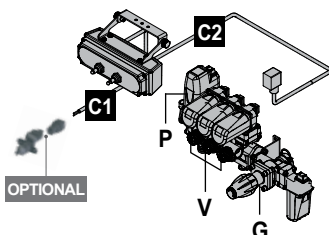

Compact 10 W



Scatole di comando compatte dotate di fissaggio orientabile, led di controllo e fusibile generale di protezione. Offrono una soluzione affidabile e conveniente laddove sono necessari ingombri ridotti.

Compact control boxes with adjustable mounting system, working led and main safety fuse. A reliable and convenient solution where a compact size box is needed.

Boîtiers de commande avec support orientable, led de travail et fusible général de protection. Une solution fiable, avantageuse et peu encombrante.

Adatte per il comando di valvole di sezione.

Suitable for controlling section valves.

Adaptés pour la commande de vannes de section.

***RI:** con valvole di sezione indipendenti.

***RI:** with independent section valves.

***RI:** avec vannes de section indépendantes.

****RD:** dove la valvola generale in OFF chiude automaticamente tutte le valvole di sezione..

****RD:** with section valves controlled by the main valve.

****RD:** où la vanne générale en OFF serre toutes les sections.

Campo di impiego Use / Utilisation



FEATURES

kg °C V dc
~1 60 12

INSTALLATION

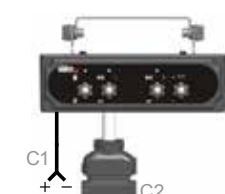
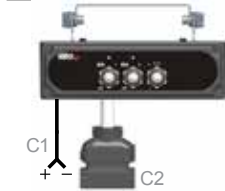
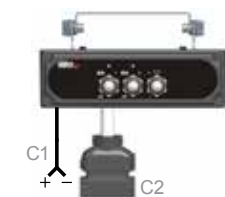
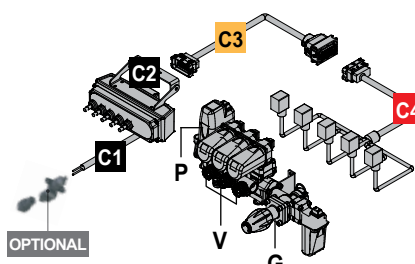

Part No.	Type	Section Valves	Volumetric Valve	Main Valve	C1 L (m)	C2 L (m)	Pack
		V	P	G			
8406070	Compact 10 W 2V+P *RI	2	1	-	2,0	0,3	1
8406077	Compact 10 W 3V *RI	3	-	-	2,0	0,3	1
8406071	Compact 10 W 2V+P+G *RI	2	1	1	2,0	0,3	1
8406079	Compact 10 W 2V+P+G **RD	2	1	1	2,0	0,3	1
8406072	Compact 10 W 4V+P+G *RI	4	1	1	2,0	0,3	1
8406080	Compact 10 W 4V+P+G **RD	4	1	1	2,0	0,3	1
8406073	Compact 10 W 7V+P+G *RI	7	1	1	2,0	0,3	1

OPTIONALS

COMPACT 10 W Part No.	C3 - EXTENSION CABLE		
	L = 3,0 m Part No.	L = 5,0 m Part No.	L = 7,0 m Part No.
8406070	> C00902014	> C00902015	> C00902030
8406071	> C00902014	> C00902015	> C00902030
8406079	> C00902014	> C00902015	> C00902030
8406077	> C00902014	> C00902015	> C00902030
8406072	> C00902014	> C00902015	> C00902030
8406080	> C00902014	> C00902015	> C00902030
8406073	> C00902016	> C00902017	> C00902030

Pag. 45



C4 - END CABLE

L = 3,0 m Part No.	L = 5,0 m Part No.
> C00902008	> C00902011
> C00902008	> C00902011
> C00902158	> C00902159
> C00902009	> C00902012
> C00902009	> C00902012
> C00902010	> C00902013

Pag. 41



Obbligatorio ordinare il cavo C4 separatamente.
Compulsory: cable C4 to be ordered separately.
Obligatoire: commander le câble C4 séparément.

Compact 15 H



Scatole di comando compatte dotate di fissaggio orientabile, led di controllo e fusibile generale di protezione. Offrono una soluzione affidabile e conveniente laddove sono necessari ingombri ridotti.

Compact control boxes with adjustable mounting system, working led and main safety fuse. A reliable and convenient solution where a compact size box is needed.

Boîtiers de commande avec support orientable, led de travail et fusible général de protection. Une solution fiable, avantageuse et peu encombrante.

Adatte per il comando di valvole movimenti idraulici.

Suitable for controlling hydraulic control valves.

Adaptés pour la commande de vannes à commandes hydrauliques.

Campo di impiego Use / Utilisation

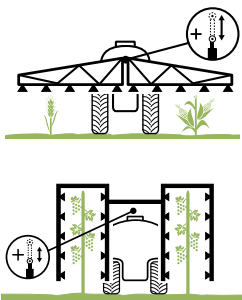

Part No.	Type	Hydraulic Valves H	Foamer	Switch ON Off	C1 L (m)	C2 L (m)	Pack
----------	------	-----------------------	--------	---------------------	-------------	-------------	------

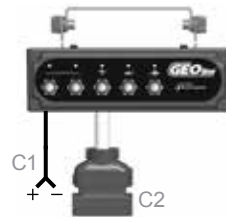

8406054	Compact 15 H 3+2	3+2	-	-	2,0	0,3	1
----------------	------------------------	-----	---	---	-----	-----	---

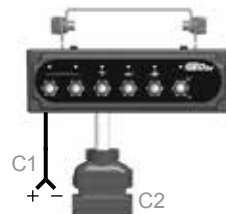

8406083	Compact 15 H 3+2	3+2	-	✓	2,0	0,3	1
----------------	------------------------	-----	---	---	-----	-----	---

FEATURES

kg	°C	V dc
~1	60	12

INSTALLATION

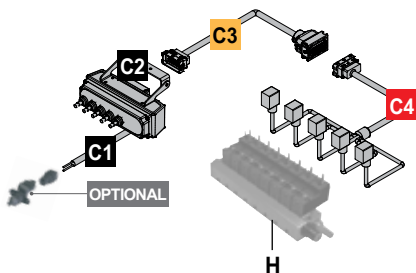

OPTIONALS

COMPACT 15 H Part No.	C3 - EXTENSION CABLE
8406054	L = 5,0 m Part No. C00902045
8406083	L = 5,0 m Part No. C00902045

Pag. 46



Obbligatorio ordinare il cavo C4 separatamente.
Compulsory: cable C4 to be ordered separately.
Obligatoire: commander le câble C4 séparément.

C4 - END CABLE	
L = 3,0 m Part No. C00902039	L = 5,0 m Part No. C00902042
L = 3,0 m Part No. C00902039	L = 5,0 m Part No. C00902042

Pag. 41



Compact 15 H



Scatole di comando compatte dotate di fissaggio orientabile, led di controllo e fusibile generale di protezione. Offrono una soluzione affidabile e conveniente laddove sono necessari ingombri ridotti.

Compact control boxes with adjustable mounting system, working led and main safety fuse. A reliable and convenient solution where a compact size box is needed.

Boîtiers de commande avec support orientable, led de travail et fusible général de protection. Une solution fiable, avantageuse et peu encombrante.

Adatte per il comando di valvole movimenti idraulici.

Suitable for controlling hydraulic control valves.

Adaptés pour la commande de vannes à commandes hydrauliques.

Campo di impiego Use / Utilisation



Part No.	Type	Hydraulic Valves H	Foamer	Switch ON/Off	C1 L (m)	C2 L (m)	Pack
----------	------	-----------------------	--------	---------------	----------	----------	------

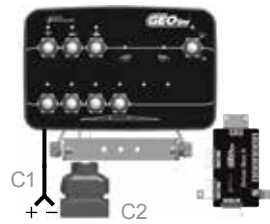

8406055	Compact 15 H 3+4	3+4	-	✓	2,0	0,3	1
---------	------------------	-----	---	---	-----	-----	---

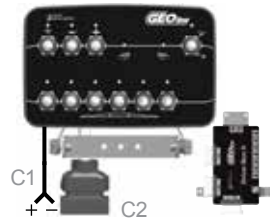

8406056	Compact 15 H 3+6	3+6	-	✓	2,0	0,3	1
---------	------------------	-----	---	---	-----	-----	---

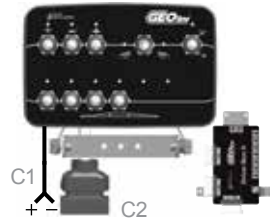

8406057	Compact 15 H 3+4 +Foamer	3+4	1	✓	2,0	0,3	1
---------	--------------------------	-----	---	---	-----	-----	---

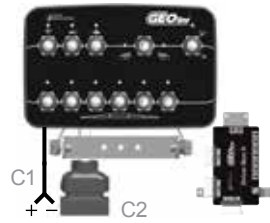

8406058	Compact 15 H 3+6 +Foamer	3+6	1	✓	2,0	0,3	1
---------	--------------------------	-----	---	---	-----	-----	---

FEATURES

kg	°C	V dc
~1	60	12

INSTALLATION

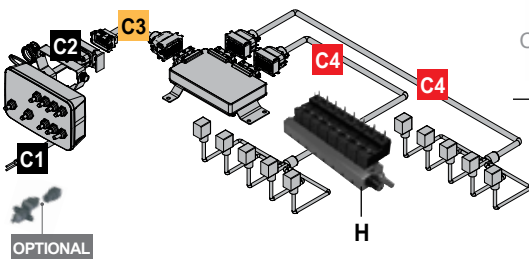

OPTIONALS

COMPACT 15 H Part No.
8406055
8406056
8406057
8406058

C3 - EXTENSION CABLE
L = 5,0 m Part No.
> C00902045
> C00902045
> C00902045
> C00902045

Pag. 46



Obbligatorio ordinare il cavo C4 separatamente.
Compulsory: cable C4 to be ordered separately.
Obligatoire: commander le câble C4 séparément.

C4 - END CABLE	
L = 3,0 m Part No.	L = 5,0 m Part No.
> C00902053 + C00902040	> C00902054 + C00902043
> C00902053 + C00902041	> C00902054 + C00902044
> C00902053 + C00902040	> C00902054 + C00902043
> C00902053 + C00902041	> C00902054 + C00902044

Pag. 41



Compact 20 W-SOL



Scatole di comando compatte dotate di fissaggio orientabile, led di controllo e fusibile generale di protezione. Offrono una soluzione affidabile e conveniente laddove sono necessari ingombri ridotti.

Compact control boxes with adjustable mounting system, working led and main safety fuse. A reliable and convenient solution where a compact size box is needed.

Boîtiers de commande avec support orientable, led de travail et fusible général de protection. Une solution fiable, avantageuse et peu encombrante.

Adatte per il comando di valvole di sezione a solenoide.

Suitable for controlling section valves with solenoid.

Adaptés pour la commande d'électrovannes de section.

*RI: con valvole di sezione indipendenti.

*RI: with independent section valves.

*RI: avec vannes de section indépendantes.

**RD: dove la valvola generale in OFF chiude automaticamente tutte le valvole di sezione..

**RD: with section valves controlled by the main valve.

**RD: où la vanne générale en OFF serre toutes les sections.

Campo di impiego Use / Utilisation



Part No.	Type	Section Valves V	Volumetric Valve P	Main Valve G	C1 L (m)	C2 L (m)	Pack
----------	------	---------------------	-----------------------	-----------------	-------------	-------------	------

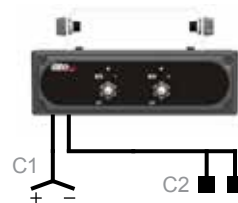

8406074	Compact 20 W-SOL 2V *RI	2	-	-	2,0	4,0	1
---------	-----------------------------------	---	---	---	-----	-----	---

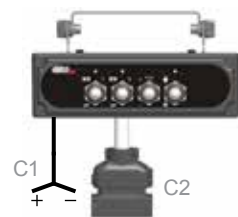

8406075	Compact 20 W-SOL 2V+P+G *RI	2	1	1	2,0	0,3	1
---------	---------------------------------------	---	---	---	-----	-----	---



8406081	Compact 20 W-SOL 2V+P+G **RD	2	1	1	2,0	0,3	1
---------	--	---	---	---	-----	-----	---

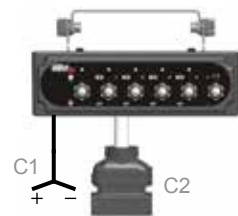

8406076	Compact 20 W-SOL 4V+P+G *RI	4	1	1	2,0	0,3	1
---------	---------------------------------------	---	---	---	-----	-----	---



8406082	Compact 20 W-SOL 4V+P+G **RD	4	1	1	2,0	0,3	1
---------	--	---	---	---	-----	-----	---

FEATURES

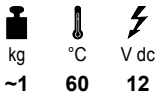

INSTALLATION

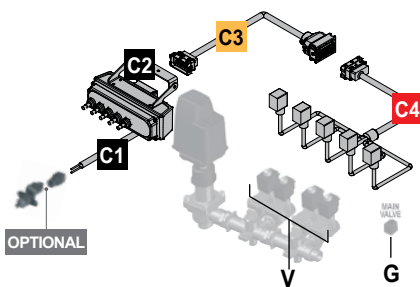

OPTIONALS

COMPACT 20 W-SOL Part No.	C3 - EXTENSION CABLE		
	L = 3,0 m Part No.	L = 5,0 m Part No.	L = 7,0 m Part No.
8406074	> C00902014	C00902015	C00902030
8406075	> C00902014	C00902015	C00902030
8406081	> C00902014	C00902015	C00902030
8406076	> C00902014	C00902015	C00902030
8406082	> C00902014	C00902015	C00902030

Pag. 45



Obbligatorio ordinare il cavo C4 separatamente.
Compulsory: cable C4 to be ordered separately.
Obligatoire: commander le câble C4 séparément.

C4 - END CABLE

L = 3,0 m Part No.	L = 5,0 m Part No.
-	-
> C00902018	C00902020
> C00902018	C00902020
> C00902019	C00902021
> C00902019	C00902021

Pag. 41





END CABLES

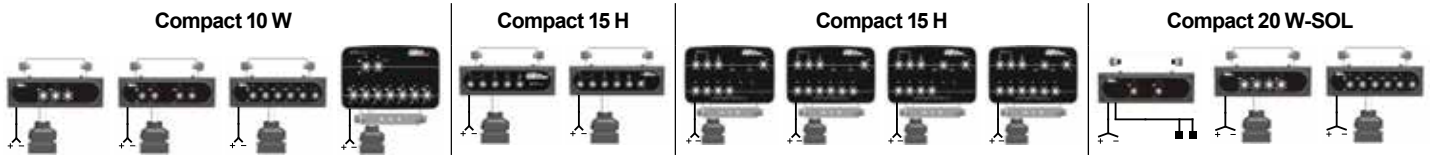

Part No.	Type	Suitable for	Pack	
C00902008 C4	Cavo collegamento: Compact 10 W - Valvole di sezione <i>Connecting cable: Compact 10 W - Section valves</i> <i>Câble de branchement: Compact 10 W - Vannes de section</i>	2V+P+G L = 3,0 m	COMPACT 10 W	1
C00902158 C4	Cavo collegamento: Compact 10 W - Valvole di sezione <i>Connecting cable: Compact 10 W - Section valves</i> <i>Câble de branchement: Compact 10 W - Vannes de section</i>	3V L = 3,0 m	COMPACT 10 W	1
C00902009 C4	Cavo collegamento: Compact 10 W - Valvole di sezione <i>Connecting cable: Compact 10 W - Section valves</i> <i>Câble de branchement: Compact 10 W - Vannes de section</i>	4V+P+G L = 3,0 m	COMPACT 10 W	1
C00902010 C4	Cavo collegamento: Compact 10 W - Valvole di sezione <i>Connecting cable: Compact 10 W - Section valves</i> <i>Câble de branchement: Compact 10 W - Vannes de section</i>	7V+P+G L = 3,0 m	COMPACT 10 W	1
C00902011 C4	Cavo collegamento: Compact 10 W - Valvole di sezione <i>Connecting cable: Compact 10 W - Section valves</i> <i>Câble de branchement: Compact 10 W - Vannes de section</i>	2V+P+G L = 5,0 m	COMPACT 10 W	1
C00902159 C4	Cavo collegamento: Compact 10 W - Valvole di sezione <i>Connecting cable: Compact 10 W - Section valves</i> <i>Câble de branchement: Compact 10 W - Vannes de section</i>	3V L = 5,0 m	COMPACT 10 W	1
C00902012 C4	Cavo collegamento: Compact 10 W - Valvole di sezione <i>Connecting cable: Compact 10 W - Section valves</i> <i>Câble de branchement: Compact 10 W - Vannes de section</i>	4V+P+G L = 5,0 m	COMPACT 10 W	1
C00902013 C4	Cavo collegamento: Compact 10 W - Valvole di sezione <i>Connecting cable: Compact 10 W - Section valves</i> <i>Câble de branchement: Compact 10 W - Vannes de section</i>	7V+P+G L = 5,0 m	COMPACT 10 W	1
C00902040 C4	Cavo collegamento: Compact 15 H - Valvole idrauliche - Tracciafile <i>Connecting cable: Compact 15 H - hydraulic valves - Foam marker</i> <i>Câble de branchement: Compact 15 H - Vannes oléohydrauliques - traceur de files</i>	2V 4 Connect. L = 3,0 m	COMPACT 15 H	1
C00902041 C4	Cavo collegamento: Compact 15 H - Valvole idrauliche - Tracciafile <i>Connecting cable: Compact 15 H - hydraulic valves - Foam marker</i> <i>Câble de branchement: Compact 15 H - Vannes oléohydrauliques - traceur de files</i>	4V 8 Connect. L = 3,0 m	COMPACT 15 H	1
C00902039 C4	Cavo collegamento: Compact 15 H - Valvole idrauliche <i>Connecting cable: Compact 15 H - hydraulic valves</i> <i>Câble de branchement: Compact 15 H - Vannes oléohydrauliques</i>	5V+G 11 Connect. L = 3,0 m	COMPACT 15 H	1
C00902043 C4	Cavo collegamento: Compact 15 H - Valvole idrauliche - Tracciafile <i>Connecting cable: Compact 15 H - hydraulic valves - Foam marker</i> <i>Câble de branchement: Compact 15 H - Vannes oléohydrauliques - traceur de files</i>	2V 4 Connect. L = 5,0 m	COMPACT 15 H	1
C00902044 C4	Cavo collegamento: Compact 15 H - Valvole idrauliche - Tracciafile <i>Connecting cable: Compact 15 H - hydraulic valves - Foam marker</i> <i>Câble de branchement: Compact 15 H - Vannes oléohydrauliques - traceur de files</i>	4V 8 Connect. L = 5,0 m	COMPACT 15 H	1
C00902042 C4	Cavo collegamento: Compact 15 H - Valvole idrauliche <i>Connecting cable: Compact 15 H - hydraulic valves</i> <i>Câble de branchement: Compact 15 H - Vannes oléohydrauliques</i>	5V+G 11 Connect. L = 5,0 m	COMPACT 15 H	1
C00902053 C4	Cavo collegamento: Compact 15 H - Valvole idrauliche - Tracciafile <i>Connecting cable: Compact 15 H - hydraulic valves - Foam marker</i> <i>Câble de branchement: Compact 15 H - Vannes oléohydrauliques - traceur de files</i>	5V+G L = 3,0 m	COMPACT 15 H	1
C00902054 C4	Cavo collegamento: Compact 15 H - Valvole idrauliche - Tracciafile <i>Connecting cable: Compact 15 H - hydraulic valves - Foam marker</i> <i>Câble de branchement: Compact 15 H - Vannes oléohydrauliques - traceur de files</i>	5V+G L = 5,0 m	COMPACT 15 H	1
C00902018 C4	Cavo collegamento: Compact 20 W - Valvole di sezione a solenoide <i>Connecting cable: Compact 20 W - Solenoid section valves</i> <i>Câble de branchement: Compact 20 W - Vannes de section à solénoïde</i>	2V+P L = 3,0 m	COMPACT 20 W-SOL	1
C00902019 C4	Cavo collegamento: Compact 20 W - Valvole di sezione a solenoide <i>Connecting cable: Compact 20 W - Solenoid section valves</i> <i>Câble de branchement: Compact 20 W - Vannes de section à solénoïde</i>	4V+P+G L = 3,0 m	COMPACT 20 W-SOL	1
C00902020 C4	Cavo collegamento: Compact 20 W - Valvole di sezione a solenoide <i>Connecting cable: Compact 20 W - Solenoid section valves</i> <i>Câble de branchement: Compact 20 W - Vannes de section à solénoïde</i>	2V+P L = 5,0 m	COMPACT 20 W-SOL	1
C00902021 C4	Cavo collegamento: Compact 20 W - Valvole di sezione a solenoide <i>Connecting cable: Compact 20 W - Solenoid section valves</i> <i>Câble de branchement: Compact 20 W - Vannes de section à solénoïde</i>	4V+P+G L = 5,0 m	COMPACT 20 W-SOL	1

Sensore di pressione

Pressure sensor

Capteur de pression



Part No.	L (m)	bar	mA	V dc	Pack
S02000026		20			
S02000010	5,0	50	4-20	12	1
S02000011		100			

Adatto per / Suitable to / Approprié à

GS 250 GS 260 GS 220 GS 210 GS 200

Cavo adattatore sensore di pressione

Pressure sensor adapter cable

Câble adaptateur capteur de pression



Part No.	L (m)	V dc	Pack
C00902029	0,5	12	1

Adatto per / Suitable to / Approprié à

GS 250 GS 260 GS 220 GS 210 GS 200

Sensore di livello completo di supporto per fissaggio

Level sensor complete with mounting bracket

Capteur de niveau avec support de fixation



Part No.	V dc	Pack
K00004002	12	1

Adatto per / Suitable to / Approprié à

GS 250 GS 260 GS 220 GS 200

Cavo collegamento Sensore di livello GS 200

Level sensor connecting cable GS 200

Câble de branchement capteur de niveau GS 200



Part No.	L (m)	V dc	Pack
C00902035	5,0	12	1

Adatto per / Suitable to / Approprié à

GS 200

Cavo collegamento Sensore di livello - Driver Box *Level sensor-Driver Box connecting cable*

Câble de branchement capteur de niveau - Driver Box



⚡

Part No.	L (m)	V dc	Pack
C00902046	5,0	12	1

Adatto per / Suitable to / Approprié à

GS 250 GS 260 GS 220 GS 200

Cavo adattatore sensore di livello

Level sensor adapter cable

Câble adaptateur capteur de niveau



⚡

Part No.	L (m)	V dc	Pack
C00902028	0,5	12	1

Adatto per / Suitable to / Approprié à

GS 250 GS 260 GS 220 GS 200

Cavo collegamento Monitor - Driver Box W

Monitor-Driver Box W connecting cable

Câble de branchement moniteur - Driver Box W



⚡

Part No.	L (m)	V dc	Pack
C00902002	11,0	12	1

Adatto per / Suitable to / Approprié à

GS 250 GS 260

Cavo connessione GS 200

GS 200 connecting cable

Câble de branchement GS 200



⚡

Part No.	No. Sensor	Type	L (m)	V dc	Pack
C00902036	1	D	2,0	12	1
C00902037	2	A+D			
NEW C00902058	2	D+D			
C00902038	4	2A+2D			

Sensor Type Connector

Pressure	A	Analogic
Level		
Flow	D	Digital
Speed		

Adatto per / Suitable to / Approprié à

GS 200

Cavo collegamento valvole: Sezione, Generale, Proportionale

Connecting cable to valves: Section, General, Proportional

Câble de branchement vannes : section, générale, proportionnelle



Part No.	L (m)	V dc	Pack
C00902001	6,0	12	1
C00902000	10,0	12	1

Adatto per / Suitable to / Approprié à

GS 250 GS 260

Cavo collegamento: Compact 10 W - Valvole di sezione

Connecting cable: Compact 10 W - Section valves

Câble de branchement: Compact 10 W - Vannes de section



Part No.	Type	L (m)	V dc	Pack
C00902008	2V+P+G			
C00902009	4V+P+G	3,0	12	1
C00902010	7V+P+G			
C00902011	2V+P+G			
C00902012	4V+P+G	5,0	12	1
C00902013	7V+P+G			

Adatto per / Suitable to / Approprié à

Compact 10 W

Cavo collegamento: Compact 15 H - Valvole idrauliche - Tracciafile

Connecting cable: Compact 15 H - hydraulic valves - Foam marker

Câble de branchement: Compact 15 H - Vannes oléohydrauliques - traceur de files



Part No.	Type	L (m)	V dc	Pack
C00902040	2V 4 Connect.	3,0	12	1
C00902041	4V 8 Connect.			
C00902043	2V 4 Connect.	5,0	12	1
C00902044	4V 8 Connect.			

Adatto per / Suitable to / Approprié à

Compact 15 H

Cavo collegamento: Compact 15 H - Valvole idrauliche

Connecting cable: Compact 15 H - hydraulic valves

Câble de branchement: Compact 15 H - Vannes oléohydrauliques



Part No.	Type	L (m)	V dc	Pack
C00902039	5V+G	3,0	12	1
C00902042	11 Connect.	5,0	12	1

Adatto per / Suitable to / Approprié à

Compact 15 H (2+3)

Cavo collegamento: Compact 20 W - Valvole di sezione a solenoide

Connecting cable: Compact 20 W - Solenoid section valves

Câble de branchement: Compact 20 W - Vannes de section à solénoïde



Part No.	Type	L (m)	V dc	Pack
C00902018	2V+P	3,0	12	1
C00902019	4V+P+G			
C00902020	2V+P	5,0	12	1
C00902021	4V+P+G			

Adatto per / Suitable to / Approprié à

Compact 20 W-SOL

Prolunga per cavo collegamento Monitor - Driver Box W

Extension for Monitor-Driver Box W connecting cable

Rallonge pour câble de branchement Moniteur - Driver Box



Part No.	L (m)	V dc	Pack
C00902022	3,0	12	1
C00902005	5,0	12	1

Adatto per / Suitable to / Approprié à

GS 250 GS 260

Prolunga per cavo collegamento Monitor - Driver Box H

Extension for Monitor-Driver Box H connecting cable

Rallonge pour câble de branchement Moniteur - Driver Box H



Part No.	L (m)	V dc	Pack
C00902003	3,0	12	1
C00902004	5,0	12	1

Adatto per / Suitable to / Approprié à

GS 250 GS 260

Prolunga per cavo collegamento valvole + sensore

Extension for valves + sensor connecting cable

Rallonge pour câble de branchement vannes + capteur



Part No.	Type	L (m)	V dc	Pack
C00902016	M-F 2/4V+P+G	3,0	12	1
C00902017	M-F 24P	5,0	12	1
C00902030	M-F 24P	7,0	12	1

Adatto per / Suitable to / Approprié à

GS 220 GS 210 Compact 10 W

Prolunga per collegamento Compact 10 W -
Cavo valvole sezione.

Extension for Compact 10 W - Cable for section
valve

Rallonge pour branchement Compact 10 W -
Câble vanne de section



Part No.	Type	L (m)	V dc	Pack
C00902014	M-F	3,0	12	1
C00902015	6 Switches	5,0	12	1

Adatto per / Suitable to / Approprié à

Compact 10 W Compact 20 W-SOL

Prolunga per cavo collegamento Compact 15 H -
Driver Box H

Extension for Compact 15 H + Driver Box H
connecting cable

Rallonge pour branchement câble Compact 15 H
- Driver Box H



Part No.	Type	L (m)	V dc	Pack
C00902045	M-F	5,0	12	1

Adatto per / Suitable to / Approprié à

Compact 15 H

Antenna GPS

Fornisce ai computer Geosystem un accurato calcolo della posizione e precisa misura della velocità, evitando l'installazione del sensore di prossimità sulla ruota

- Calcolo della posizione attraverso i segnali GPS, GLONASS, GALILEO, QZSS;
- Compatibile con i segnali di correzione SBAS (WAAS, EGNOS, MSAS, GAGAN);
- Supporta 99 canali GNSS;
- Aggiornamento della posizione 10 volte al secondo (10 HZ);
- Basso consumo energetico;
- Indicatore led della posizione;
- Magneti incorporati per una rapida installazione;
- Waterproof;
- Cablaggio semplificato;
- Disponibile per i computer Geosystem 260;
- +12 [V]

GPS antenna

It provides to Geosystem computer an accurate calculation of position and a speed measure, in order to avoid the proximity sensor installed on the wheel.

- Support GPS, GLONASS, GALILEO and QZSS;
- Capable of SBAS (WAAS, EGNOS, MSAS, GAGAN);
- Support 99-channel GNSS;
- Up to 10Hz update rate;
- Ultra low power consumption;
- Led indicator of position status;
- Built-in magnets for a quick installation;
- Waterproof;
- Quick cabling;
- Available for computer Geosystem 260;
- +12 [V]

Antenne GPS

Il apporte à l'ordinateur Geosystem un calcul de position précise et une mesure de vitesse, afin d'éviter le capteur de proximité installé sur la roue

- Assistance GPS, GLONASS, GALILEO et QZSS;
- Capable de SBAS (WAAS, EGNOS, MSAS, GAGAN);
- Support du GNSS à 99 canaux;
- Taux de mise à jour jusqu'à 10 Hz;
- Consommation à très basse consommation;
- Indicateur LED du statut de position;
- Des aimants intégrés pour une installation rapide;
- Waterproof;
- Câblage rapide;
- Disponible pour ordinateur Geosystem 260;
- +12 [V]



Part No.	V dc	Pack
A01100002	12	1

Adatto per / Suitable to / Approprié à

GS 260

Cavo di collegamento per Geosystem 260 con navigatore GPS esterno tramite protocollo T.U.V.R. T.U.V.R. è un protocollo esclusivo **Trimble®** per il controllo delle attrezzature.

Consente l'apertura e chiusura automatica delle sezioni di barra in base alle indicazioni del navigatore GPS esterno **Trimble®**.

Connection cable for Geosystem 260 with external GPS satnav via T.U.V.R. protocol
T.U.V.R. is an exclusive **Trimble®** control protocol. It allows automatic opening and closing of bar sections on the basis of the external **Trimble®** GPS navigator.

Câble de branchement pour Geosystem 260 avec navigateur GPS externe via protocole T.U.V.R. Le T.U.V.R. est un protocole exclusif **Trimble®** de contrôle des équipements.

Il permet l'ouverture et la fermeture automatique des sections de barre en fonction des indications du navigateur GPS externe **Trimble®**.



Part No.	L (m)	Pack
----------	-------	------

C00902149	2	1
-----------	---	---

Adatto per / Suitable to / Approprié à

GS 260 CS GS 260 CS H

Staffa ventosa con sfera + Supporto a sfera per fissaggio monitor

Suction cup bracket with ball + Monitor holder with ball.

Bride ventouse à bille + Support à bille pour fixation moniteur.



Part No.	Pack
----------	------

V00700001	1
-----------	---

Adatto per / Suitable to / Approprié à

GS 260 GS 250 GS 220 GS 210

Staffa da palo con sfera (senza braccio di completamento)

Pole bracket with ball (without supplementary arm)

Bride de montant à bille (sans bras complémentaire)

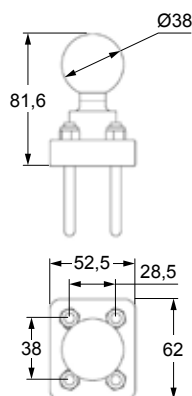

Part No.	Pack
----------	------

S00400063	1
-----------	---

Adatto per / Suitable to / Approprié à

GS 260 GS 250 GS 220 GS 210

Staffa da palo + Braccio + Supporto a sfera per fissaggio monitor

Pole bracket + Arm + Monitor holder with ball

Bride de montant + Bras + Support à bille pour fixation moniteur



Part No. Pack

K00701010 1

Adatto per / Suitable to / Approprié à

GS 260 GS 250 GS 220 GS 210

Braccio + Supporto a sfera per fissaggio monitor

Arm + Monitor holder with ball

Bras + Support à bille pour fixation moniteur



Part No. Pack

K00701011 1

Adatto per / Suitable to / Approprié à

GS 260 GS 250 GS 220 GS 210

Supporto a sfera per fissaggio monitor

Monitor holder with ball

Support à bille pour fixation moniteur

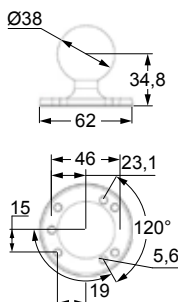

Part No. Pack

S00400064 1

Adatto per / Suitable to / Approprié à

GS 260 GS 250 GS 220 GS 210

Staffa ventosa con sfera

Suction cup bracket with ball

Bride ventouse à bille

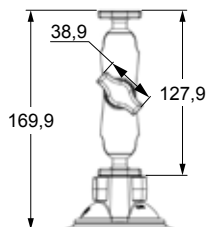

Part No. Pack

V00700002 1

Adatto per / Suitable to / Approprié à

GS 200

Staffa da palo + Braccio + Supporto a sfera per fissaggio monitor

Pole bracket + Arm + Monitor holder with ball

Bride de montant + Bras + Support à bille pour fixation moniteur

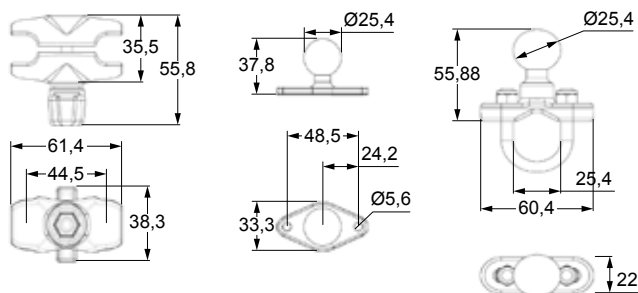

Part No.	Pack
K00701012	1

Adatto per / Suitable to / Approprié à

GS 200

Staffa da palo + Braccio + Supporto a sfera per fissaggio monitor

Pole bracket + Arm + Monitor holder with ball

Bride de montant + Bras + Support à bille pour fixation moniteur

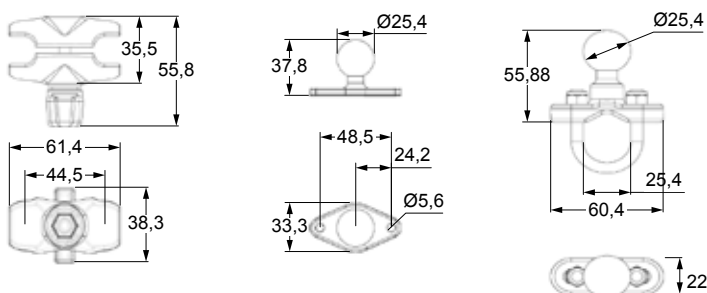

NEW

Part No.	Pack
K00701013	1

Adatto per / Suitable to / Approprié à

GS 200

Kit per il collegamento di un tracciabile ad un computer o ad una scatola idraulica di comando. Stop pompa GS200.

Wiring kit to connect a foam marker to a computer or to a hydraulic control box. Pump stop GS200.

Kit de branchement du traceur à mousse à boîtier électrique ou bien à une boîte de commande hydraulique. Arrêt de pompe GS200.



Part No.	°C	V dc	Pack
8394016	60	12	1

Adatto per / Suitable to / Approprié à













GS 260 CS GS 250 CS GS 200
GS 260 CS H GS 250 CS H

SPARE PARTS



Part No.	Description	Type	Suitable for	Pack
D00601000	Scatola di derivazione Driver Box W <i>Connecting box: Driver Box W</i> <i>Boîtier de dérivation Driver Box W</i>	3W	GS 250 CS GS 250 CS H GS 250 OS GS 250 MRS GS 260 CS GS 260 CS H GS 260 OS GS 260 MRS GS 260 MRS H	1
D00601002	Scatola di derivazione Driver Box W <i>Connecting box: Driver Box W</i> <i>Boîtier de dérivation Driver Box W</i>	5W		1
D00601003	Scatola di derivazione Driver Box W <i>Connecting box: Driver Box W</i> <i>Boîtier de dérivation Driver Box W</i>	7W		1
D00601008	Scatola di derivazione Driver Box H <i>Connecting box: Driver Box H</i> <i>Boîtier de dérivation Driver Box H</i>	2H		1
D00601009	Scatola di derivazione Driver Box H <i>Connecting box: Driver Box H</i> <i>Boîtier de dérivation Driver Box H</i>	5H	GS 250 CS H GS 260 CS H GS 260 MRS H	1
D00601010	Scatola di derivazione Driver Box H <i>Connecting box: Driver Box H</i> <i>Boîtier de dérivation Driver Box H</i>	7H		1
D00601011	Scatola di derivazione Driver Box H <i>Connecting box: Driver Box H</i> <i>Boîtier de dérivation Driver Box H</i>	9H		1
D00602000	Scatola di derivazione Driver Box Compact 15 H <i>Connecting box: Driver Box H</i> <i>Boîtier de dérivation Driver Box H</i>	7-9H	Compact 15 H	1
C00902006	Cavo collegamento Monitor - Driver Box W <i>Connecting cable Monitor - Driver Box W</i> <i>Câble de branchement Monitor - Driver Box W</i>	L = 5,0 m	GS 250 GS 260	1
C00902007	Cavo collegamento Monitor - Driver Box H <i>Connecting cable Monitor - Driver Box H</i> <i>Câble de branchement Monitor - Driver Box H</i>	L = 5,0 m	GS 250 CS H GS 260 CS H	1
C00902023	Cavo collegamento valvole: Sezione, Generale, Proporzionale <i>Connecting cable to valves: Section, Main, Proportional</i> <i>Câble de branchement vannes : section, générale, proportionnelle</i>	L = 1,2 m	GS 250 GS 260	1
C00902024	Cavo collegamento valvole: Sezione, Generale, Proporzionale <i>Connecting cable to valves: Section, Main, Proportional</i> <i>Câble de branchement vannes : section, générale, proportionnelle</i>	L = 1,2 m	GS 250 CS H GS 260 CS H	1
C00902025	Cavo collegamento valvola Sezione Oleodinamica <i>Connecting cable for hydraulic section valve</i> <i>Câble de branchement vanne de section oléohydraulique</i>	L = 1,2 m	GS 250 CS H GS 260 CS H	1

SPARE PARTS

Part No.	Description	Type	Suitable for	Pack
C00902026	Cavo collegamento tracciafile <i>Foam marker connecting cable</i> <i>Câble de branchement traceur de files</i>	L = 0,4 m	GS 250 CS / CS H GS 260 CS / CS H	 1
C00902027	Cavo adattatore flussometro <i>Flow meter adapter cable</i> <i>Câble adaptateur débitmètre</i>	L = 0,5 m	GS 250 GS 260	 1
S02000009	Sensore di velocità <i>Speed sensor</i> <i>Capteur de vitesse</i>	L = 5,0 m	GS 260 GS 250 GS 220	 1
C00902017	Prolunga per cavo collegamento valvole + sensore <i>Extension for valves + sensor connecting cable</i> <i>Rallonge pour câble de branchement vannes + capteur</i>	MF 24P L = 5,0 m	GS 210 GS 220	 1
C00902016	Prolunga per cavo collegamento valvole + sensore <i>Extension for valves + sensor connecting cable</i> <i>Rallonge pour câble de branchement vannes + capteur</i>	MF 24P L = 3,0 m	GS 210 GS 220 Compact 10 W	 1
C00902047	Cavo collegamento valvole + sensore <i>Connecting cable for valves + sensor</i> <i>Câble de branchement vannes + capteur</i>	2W 4Sens. L = 1,2 m	GS 220	 1
C00902048	Cavo collegamento valvole + sensore <i>Connecting cable for valves + sensor</i> <i>Câble de branchement vannes + capteur</i>	4W 4Sens. L = 1,2 m	GS 220	 1
C00902031	Cavo collegamento valvole + sensore <i>Connecting cable for valves + sensor</i> <i>Câble de branchement vannes + capteur</i>	2W+P +G 1 sens.	GS 210	 1
C00902032	Cavo collegamento valvole + sensore <i>Connecting cable for valves + sensor</i> <i>Câble de branchement vannes + capteur</i>	3W+P +G input 1 sens.	GS 210	 1
C00902033	Cavo collegamento valvole + sensore <i>Connecting cable for valves + sensor</i> <i>Câble de branchement vannes + capteur</i>	5W+P +G 1 sens.	GS 210	 1
C00902034	Cavo collegamento valvole + sensore <i>Connecting cable for valves + sensor</i> <i>Câble de branchement vannes + capteur</i>	7W+P +G 1 sens.	GS 210	 1
S00400065	Staffa di fissaggio <i>Fixing support</i> <i>Support de fixation</i>		GS 260 GS 250 GS 260 GS 210	 1

Scatole comando predisposte per manometro.
A 2-3-5 sezioni.
****RD:** dove la valvola generale in OFF chiude automaticamente tutte le valvole di sezione.
***RI:** con valvole di sezione indipendenti.

Control boxes to be completed with pressure gauge.
With 2-3-5 section valves.
****RD:** with section valves controlled by the main valve.
***RI:** with independent section valves.

Boîtiers de commande à compléter avec manomètre.
A 2-3-5 vannes de section.
****RD:** où la vanne générale en OFF serre toutes les sections.
***RI:** avec vannes de section indépendantes.



Campo di impiego / Use / Utilisation



FEATURES

kg ~1
 °C 60
 V dc 12

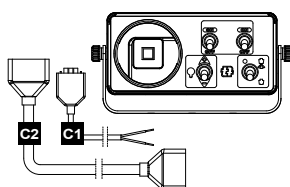

Part No.	Type	Section Valves V	Volumetric Valve P	Main Valve G	C1 L (m)	C2 L (m)	Pack
----------	------	---------------------	-----------------------	-----------------	-------------	-------------	------

8406001 ***RI** 2 1 1 2,0 3,0 1

8406007 ****RD** 2 1 1 2,0 3,0

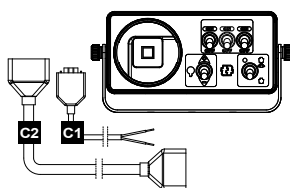

8406003 ***RI** 3 1 1 2,0 3,0 1

8406009 ****RD** 3 1 1 2,0 3,0 1

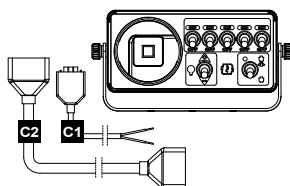

8406005 ***RI** 5 1 1 2,0 3,0 1

8406011 ****RD** 5 1 1 2,0 3,0 1

INSTALLATION

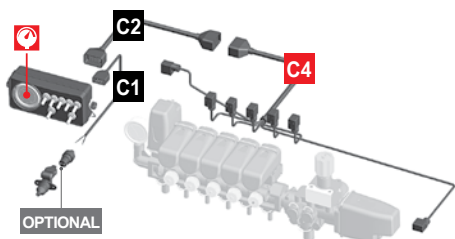

Obbligatorio ordinare il cavo C4 separatamente.
Compulsory: cable C4 to be ordered separately.
Obligatoire: commander le cable C4 séparément.

OPTIONALS

Part No.	LIQUID SEPARATOR	PLUGS
	Pag. 54	Pag. 56
8406001	>	>
8406007	>	>
8406003	>	>
8406009	>	>
8406005	>	>
8406011	>	>

C4 - END CABLE	
L = 3,0 m Part No.	L = 5,0 m Part No.
C00900006	C00900007
C00900006	C00900007
C00900008	C00900009
C00900008	C00900009
C00900010	C00900011
C00900010	C00900011

Pag. 57



PRESSURE GAUGE

Pag. 326



Scatole comando

A 2-3-5 sezioni.

****RD:** dove la valvola generale in OFF chiude automaticamente tutte le valvole di sezione.

***RI:** con valvole di sezione indipendenti.

Control boxes

With 2-3-5 section valves.

****RD:** with section valves controlled by the main valve.

***RI:** with independent section valves.

Boîtiers de commande

A 2-3-5 vannes de section.

****RD:** où la vanne générale en OFF serre toutes les sections.

***RI:** avec vannes de section indépendantes.



Campo di impiego / Use / Utilisation



FEATURES

kg	°C	V dc	A
~1	60	12	< 0,5

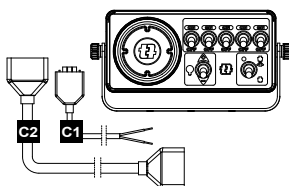
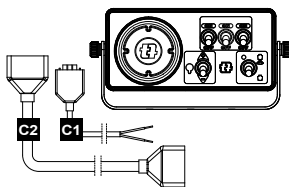
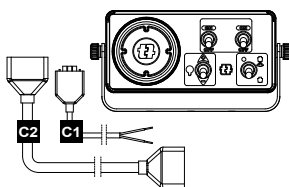

Part No.	Type	Section Valves V	Volumetric Valve P	Main Valve G	C1 L (m)	C2 L (m)	Pack
8406000	*RI	2	1	1	2,0	3,0	1
8406006	**RD	2	1	1	2,0	3,0	
8406002	*RI	3	1	1	2,0	3,0	1
8406008	**RD	3	1	1	2,0	3,0	1
8406004	*RI	5	1	1	2,0	3,0	1
8406010	**RD	5	1	1	2,0	3,0	1

INSTALLATION

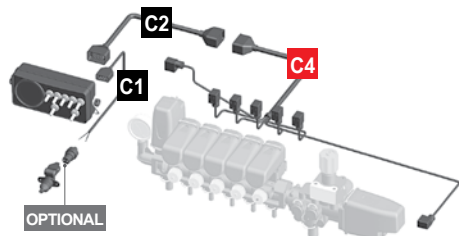

Obbligatorio ordinare il cavo C4 separatamente.
Compulsory: cable C4 to be ordered separately.
Obligatoire: commander le câble C4 séparément.

OPTIONALS

Part No.	LIQUID SEPARATOR	PLUGS
	Pag. 54	Pag. 56
8406000		
8406006		
8406002		
8406008		
8406004		
8406010		

C4 - END CABLE	
L = 3,0 m Part No.	L = 5,0 m Part No.
C00900006	C00900007
C00900006	C00900007
C00900008	C00900009
C00900008	C00900009
C00900010	C00900011
C00900010	C00900011

Pag. 57



Separatore di liquidi

Consente l'uso del manometro in cabina senza la presenza di prodotti chimici. Il riempimento può essere fatto con glicerina o acqua. Può essere utilizzato con qualsiasi tipo di scatole comando.

- Corpo in acciaio inox 303
- Particolari in alluminio Anticorodal
- Membrana in viton di serie
- Grano di spurgo in acciaio inox
- Disponibile con filettature NPT e BSP

Liquid separator.

Allows the use of pressure gauge without chemicals in the cab. Refilling may be done with glycerin or water. It may be used with any kind of control units.

- 303 Inox Body
- Anticorodal aluminium parts
- Viton Diaphragm as standard
- Drain-off in stainless steel
- Available with NPT or BSP threads

Séparateur de liquides.

Il permet l'utilisation du manomètre en cabine, sans la présence des produits chimiques. Le remplissage peut s'effectuer par glycerine ou bien à l'eau. Il peut être utilisé pour n'importe quelle boîte de commande

- Corps en acier inoxydable 303
- Parties en aluminium anticorodal
- Membrane en viton de standard
- Grain de nettoyage (vidange) en acier inoxydable
- Existe en version filetage NPT ou BSP.

INSTALLATION

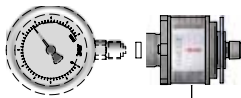

Non compreso nel kit.
Not included.
Non compris dans le kit



Part No.	F1	F2	bar	Pack
8392064	G 1/4 F	G 1/4 M		1
8392065	1/4 NPT F	1/4 NPT M	20	1
8392066	G 1/8 F	G 1/8 M		1
8392067	1/8 NPT F	1/8 NPT M		1

INSTALLATION

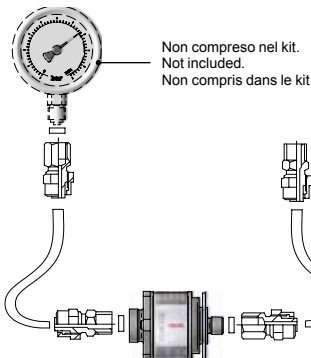

Non compreso nel kit.
Not included.
Non compris dans le kit



- Il kit è completo di tubo in rilsan, di raccordi e di ampolla per il caricamento.
- This kit comes complete with Rilsan pipe, fittings and bottle for refilling.
- Ce kit est pourvu de tuyau en Rilsan, raccords et ampoule de remplissage.



Part No.	F1	F2	bar	Pack
8392068	G 1/4 F	G 1/4 M	20	1
8392070	G 1/8 F	G 1/8 M		1

Part No.	F1	F2	bar	Pack
8392069	1/4 NPT F	1/4 NPT M	20	1
8392071	1/8 NPT F	1/8 NPT M		1

Cavo di alimentazione elettrovalvole. Adatto per tutte le valvole serie NRG, a 2 fili.

Connecting cable for NRG series, 2 wire valves.

Câble de branchement pour vanes électriques à 2 fils, série NRG.



Part No.	°C	V dc	Pack
S00800000	60	12	1



Part No.	L (m)	°C	V dc	Pack
C00900003	2,1	60	12	1
NEW C00902123	5,1			

Cavo di alimentazione per valvole elettriche a solenoide, completo di guarnizione e vite di fissaggio.
Dotato di led segnalazione valvola aperta.

Power supply cable for solenoid valves with fittings and screw.
Open valve led indicator included.

Câble de branchement pour vanes électriques à solénoïde avec joint et vis de fixation.
Équipé d'un diode indiquant que la vanne est ouverte.





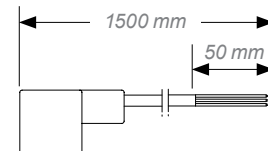









Part No.	L mm	°C	V dc	Pack
C00900021	1500	60	12	1



OPTIONALS



Part No.	Description	Type	Suitable for	Pack
K00102040	 <p>Presà-spina di alimentazione Power socket-plug Prise-fiche d'alimentation</p>	2 PIN		1
K00102044	 <p>Presà-spina di alimentazione Power socket-plug Prise-fiche d'alimentation</p>	3 PIN		1
S00800001	 <p>Spina alimentaz. accendisigari Cigarette lighter power plug Fiche alimentation allume-cigare</p>			1
8392064 8392065 8392066 8392067	 <p>Separatore di liquidi Liquid separator. Séparateur de liquides.</p>			 1
8392068 8392070	 <p>Pag. 54 Separatore di liquidi Liquid separator. Séparateur de liquides.</p>			 1
8392069 8392071	 <p>Separatore di liquidi Liquid separator. Séparateur de liquides.</p>			 1











END CABLES



Part No.	Type	Suitable for	Pack
C00900006	C4 Cavo di completamento End cable Cable de integration L = 3,0 m (10 feet)	2 Section Valves	 1
C00900007	C4 Cavo di completamento End cable Cable de integration L = 5,0 m (16,5 feet)		
C00900008	C4 Cavo di completamento End cable Cable de integration L = 3,0 m (10 feet)	3 Section Valves	 1
C00900009	C4 Cavo di completamento End cable Cable de integration L = 5,0 m (16,5 feet)		
C00900010	C4 Cavo di completamento End cable Cable de integration L = 3,0 m (10 feet)	5 Section Valves	 1
C00900011	C4 Cavo di completamento End cable Cable de integration L = 5,0 m (16,5 feet)		
	Manometri Pressure gauges Manomètres Pag. 326		 5
	Manometri Pressure gauges Manomètres Pag. 326		 5

LEGENDA



Campo di impiego / Use / Utilisation

	Per macchine a basso volume <i>For low-volume spraying machines</i> <i>Pour machines basse volum</i>		Per atomizzatori <i>For orchard sprayers</i> <i>Pour atomiseurs</i>		Per macchine da diserbo <i>For crop sprayers</i> <i>Pour pulvérisateurs</i>
	Componente modulare <i>Modular component</i> <i>Composant modulaire</i>		Adatto per computers GeoSystem <i>Suitable to computers GeoSystem</i> <i>Approprié à ordinateurs GeoSystem</i>		Sistema di comando senza fili <i>Wireless control system</i> <i>Système de commande sans câbles</i>
	Adatto per distributori olio idraulico <i>Suitable to hydraulic oil distributors</i> <i>Approprié à groupe de distribution huile hydraulique</i>		Valvole di sezione serie NRG <i>Section valve NRG series</i> <i>Vanne de section séries NRG</i>		Valvole di sezione serie NRG PLUS <i>Section valve NRG PLUS series</i> <i>Vanne de section séries NRG PLUS</i>

Caratteristiche / Features / Caractéristiques

	Portata della pompa <i>Pump flow rate</i> <i>Débit de la pompe</i>		Portata <i>Flow rate</i> <i>Débit</i>		Pressione d'esercizio <i>Operating pressure</i> <i>Pression de service</i>
	Temperatura max <i>Max temperature</i> <i>Temperature maxi</i>		Tensione di alimentazione <i>Working voltage</i> <i>Tension d'alimentation</i>		Tempo di azionamento <i>Operating time</i> <i>Durée de l'actionnement</i>
	Portagomma <i>Hosetail</i> <i>Porte-tuyau</i>		Peso <i>Weight</i> <i>Poids</i>		Per testine attacco rapido <i>For quick fitting caps</i> <i>Pour têtes à raccord rapide</i>
	Assorbimento elettrico <i>Power consumption</i> <i>Absorption électrique</i>				

Accessori da ordinare separatamente Accessories to be ordered separately Accessoires à commander séparément

	IN Portagomma di entrata valvole generali <i>Inlet hosetails for main valves</i> <i>Porte-tuyau d'entrée pour vanne générale</i>
	OUT Portagomma di uscita valvole di sezione <i>Outlet hosetails for section valves</i> <i>Porte-tuyau de sortie pour vanne de section</i>
	BY-PASS Portagomma by-pass valvola generale <i>Hosetails by-pass for main valves</i> <i>Porte-tuyau by-pass pour vanne générale</i>
	ADAPTERS Flange / Portagomma per valvole elettriche <i>Adapters / Hosetails for electric valves</i> <i>Brides / Porte-tuyau pour vannes électriques</i>

Accessori opzionali Optionals Accessoires optionals

	Manometri <i>Pressure gauges</i> <i>Manomètres</i>
	Cavo di completamento <i>End cables</i> <i>Cables de integration</i>
	Scatole di comando <i>Control boxes</i> <i>Boîtiers électriques</i>
	Computers serie GeoSystem <i>Computers GeoSystem series</i> <i>Ordinateurs GeoSystem série</i>
	Kit assemblaggio valvole <i>Assembling kit for valves</i> <i>Kit d'assemblage pour vannes</i>
	Collettori / Portagomma / Tappi <i>Manifolds / Hosetails / Plugs</i> <i>Collecteurs / Porte-tuyau / bouchon</i>
	Flange / Portagomma per valvole elettriche <i>Adapters / Hosetails for electric valves</i> <i>Brides / Porte-tuyau pour vannes électriques</i>
	Dispositivo scarico pressione <i>Exhaust device</i> <i>Dispositif de décharge pression</i>

FEATURES

	Prodotti non per uso alimentare <i>Products not for food use</i> <i>Produits non pour un usage alimentaire</i>
---	--

Gruppi di comando

I gruppi di comando GEOLINE sono realizzati con i migliori materiali plastici e le migliori gomme.

Le parti in metallo sono in acciaio inox AISI 303 o in ottone per garantire la massima affidabilità e durata.

Control units

All GEOLINE control units are made with the best quality plastic and rubber materials. The internal metal components are in stainless steel AISI 303 to ensure the utmost reliability and long life.

Groupes de commande

Les groupes de commande GEOLINE ont été fabriqués avec les matériaux plastiques et de caoutchouc les meilleurs, afin de garantir une fiabilité et une durée optimale.



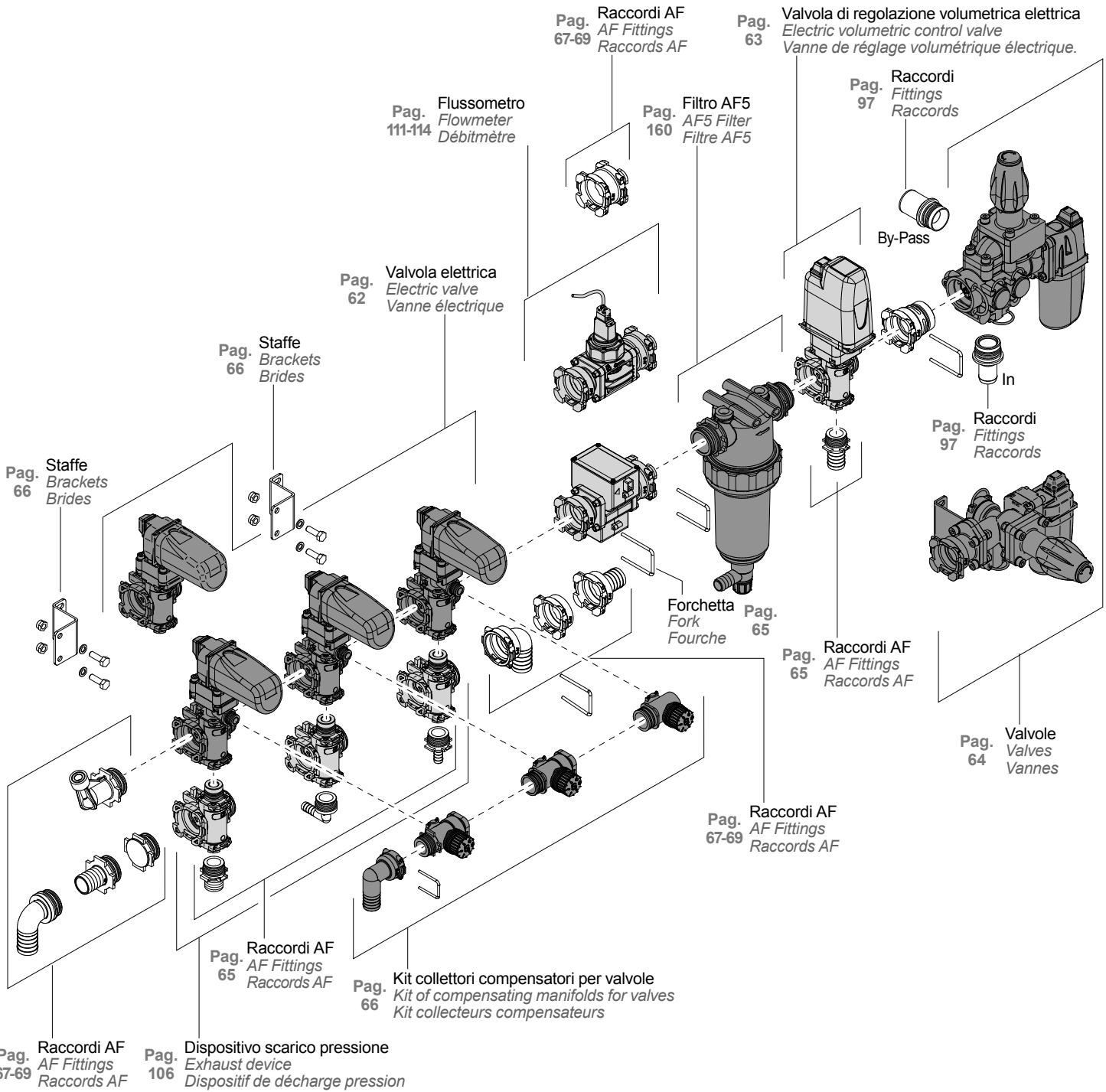

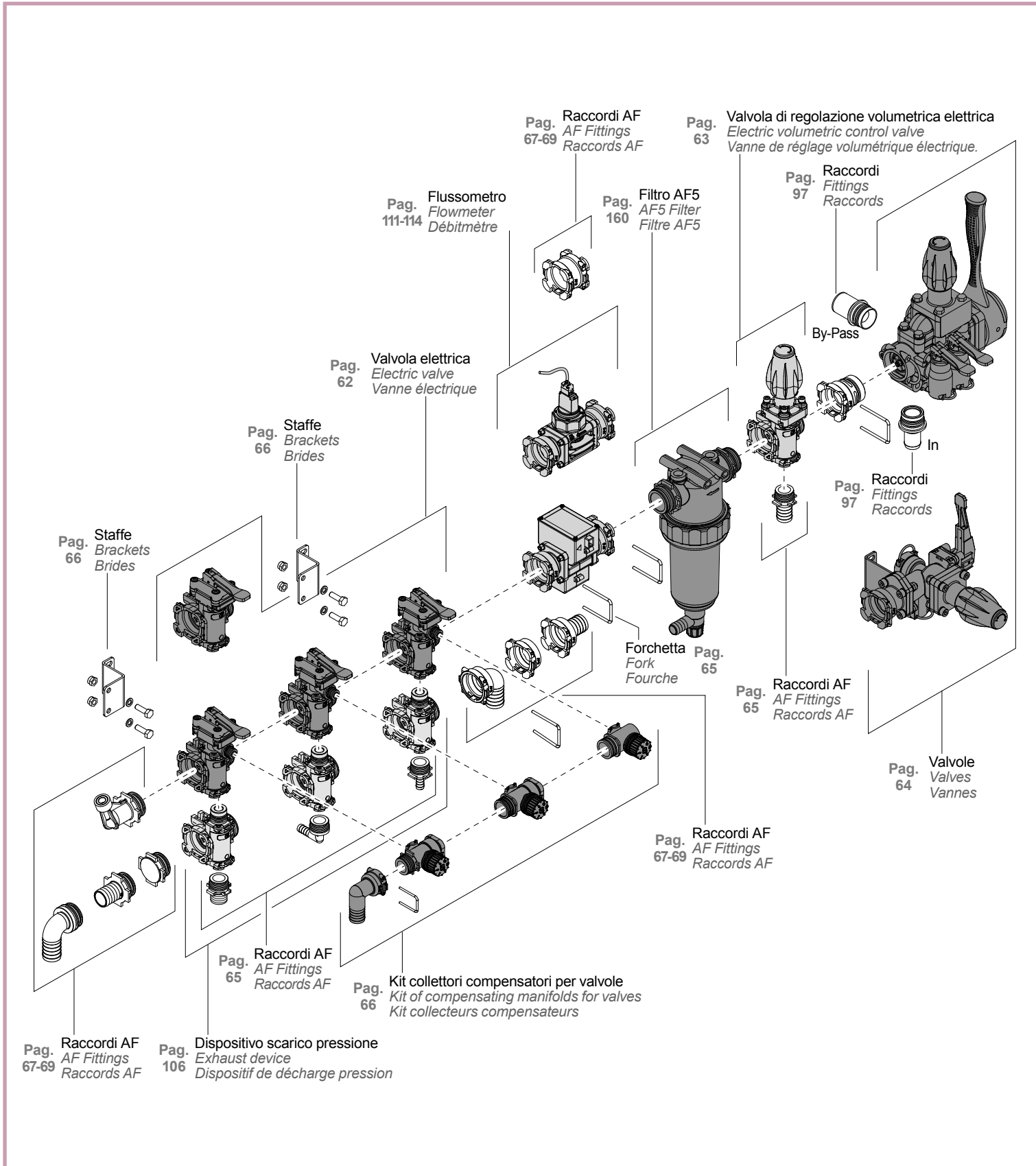

Valvola elettrica On/Off di sezione per barra.
Attacco a forchetta.

On/Off electric section valve for spraying boom
and orchard sprayers. Fork couplings.

Vanne électrique de section On/Off, pour rampe
de désherbage et atomiseurs. Raccords à fourche.

NRG-AF

NEW



Part No.	I/1'	bar	sec	°C	V dc	Pack
8388022	15*+45*	20	0,20	60	12	1

3W NRG-AF

NEW



Part No.	I/1'	bar	sec	°C	V dc	Pack
8388023	15*+45*	20	0,20	60	12	1



Obbligatorio ordinare separatamente.
Compulsory: to be ordered separately.
Obligatoire commander séparément.

AF Pag. 65 **AF** Pag. 67-69 **AF** Pag. 66 **AF** Pag. 66
OUT

OPTIONALS

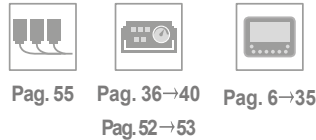

Pag. 55 Pag. 36→40 Pag. 6→35
Pag. 52→53

* Valore variabile in funzione del diametro del portagomma, con pressione di 0,5bar.
* Value varies depending on diameter of hose-tail, with 0,5bar pressure.
* Valeur variant en fonction du diamètre du raccord, avec pression de 0,5bar.



Valvola manuale On/Off di sezione per barra.
Attacco a forchetta.

Manual On/Off section valve for spraying boom
and orchard sprayers. Fork couplings.

Vanne manuelle de section On/Off, pour rampe de
désherbage et atomiseurs. Raccords à fourche.

NRG-AF

NEW



Part No.	I/1'	bar	°C	Pack
8388024	15* ÷ 45*	20	60	1

3W NRG-AF

NEW



Part No.	I/1'	bar	°C	Pack
8388025	15* ÷ 45*	20	60	1

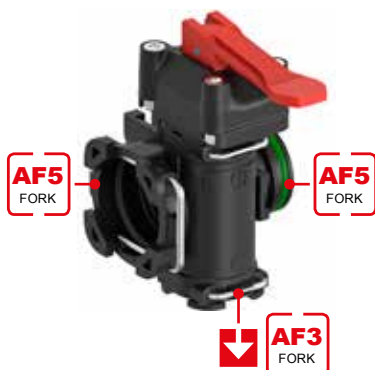

Obbligatorio ordinare separatamente.
Compulsory: to be ordered separately.
Obligatoire commander séparément.

AF Pag. 65 **AF** Pag. 67-69 **AF** Pag. 66 **AF** Pag. 66
OUT

* Valore variabile in funzione del diametro del portagomma, con pressione di 0,5bar.
* Value varies depending on diameter of hose-tail, with 0,5bar pressure.
* Valeur variant en fonction du diamètre du raccord, avec pression de 0,5bar.

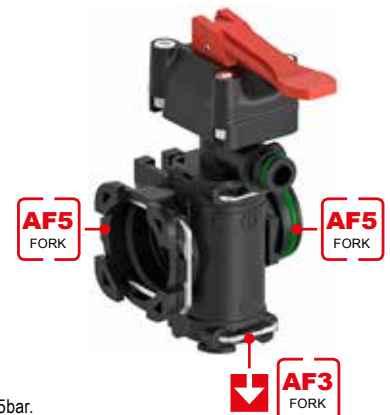

A 3 VIE / 3-WAY / A 3 VOIES

Valvola di regolazione volumetrica elettrica.
Attacco a forchetta.

Questa nuova valvola adotta soluzioni tecniche che consentono di utilizzare tutti raccordi di uscita "AF3", indipendentemente dalla portata.

Electric volumetric control valve.
Fork couplings.

This new valve features technical solutions that allow the use of "AF3" output fittings for all flow ranges.

Vanne volumétrique électrique.
Raccords à fourche.

Cette nouvelle vanne adopte des solutions techniques qui vous permettent d'utiliser tous les raccords de Sortie "AF3", quel que soit le débit

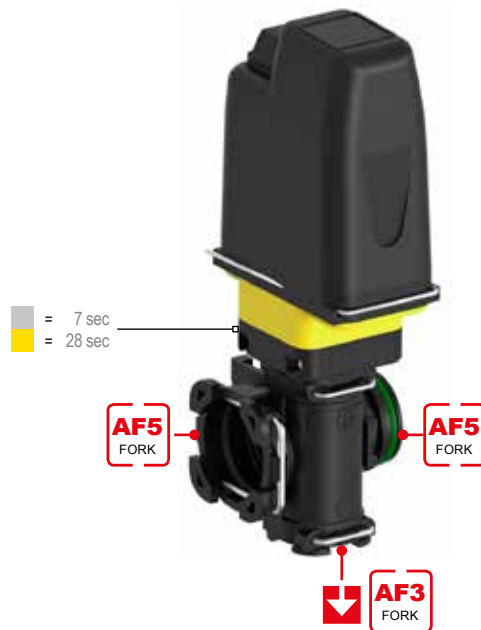

OPTIONALS



Pag. 55



Pag. 36→40
Pag. 52→53



Pag. 6→35

NRG-AF NEW

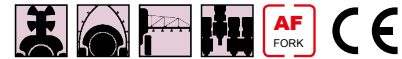

Part No.	I/1"	bar	sec	°C	V dc	Pack
8386032	100	40	7	60	12	1
8386033	150	20	7	60	12	1
8386026	100	40	28	60	12	1
8386027	150	40	28	60	12	1

Obbligatorio ordinare separatamente.
Compulsory: to be ordered separately.
Obligatoire commander séparément.

AF Pag. 65 **OUT** **AF** Pag. 67-69 **AF** Pag. 66 **AF** Pag. 66

Valvole di regolazione volumetriche manuali.
Attacco a forchetta.

Questa nuova valvola adotta soluzioni tecniche che consentono di utilizzare tutti raccordi di uscita "AF3", indipendentemente dalla portata della valvola stessa.

Manual volumetric control valves.
Fork couplings.

This new valve features technical solutions that allow the use of "AF3" output fittings for all flow ranges.

Vannes volumétrique manuelles.
Raccords à fourche.

Cette nouvelle vanne adopte des solutions techniques qui vous permettent d'utiliser tous les raccords de Sortie "AF3", quel que soit le débit.



NRG-AF NEW



Part No.	I/1"	bar	°C	Pack
8386028	100	40	60	1
8386029	150	40	60	1

Obbligatorio ordinare separatamente.
Compulsory: to be ordered separately.
Obligatoire commander séparément.

AF Pag. 65 **OUT** **AF** Pag. 67-69 **AF** Pag. 66 **AF** Pag. 66

Valvola elettrica di comando generale (ad azionamento elettrico) con valvola regolabile di massima pressione (manuale).
Attacco a forchetta.

Electric main control valve with manual adjustable pressure relief valve.
Fork couplings.

Vanne générale électrique avec vanne manuelle réglable de pression maxi.
Raccords à fourche.

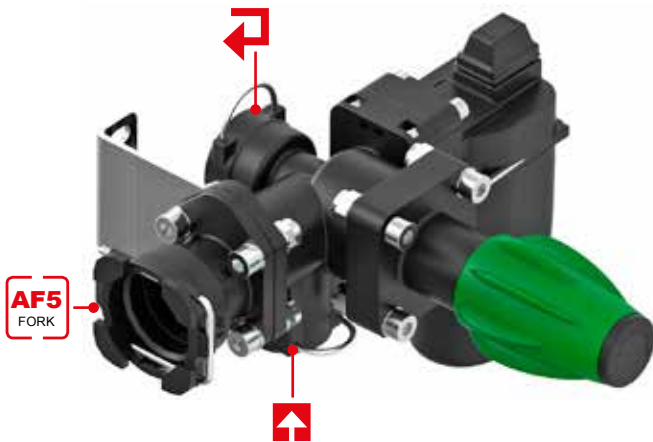

VGME 4-AF

NEW

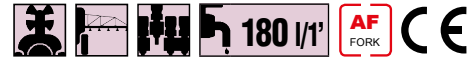

Part No.	l/1'	bar	sec	°C	V dc	Type	Pack
8370032	<60	20				"A"	1
8370033	180	10	0,2	60	12	"A"	1
8370034		20				"A"	1

"A" = a 2 fili / 2 wires / 2 fils

OPTIONALS



Pag. 55



Pag. 36→40
Pag. 52→53



Pag. 6→35



Obbligatorio ordinare i raccordi separatamente.
Compulsory: fitting to be ordered separately.
Obligatoire: commander les raccords séparément.

IN
Pag. 97

BY-PASS
Pag. 97

Valvola di comando generale manuale con valvola regolabile di massima pressione manuale.

Manual main control valve with manual adjustable pressure relief valve.

Vanne générale manuelle avec vanne manuelle réglable de pression maxi.

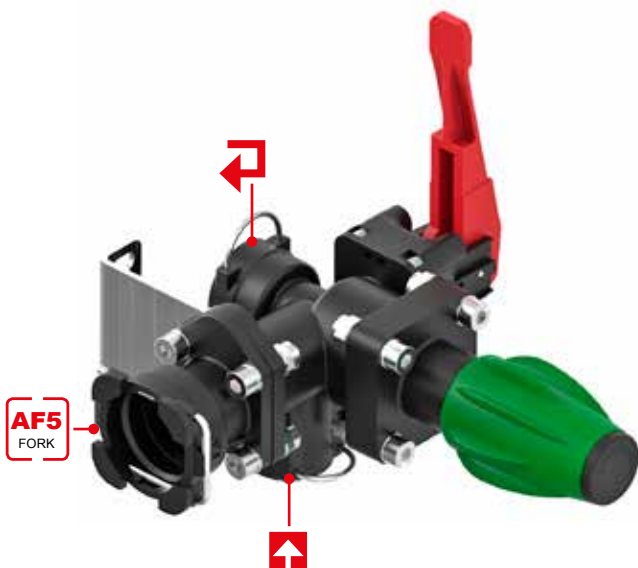

VGM 4-AF

NEW



Part No.	l/1'	bar	°C	Pack
8370035	<60	20		1
8370036	180	10	60	1
8370037		20		1



Obbligatorio ordinare i raccordi separatamente.
Compulsory: fitting to be ordered separately.
Obligatoire: commander les raccords séparément.

IN
Pag. 97

BY-PASS
Pag. 97

AF FORK  **OUT** 

Raccordi d'uscita per valvole sezione barra e valvole di regolazione volumetrica elettrica.
O-ring non incluso nei raccordi.
Da ordinare separatamente

Boom section valves and electric volumetric control valves hosetails.
O-Ring for fittings not included.
To be ordered separately.

Raccords de sortie pour vannes section de rampe et vanne volumétrique électrique.
O-Ring pas compris dans les raccords.
À commander séparément

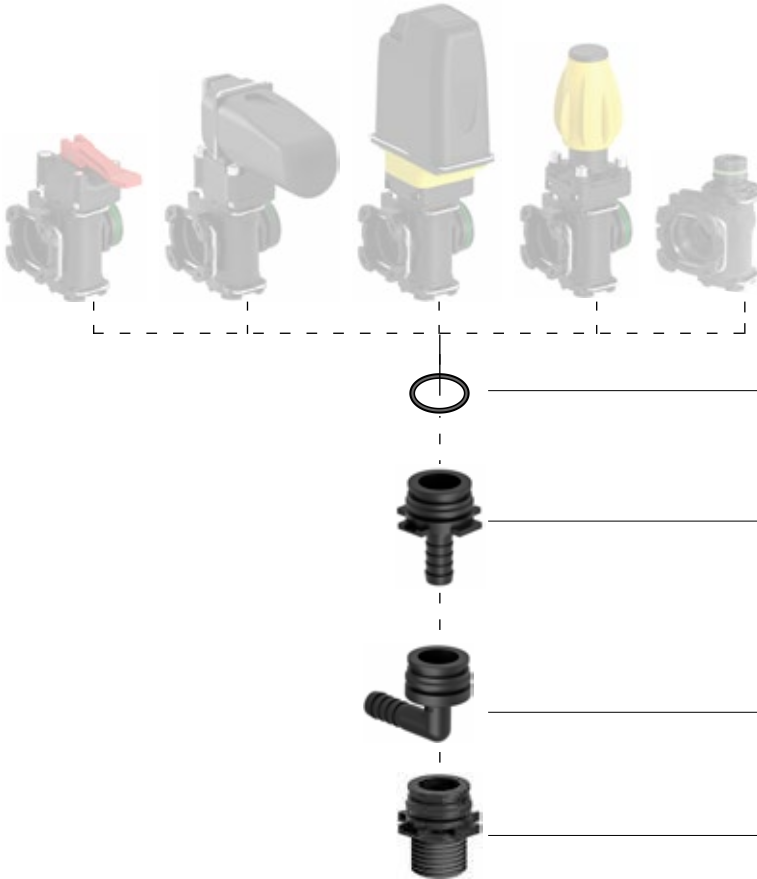

Part No.	Ø mm	Type	Pack	
G00001021	/	OR Viton®	25	
8416301	10	AF3	1	
8416302	13			
8416303	16			
8416304	19			
8416305	25			
8416306	30			
8420301	10	AF3	90°	1
8420302	13			
8420303	16			
8420304	20			
8420305	25			
8426301	G 3/4 M	AF3	1	

AF FORK **FORK** 

NRG series

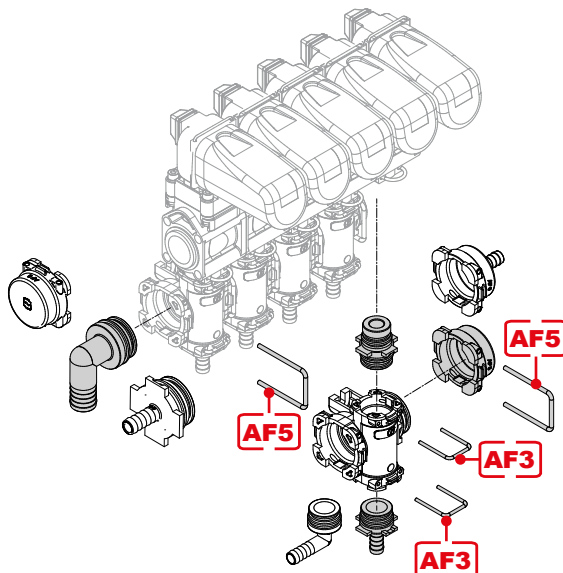

Part No.	AF	Pack
F00000025	3	1
F00000029	5	1



AF
FORK



MOUNTING KIT

NEW

Kit di fissaggio in acciaio inox per valvole attacco a forchetta.

Stainless steel mounting kit for fork coupling valves.

Kit de fixation en acier inoxydable pour vannes avec raccords à fourche

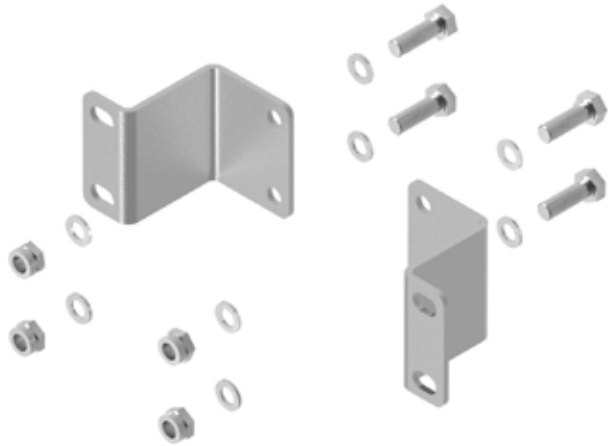

Part No.	Pack
8392087	1

MOUNTING

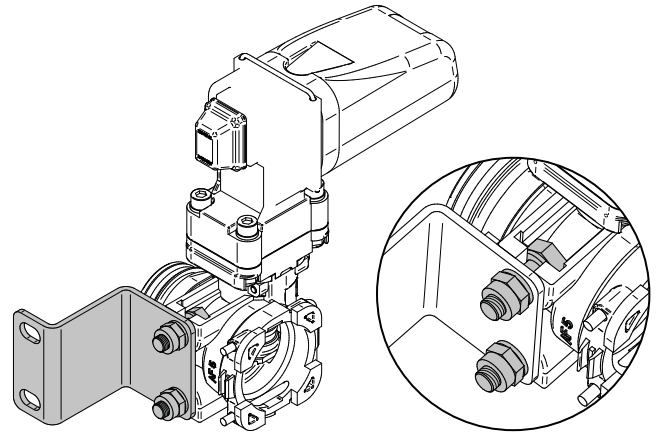

AF
FORK



MANIFOLDS KIT

NEW

Kit collettori compensatori per valvole con attacco a forchetta.

Kit of compensating manifolds for fork coupling valves.

Kit collecteurs compensateurs pour vannes avec raccords à fourche.

Forchetta
Fork
Fourchette

AF3
FORK

G1 M outlet

NEW

Part No. Pack
K99900300 1

Part No. Pack
F00000011 1

Intermediate

Part No. Pack
K99900056 1

Closed

Part No. Pack
K99900055 1

Tappo
Plug
Bouchon

Part No. Pack
T00000017 1

Portagomma
Hosetail
Porte-tuyau

Part No. Ø mm Pack
R00000064 13 1
R00000065 16 1



AF
FORK

FITTINGS OUT / BY-PASS



Raccordi di completamento con attacco a forchetta.
O-ring e forchetta non inclusi nei raccordi.
Da ordinare separatamente

Completion fittings with fork coupling.
O-Ring and fork for fittings not included.
To be ordered separately.

Raccords d'achèvement avec accouplement à fourche.
O-Ring et fourche pas compris dans les raccords.
À commander séparément

Portagomma dritto attacco a forchetta femmina
Straight hosetail with female fork coupling
Raccord droit avec accouplement à fourche femelle



Part No.	AF	Ø mm	L mm	Pack	Fork
8415301		10	48	25	
8415302		13	48	25	
8415303	3	16	48	25	F00000025
8415304		20	54	25	
8415305		25	54	25	
8415501		13	52	25	
8415502		16	52	25	
8415503		20	58	25	
8415504		25	58	25	
8415505	5	30	58	25	F00000029
8415506		32	61	25	
8415507		35	63	25	
8415508		38	69	25	
8415509		40	69	25	

Portagomma dritto attacco a forchetta maschio
Straight hosetail with male fork coupling
Raccord droit avec accouplement à fourche mâle

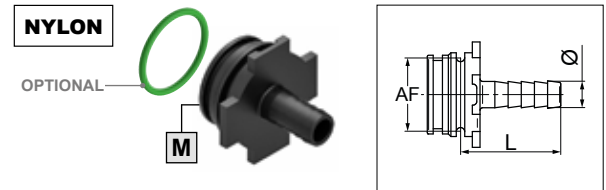

Part No.	AF	Ø mm	L mm	Pack	EPDM	VITON®
					O-ring	O-ring
8416301		10	38	25		
8416302		13	38	25		
8416303	3	16	38	25	G00001020	G00001021
8416304		20	44	25		
8416305		25	44	25		
8416306		30	44	25		
8416501		13	40	25		
8416502		16	40	25		
8416503		20	45	25		
8416504		25	45	25		
8416505	5	30	45	25	G00001277	G00001074
8416506		32	49	25		
8416507		35	51	25		
8416508		38	57	25		
8416509		40	57	25		

Portagomma curvo 90° attacco a forchetta femmina
90° hosetail with female fork coupling
Raccord coudé à 90° avec accouplement à fourche femelle

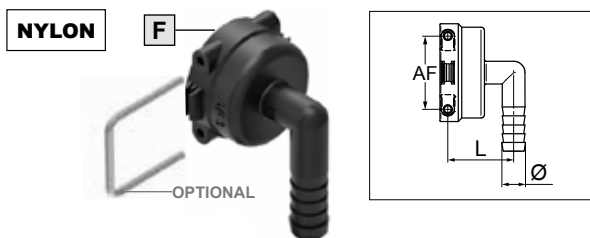

Part No.	AF	Ø mm	L mm	Pack	Fork
8419501		13	38	25	
8419502		16	38	25	
8419503		20	38	25	
8419504		25	38	25	
8419505	5	30	38	25	F00000029
8419506		32	38	25	
8419507		35	38	25	
8419508		38	38	25	
8419509		40	38	25	

Portagomma curvo 90° attacco a forchetta maschio
90° hosetail with male fork coupling
Raccord coudé à 90° avec accouplement à fourche mâle

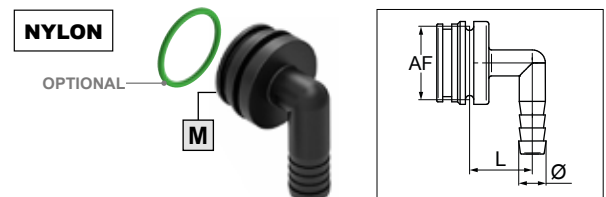

Part No.	AF	Ø mm	L mm	Pack	EPDM	VITON®		
					O-ring	O-ring		
8420301		10	24	25				
8420302		13	24	25				
8420303	3	16	24	25	G00001020	G00001021		
8420304		20	24	25				
8420305		25	24	25				
8420501		13	35	25				
8420502		16	35	25				
8420503		20	35	25				
8420504		25	35	25				
8420505	5	30	35	25	G00001277	G00001074		
8420506		32	35	25				
8420507		35	35	25				
8420508		38	35	25				
8420509		40	35	25				



AF
FORK

FITTINGS OUT / BY-PASS

NEW

Raccordi di completamento con attacco a forchetta.
O-ring e forchetta non inclusi nei raccordi.
Da ordinare separatamente

Completion fittings with fork coupling.
O-Ring and fork for fittings not included.
To be ordered separately.

Raccords d'achèvement avec accouplement à fourche.
O-Ring et fourche pas compris dans les raccords.
À commander séparément

Tappo attacco a forchetta femmina

Female fork coupling plug

Bouchon pour accouplement à fourche femelle

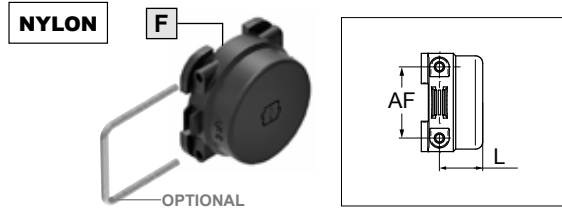

Part No.	AF	L mm	Pack	Fork
8459301	3	18	25	F00000025
8459501	5	21	25	F00000029

Tappo attacco a forchetta maschio

Male fork coupling plug

Bouchon pour accouplement à fourche mâle

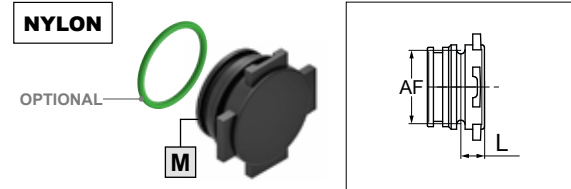

Part No.	AF	L mm	Pack	O-ring EPDM	O-ring VITON®
8460301	3	9	25	G00001020	G00001021
8460501	5	11	25	G00001277	G00001074

Manicotto attacco a forchetta femmina

Female fork coupling plug

Manchon pour accouplement à fourche femelle

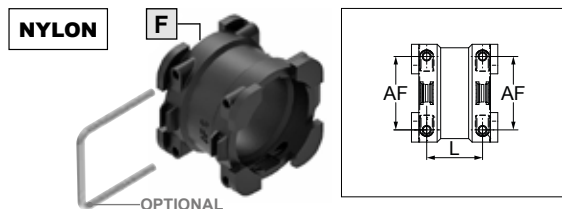

Part No.	AF	L mm	Pack	Fork
8433501	5	32	1	F00000029

Niplo attacco a forchetta maschio

Male fork coupling plug

Nipple pour accouplement à fourche mâle



Part No.	AF	L mm	Pack	O-ring EPDM	O-ring VITON®
8434301	5	1	1	G00001277	G00001074
8434501	5	20	1	G00001277	G00001074

Kit adattatore femmina VGM5-VGME5

Female adapter kit VGM5-VGME5

Kit adapteur femelle VGM5-VGME5



Part No.	AF	L mm	Pack	Fork
F00102037	5	22	1	F00000029

Kit adattatore maschio VGM5-VGME5

Male adapter kit VGM5-VGME5

Kit adapteur male VGM5-VGME5

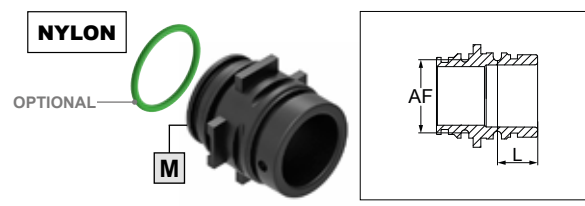

Part No.	AF	L mm	Pack	O-ring EPDM	O-ring VITON®
F00102036	5	22	1	G00001277	G00001074



AF
FORK

FITTINGS OUT / BY-PASS



Raccordi di completamento con attacco a forchetta.
O-ring e forchetta non inclusi nei raccordi.
Da ordinare separatamente

Completion fittings with fork coupling.
O-Ring and fork for fittings not included.
To be ordered separately.

Raccords d'achèvement avec accouplement à fourche.
O-Ring et fourche pas compris dans les raccords.
À commander séparément

Flangia porta manometro
Pressure gauge adapter
Bride pour manomètre



Part No.	AF	L mm	Pack	Fork
F00102039	5	37	1	F00000029

Flangia porta manometro
Pressure gauge adapter
Bride pour manomètre



Part No.	AF	L mm	Pack	EPDM O-ring	VITON® O-ring
F00102038	5	46	1	G00001277	G00001074

Kit adattatore VGE-VGM-VGME-NRG
Adapter kit VGE-VGM-VGME-NRG
Kit adaptateur VGE-VGM-VGME-NRG

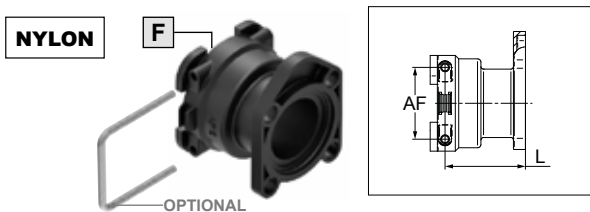

Part No.	AF	Type	L mm	Pack	Fork
F00102028	5	NRG M	47	1	F00000029

Kit adattatore VGE-VGM-VGME-NRG
Adapter kit VGE-VGM-VGME-NRG
Kit adaptateur VGE-VGM-VGME-NRG



Part No.	AF	Type	L mm	Pack	EPDM O-ring	VITON® O-ring
F00102035	5	NRG F	35	1	G00001277	G00001074

Distributore elettrico con valvola volumetrica, filtro, valvola di massima pressione, comando generale e flussometro.

Electric control unit with volumetric regulating valve, filter, main control valve, manual adjustable pressure relief valve and flow-meter.

Groupe de commande électrique avec vanne volumétrique de réglage, filtre, vanne réglable de pression maxi, vanne générale et débitmètre.

Predisposto per dialogare con i computer serie GeoSystem.

Suitable to be connected to GeoSystem computer series.

Adapte pour connection avec ordinateurs GeoSystem.

GSMSTF/DRIVER - PLUS

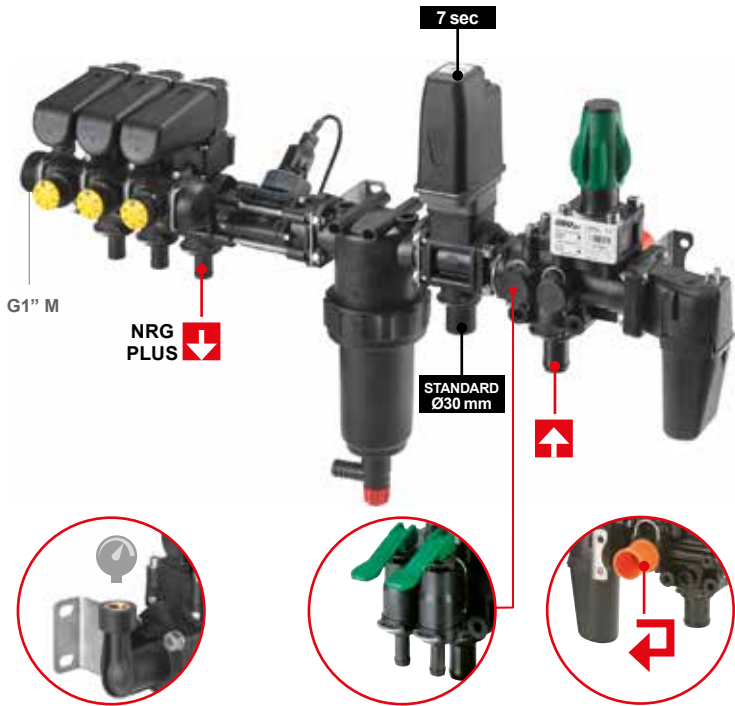

Part No.	Valves	l/1'	bar	°C	V dc	Pack
8376127	3	300	15	60	12	1
8376128	4					1
8376129	5					1
8376131	7					1

Obbligatorio ordinare i raccordi separatamente.
Compulsory: fitting to be ordered separately.
Obligatoire: commander les raccords séparément.

IN Pag. 97 **OUT** Pag. 99 **BY-PASS** Pag. 97

OPTIONALS

Pag. 326	Pag. 55	Pag. 36→40 Pag. 52→53	Pag. 6→35	P/N K00102000 Rubinetti modulari Modular valves Vannes modulaires
----------	---------	--------------------------	-----------	---

GSSTF/DRIVER - PLUS

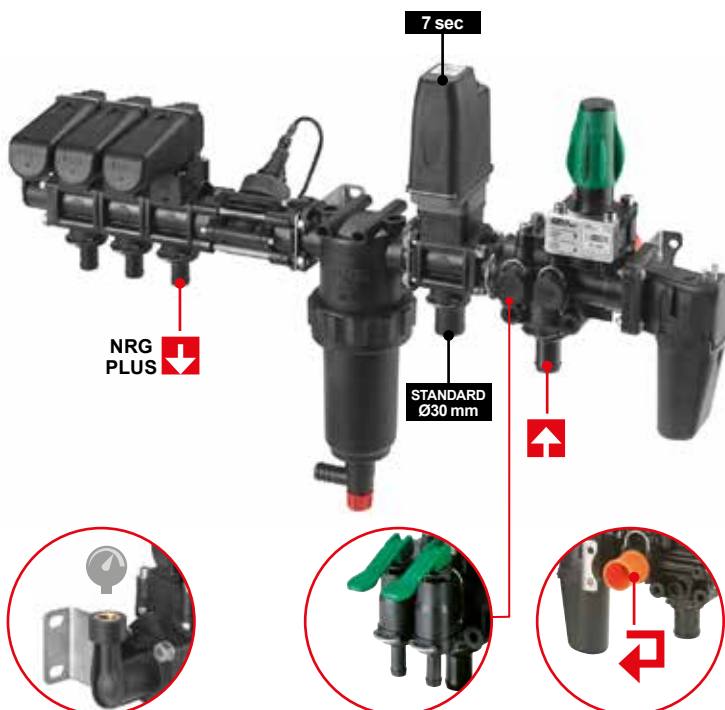

Part No.	Valves	l/1'	bar	°C	V dc	Pack
8376103	3	300	15	60	12	1
8376104	4					1
8376105	5					1
8376126	7					1

Obbligatorio ordinare i raccordi separatamente.
Compulsory: fitting to be ordered separately.
Obligatoire: commander les raccords séparément.

IN Pag. 97 **OUT** Pag. 99 **BY-PASS** Pag. 97

OPTIONALS

Pag. 326	Pag. 55	Pag. 36→40 Pag. 52→53	Pag. 6→35	P/N K00102000 Rubinetti modulari Modular valves Vannes modulaires
----------	---------	--------------------------	-----------	---

Distributore elettrico con valvola volumetrica, filtro, valvola di massima pressione, comando generale e flussometro.

Electric control unit with volumetric regulating valve, filter, main control valve, manual adjustable pressure relief valve and flow-meter.

Groupe de commande électrique avec vanne volumétrique de réglage, filtre, vanne réglable de pression maxi, vanne générale et débitmètre.

Predisposto per dialogare con i computer serie GeoSystem.

Suitable to be connected to GeoSystem computer series.

Adapte pour connection avec ordinateurs GeoSystem.

GSMSTF/DRIVER - 06

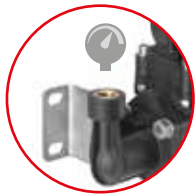
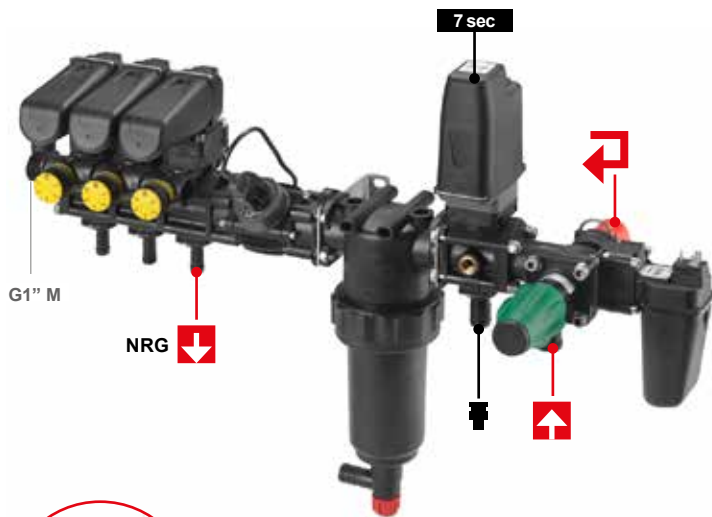

Part No.	Valves	I/1'	bar	Ø mm	°C	V dc	Pack
8376132	3			19			1
8376133	4			25			1
8376134	5	180	15	25	60	12	1
8376144	6			25			1
8376135	7			25			1

Obbligatorio ordinare i raccordi separatamente.
Compulsory: fitting to be ordered separately.
Obligatoire: commander les raccords séparément.



Pag. 97



Pag. 99



Pag. 97

OPTIONALS



Pag. 326



Pag. 55



Pag. 36→40
Pag. 52→53



Pag. 6→35



Pag. 106

GSMF/DRIVER - 06

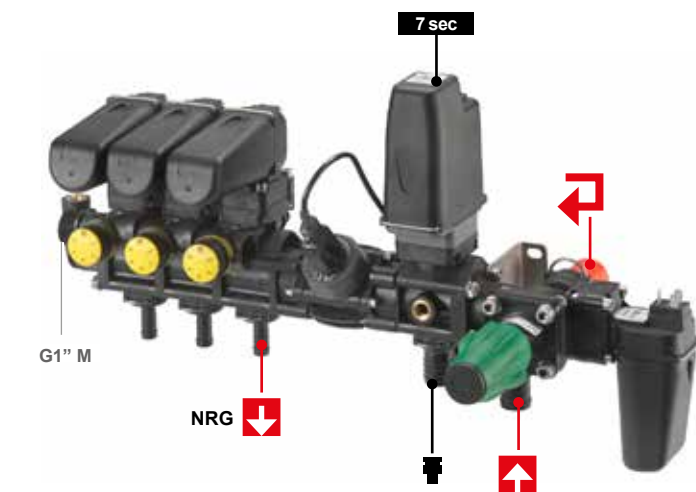
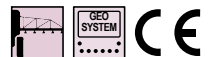

NEW

Part No.	Valves	I/1'	bar	Ø mm	°C	V dc	Pack
8376138	3			25			1
8376136	4			25			1
8376137	5	180	20	25	60	12	1
8376139	7			25			1
8376148	9			25			1

Obbligatorio ordinare i raccordi separatamente.
Compulsory: fitting to be ordered separately.
Obligatoire: commander les raccords séparément.



Pag. 97



Pag. 99



Pag. 97

OPTIONALS



Pag. 326



Pag. 55



Pag. 36→40
Pag. 52→53



Pag. 6→35



Pag. 106

GSSTF/DRIVER - 06



Distributore elettrico con valvola volumetrica, filtro, valvola di massima pressione, comando generale e flussometro.

Electric control unit with volumetric regulating valve, filter, main control valve, manual adjustable pressure relief valve and flow-meter.

Groupe de commande électrique avec vanne volumétrique de réglage, filtre, vanne réglable de pression maxi, vanne générale et débitmètre.

Predisposto per dialogare con i computer serie GeoSystem.

Suitable to be connected to GeoSystem computer series.

Adapte pour connection avec ordinateurs GeoSystem.

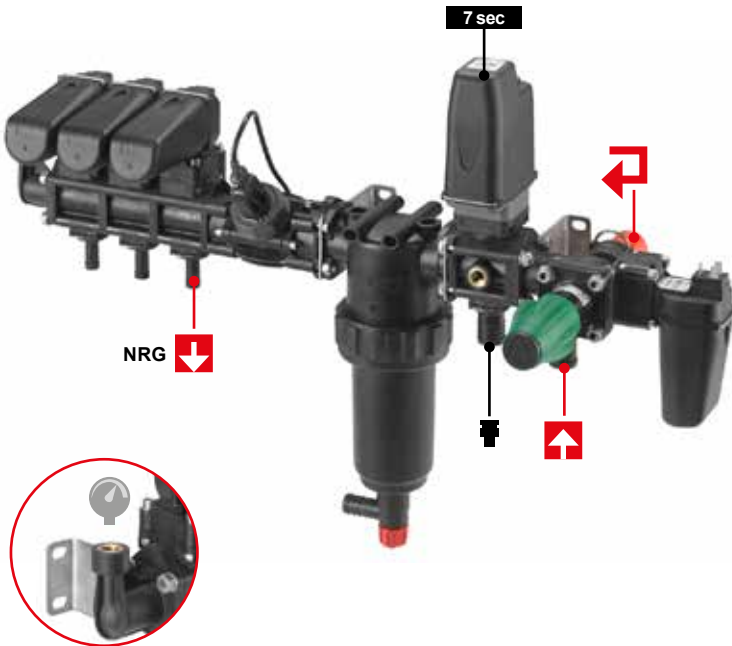

Part No.	Valves	l/l'	bar	Ø mm	°C	V dc	Pack
8376099	3			19			1
8376100	4	180	15	25	60	12	1
8376101	5			25			1
8376102	7			25			1

Obbligatorio ordinare i raccordi separatamente.
Compulsory: fitting to be ordered separately.
Obligatoire: commander les raccords séparément.

IN
↑ Pag. 97

OUT
↓ Pag. 99

BY-PASS
↻ Pag. 97

OPTIONALS

Pag. 326	Pag. 55	Pag. 36→40 Pag. 52→53	Pag. 6→35	Pag. 106

GSF PILOT



Distributore elettrico con valvola volumetrica manuale, valvola regolabile di massima pressione, valvola di scarico, valvole di sezione compensate e flange in ottone.

Predisposto per dialogare con i computer serie GeoSystem.

Electric control unit for orchard sprayers with manual volumetric valve, pressure relief valve, dump valve, metered section valves, and flow-meter and brass flanges.

Suitable to be connected to GeoSystem computer series.

Groupe de commande électrique pour atomiseurs avec vanne volumétrique de réglage, vanne manuelle de pression maxi, vanne de vidange, vannes de section réglables, débitmètre et brides en laiton.

Adapte pour connexion avec ordinateurs GeoSystem.



NEW

Part No.	Valves	Type	I/1'	bar	°C	V dc	Pack
8378034	2	TURBINE FLOW	150	20	60	12	1
8378035	2			40			1
8378056	3			40			1
8378036	4			20			1
8378037	4			40			1
8378038	5	40	1				

OPTIONALS

Pag. 326	Pag. 55	Pag. 36→40 Pag. 52→53	Only **RD	Pag. 6→35 Pag. 106



Part No.	Valves	Type	I/1'	bar	°C	V dc	Pack
8378039	2	ELEMAG FLOW	150	20	60	12	1
8378040	2			40			1
8378041	4			20			1
8378042	4			40			1
8378043	5			40			1

OPTIONALS

Pag. 326	Pag. 55	Pag. 36→40 Pag. 52→53	Only **RD	Pag. 6→35 Pag. 106

STF/DRIVER - PLUS



Distributore elettrico STF/DRIVER-PLUS con valvola volumetrica, filtro, valvola di massima pressione, comando generale e flussometro.

Electric control unit STF/DRIVER-PLUS with volumetric regulating valve, filter, main control valve, manual adjustable pressure relief valve and flow-meter.

Groupe de commande électrique STF/DRIVER-PLUS avec vanne volumétrique de réglage, filtre, vanne réglable de pression maxi, vanne générale et débitmètre.

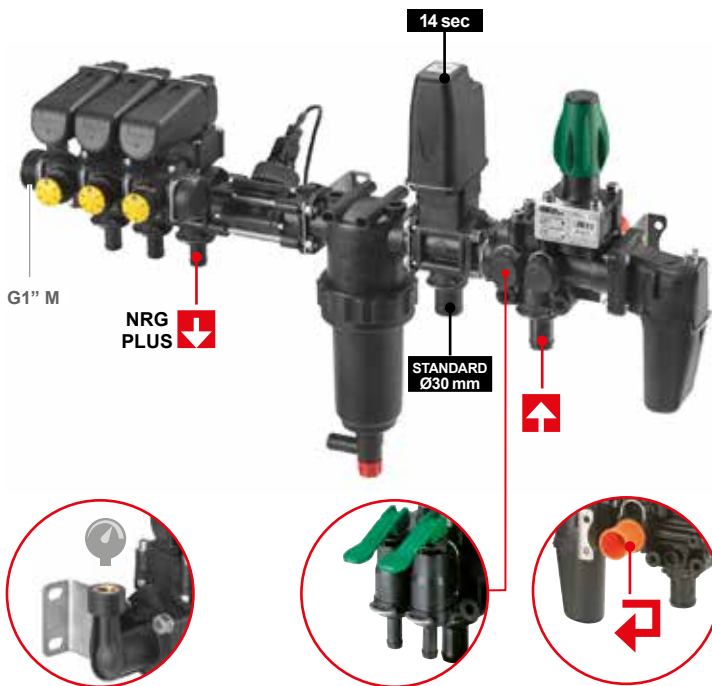

Part No.	Valves	l/1'	bar	°C	V dc	Pack
8376090	3					1
8376091	4	300	15	60	12	1
8376092	5					1
8376130	7					1

Obbligatorio ordinare i raccordi separatamente.
Compulsory: fitting to be ordered separately.
Obligatoire: commander les raccords séparément.

IN ↑ Pag. 97 **OUT** ↓ Pag. 99 **BY-PASS** ↻ Pag. 97

OPTIONALS

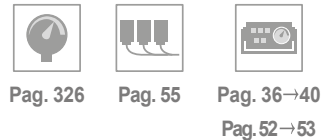

STF/DRIVER - 06

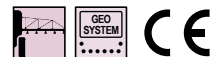

Distributore elettrico STF/DRIVER-06 con valvola volumetrica, filtro, valvola di massima pressione, comando generale e flussometro.

Electric control unit STF/DRIVER-06 with volumetric regulating valve, filter, main control valve, manual adjustable pressure relief valve and flow-meter.

Groupe de commande électrique STF/DRIVER-06 avec vanne volumétrique de réglage, filtre, vanne réglable de pression maxi, vanne générale et débitmètre.

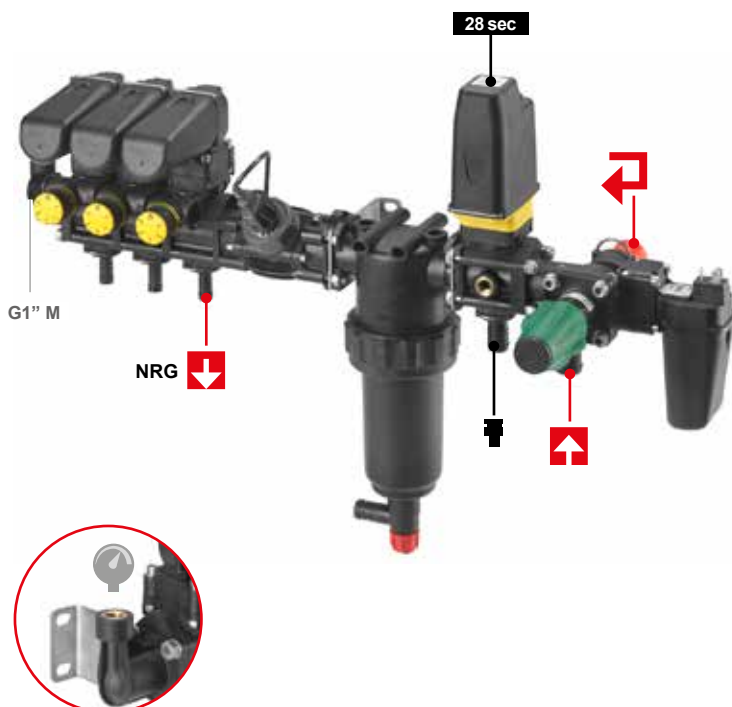

Part No.	Valves	l/1'	bar	Ø mm	°C	V dc	Pack
8376083	3			19			1
8376084	4	180	15	25	60	12	1
8376085	5			25			1
8376123	7			25			1

Obbligatorio ordinare i raccordi separatamente.
Compulsory: fitting to be ordered separately.
Obligatoire: commander les raccords séparément.

IN ↑ Pag. 97 **OUT** ↓ Pag. 99 **BY-PASS** ↻ Pag. 97

OPTIONALS

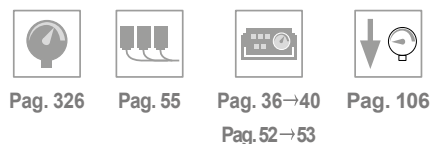

ST/DRIVER - PLUS



Distributore elettrico ST/DRIVER-PLUS con valvola volumetrica, filtro, valvola di massima pressione e comando generale.

Electric control unit ST/DRIVER-PLUS with volumetric regulating valve, filter, main control valve with manual adjustable pressure relief valve.

Groupe de commande électrique ST/DRIVER-PLUS avec vanne volumétrique de réglage, filtre, vanne réglable de pression maxi.

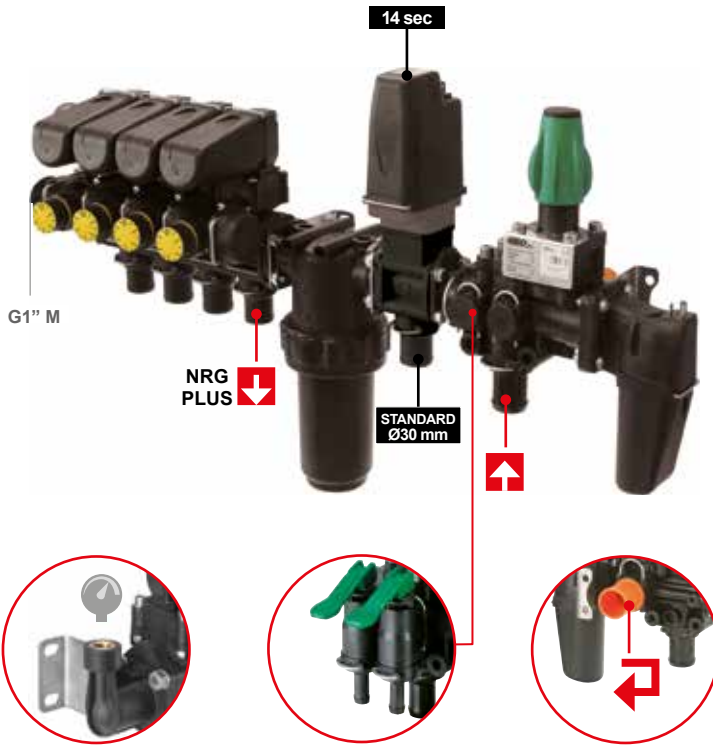

Part No.	Valves	l/1'	bar	°C	V dc	Pack
8376093	3					1
8376094	4	300	15	60	12	1
8376095	5					1

Obbligatorio ordinare i raccordi separatamente.
Compulsory: fitting to be ordered separately.
Obligatoire: commander les raccords séparément.

IN
↑ Pag. 97

OUT
↓ Pag. 99

BY-PASS
↻ Pag. 97

OPTIONALS



Pag. 326



Pag. 55



Pag. 36→40
Pag. 52→53

P/N K00102000
Rubinetti modulari
Modular valves
Vannes modulaires

ST/DRIVER



Distributore elettrico ST/DRIVER con valvola volumetrica, filtro, valvola di massima pressione e comando generale.

Electric control unit ST/DRIVER with volumetric regulating valve, filter, main control valve with manual adjustable pressure relief valve.

Groupe de commande électrique ST/DRIVER avec vanne volumétrique de réglage, filtre, vanne réglable de pression maxi.

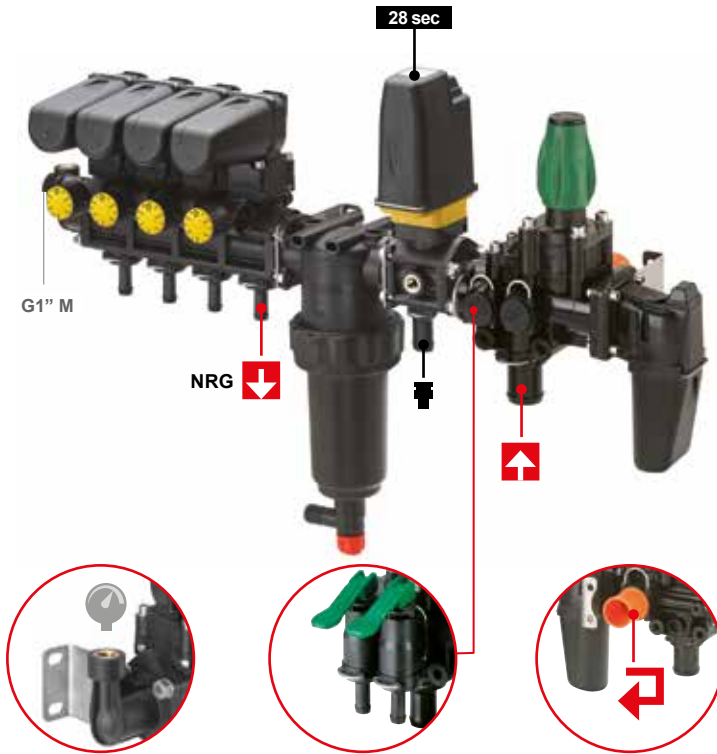

Part No.	Valves	I/I'	bar	Ø mm	°C	V dc	Pack
8376063	3			19			1
8376020	4	210	15	25	60	12	1
8376021	5			25			1
8376022	6			25			

Obbligatorio ordinare i raccordi separatamente.
Compulsory: fitting to be ordered separately.
Obligatoire: commander les raccords séparément.

IN
↑ Pag. 97

OUT
↓ Pag. 99

BY-PASS
↻ Pag. 97

Complete control unit: Pag. 126

OPTIONALS



Pag. 326



Pag. 55



Pag. 36→40



Pag. 106

Pag. 52 → 53

P/N K00102000
Rubinetti modulari
Modular valves
Vannes modulaires

ST/DRIVER - 06



Distributore elettrico serie ST/DRIVER-06 con valvola volumetrica, filtro, valvola di massima pressione e comando generale.

Electric control unit ST/DRIVER-06 with volumetric regulating valve, filter, main control valve with manual adjustable pressure relief valve.

Groupe de commande électrique ST/DRIVER-06 avec vanne volumétrique de réglage, filtre, vanne réglable de pression maxi.



Complete control unit: Pag. 126

Part No.	Valves	I/1'	bar	Ø mm	°C	V dc	Pack
8376087	2			19			1
8376088	3			19			1
8376076	4	180	15	25	60	12	1
8376077	5			25			1
8376078	6			25			1
8376125	7			25			1

Obbligatorio ordinare i raccordi separatamente.
Compulsory: fitting to be ordered separately.
Obligatoire: commander les raccords séparément.

IN
Pag. 97

OUT
Pag. 99

BY-PASS
Pag. 97

OPTIONALS



Pag. 326



Pag. 55



Pag. 36→40
Pag. 52→53

DRIVER - PLUS



Distributore elettrico DRIVER PLUS con valvola volumetrica, valvola regolabile di massima pressione e comando generale.

Electric control unit DRIVER PLUS with volumetric regulating valve, manual adjustable pressure relief valve and main control valve.

Groupe de commande électrique DRIVER PLUS avec vanne volumétrique de réglage, vanne manuelle réglable de pression maxi et vanne générale.

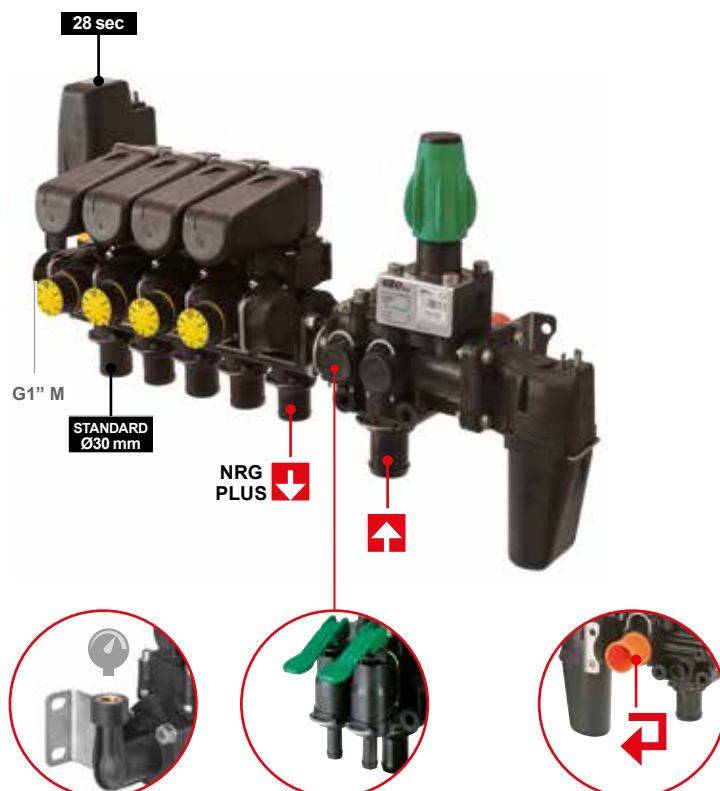

Part No.	Valves	I/1'	bar	°C	V dc	Pack
8376096	3					1
8376097	4	300	20	60	12	1
8376098	5					1

Obbligatorio ordinare i raccordi separatamente.
Compulsory: fitting to be ordered separately.
Obligatoire: commander les raccords séparément.

IN
Pag. 97

OUT
Pag. 99

BY-PASS
Pag. 97

OPTIONALS



Pag. 326



Pag. 55



Pag. 36→40
Pag. 52→53



DRIVER



Distributore elettrico DRIVER con valvola volumetrica, valvola regolabile di massima pressione e comando generale.

Electric control unit DRIVER with volumetric regulating valve, manual adjustable pressure relief valve and main control valve.

Groupe de commande électrique DRIVER avec vanne volumétrique de réglage, vanne manuelle réglable de pression maxi et vanne générale.

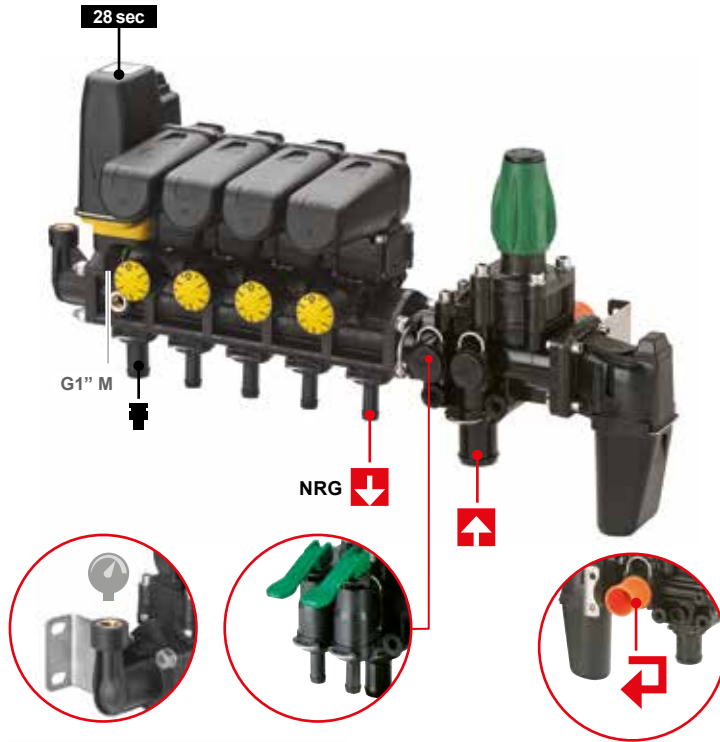

Complete control unit: Pag. 126

Part No.	Valves	l/1'	bar	Ø mm	°C	V dc	Pack
8376038	3	210	20	19	60	12	1
8376017	4			25			1
8376018	5			25			1
8376019	6			25			1

Obbligatorio ordinare i raccordi separatamente.
Compulsory: fitting to be ordered separately.
Obligatoire: commander les raccords séparément.

IN ↑ Pag. 97 **OUT** ↓ Pag. 99 **BY-PASS** ↻ Pag. 97

OPTIONALS

Pag. 326
 Pag. 55
 Pag. 36→40
 Pag. 106
 Pag. 52→53

P/N K00102000
Rubinetti modulari
Modular valves
Vannes modulaires

DRIVER - 06



Distributore elettrico serie DRIVER-06 con valvola volumetrica, valvola regolabile di massima pressione e comando generale.

Electric control unit DRIVER-06 with volumetric regulating valve, manual adjustable pressure relief valve and main control valve.

Groupe de commande électrique DRIVER-06 avec vanne volumétrique de réglage, vanne manuelle réglable de pression maxi et vanne générale.

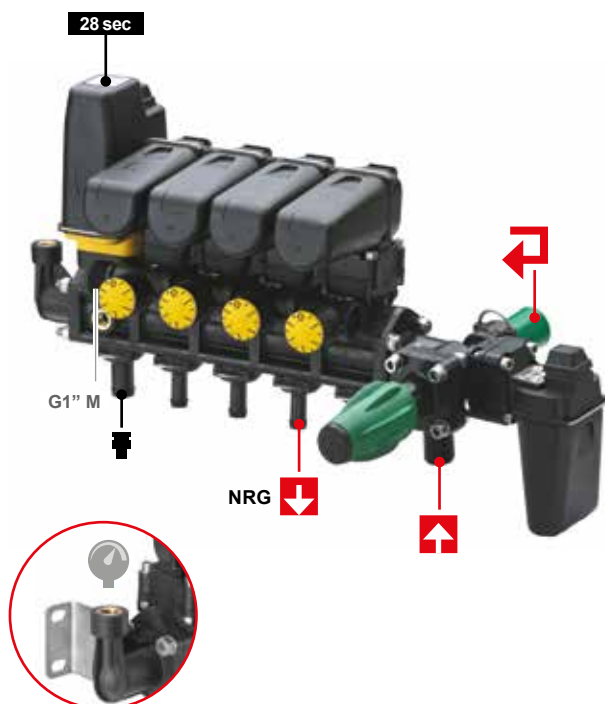

Complete control unit: Pag. 126

Part No.	Valves	l/1'	bar	Ø mm	°C	V dc	Pack
8376086	2	180	20	19	60	12	1
8376079	3			19			1
8376080	4			25			1
8376081	5			25			1
8376082	6			25			1

OPTIONALS

Pag. 326
 Pag. 55
 Pag. 36→40
 Pag. 106
 Pag. 52→53

MIDI DRIVER 06



Distributore Midi Driver 06 a valvole compensate manuali modulari, con valvola di comando VGME4 ad azionamento elettrico e valvola regolabile di massima pressione.
I singoli rubinetti sono modulari.

Midi Driver 06 control unit with metered modular manual valves, electric VGME4 main valve and adjustable pressure relief valve.

Distributeur Midi Driver 06 avec vannes modulaires et manuelles à retour réglable, vanne générale électrique VGME4 et vanne réglable de pression maxi.

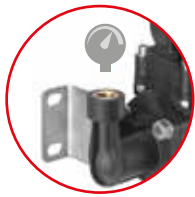
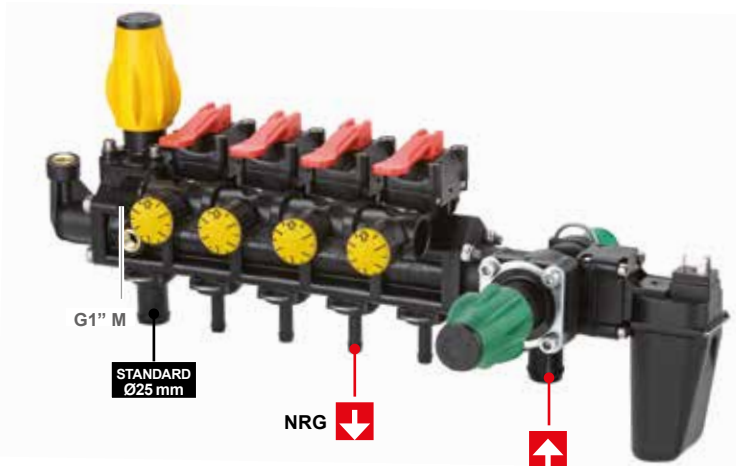

Part No.	Valves	l/1'	bar	°C	V dc	Pack
8376089	2					1
8376064	3					1
8376065	4	180	20	60	12	1
8376066	5					1
8376067	6					1

Obbligatorio ordinare i raccordi separatamente.
Compulsory: fitting to be ordered separately.
Obligatoire: commander les raccords séparément.

IN
Pag. 97

OUT
Pag. 99

BY-PASS
Pag. 97

OPTIONALS



Pag. 326



Pag. 55



Pag. 36→40
Pag. 52→53

BABY DRIVER 06



Distributore Baby Driver 06 a valvole manuali modulari ON/OFF, con valvola di comando VGME4 ad azionamento elettrico e valvola regolabile di massima pressione.
I singoli rubinetti sono modulari.

Baby Driver 06 control unit with ON/OFF modular manual valves, electric VGME4 main valve and adjustable pressure relief valve.

Distributeur Baby Driver 06 avec vannes modulaires manuelles ON/OFF, vanne générale électrique VGME4 et vanne réglable de pression maxi.

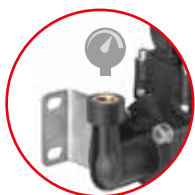
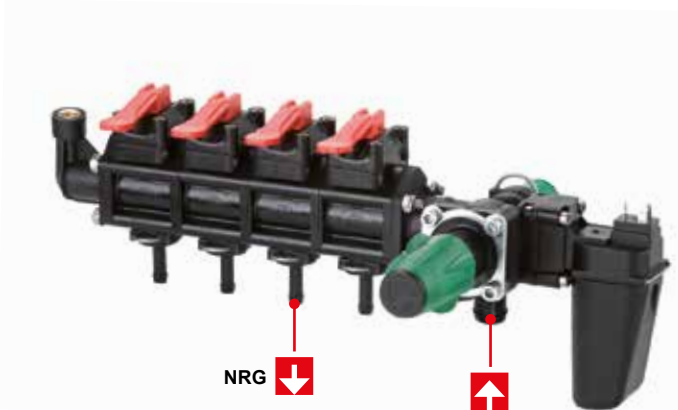

Part No.	Valves	l/1'	bar	°C	V dc	Pack
8374043	2					1
8374029	3					1
8374030	4	180	20	60	12	1
8374031	5					1
8374032	6					1

Obbligatorio ordinare i raccordi separatamente.
Compulsory: fitting to be ordered separately.
Obligatoire: commander les raccords séparément.

IN
Pag. 97

OUT
Pag. 99

BY-PASS
Pag. 97

OPTIONALS



Pag. 326



Pag. 55



Pag. 36→40
Pag. 52→53

PILOT 1



Distributore elettrico con valvola volumetrica manuale, valvola regolabile di massima pressione, valvola di scarico, valvole di sezione compensate e flange in ottone.

Electric control unit for orchard sprayers with manual volumetric valve, pressure relief valve, dump valve, metered section valves and brass flanges.

Groupe de commande électrique pour atomiseurs avec vanne volumétrique de réglage, vanne manuelle de pression maxi, vanne de vidange, vannes de section réglables et brides en laiton.



Part No.	Valves	l/1'	bar	°C	V dc	A mm	Pack
8378003	2		20			336	1
8378004	2	150	40	60	12	336	1
8378005	4		20			450	1
8378006	4		40			450	1

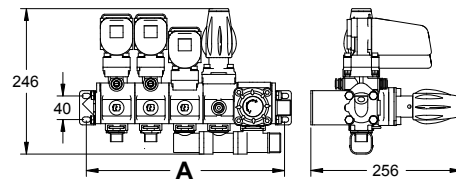

OPTIONALS



Pag. 326



Pag. 55



Pag. 37; 40
Pag. 52-53

Only
**RD

PILOT 2



Distributore elettrico con valvola volumetrica elettrica, valvola regolabile di massima pressione, valvola di scarico, valvole di sezione compensate e flange in ottone.

Electric control unit for orchard sprayers with electric volumetric valve, pressure relief valve, dump valve, metered section valves and brass flanges.

Groupe de commande électrique pour atomiseurs avec vanne volumétrique de réglage, vanne manuelle de pression maxi, vanne de vidange, vannes de section réglables et brides en laiton.



Part No.	Valves	l/1'	bar	°C	V dc	A mm	Pack
8378007	2		20			336	1
8378008	2		40			336	1
8378009	4	150	20	60	12	450	1
8378010	4		40			450	1
8378026	5		40			450	1

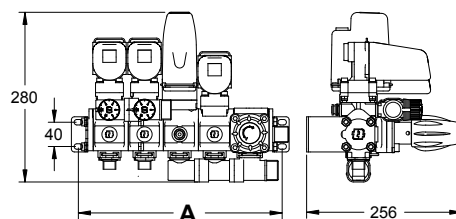

OPTIONALS



Pag. 326



Pag. 55



Pag. 37; 40
Pag. 52-53

Only
**RD

PILOT



Distributore elettrico con valvola regolabile di massima pressione, valvola di scarico, valvole di sezione compensate, filtro e flange in ottone.

Electric control unit for orchard sprayers with pressure relief valve, dump valve, metered section valves, filter and brass flanges.

Groupe de commande électrique pour atomiseurs avec vanne manuelle de pression maxi, vanne de vidange, vannes de section réglables, filtre et brides en laiton.

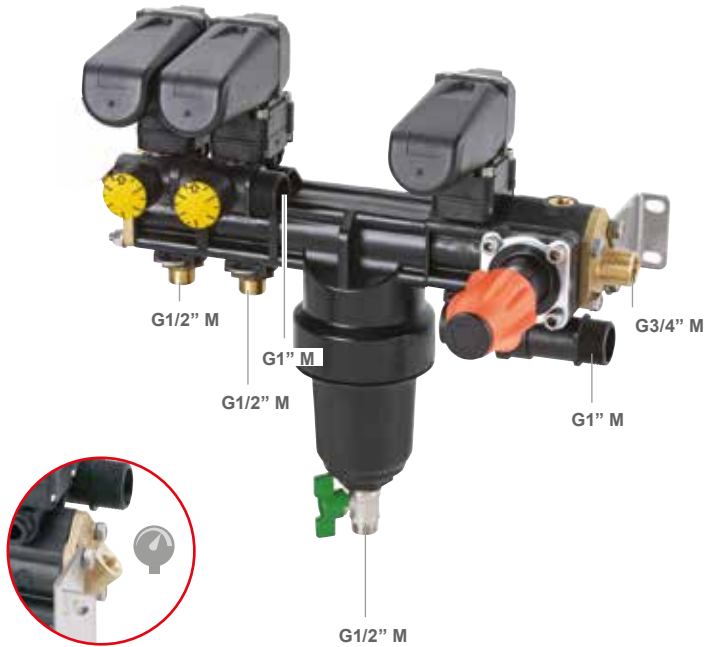

Part No.	Valves	l/1'	bar	°C	V dc	Pack
8378044	2	150	40	60	12	1

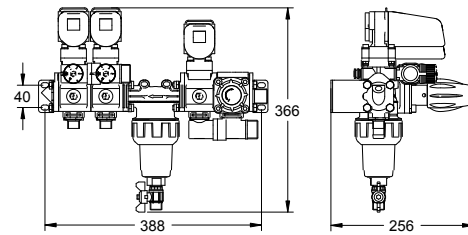

OPTIONALS



Pag. 326



Pag. 55



Pag. 37; 40
Pag. 52-53

Only
**RD

PILOT



Distributore elettrico con valvola volumetrica elettrica, valvola regolabile di massima pressione, valvola di scarico, valvole di sezione compensate, filtro e flange in ottone.

Electric control unit for orchard sprayers with electric volumetric valve, pressure relief valve, dump valve, metered section valves, filter and brass flanges.

Groupe de commande électrique pour atomiseurs avec vanne volumétrique de réglage, vanne manuelle de pression maxi, vanne de vidange, vannes de section réglables, filtre et brides en laiton.



Part No.	Valves	l/1'	bar	°C	V dc	Pack
8378045	2	150	40	60	12	1

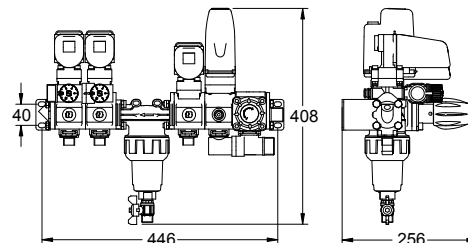

OPTIONALS



Pag. 326



Pag. 55



Pag. 37; 40
Pag. 52-53

Only
**RD

PILOT



Gruppo di comando elettrico proporzionale a 2 vie. Completo di: scatola di comando e cablaggi.

Composizione del kit:

- Gruppo di comando;
- Scatola di comando;
- Cavo collegamento.

2-way Electric control unit with control panel and connecting cables.

Kit composed of:

- Control unit;
- Control box;
- Connecting cable

Groupe de commande proportionnel électrique à 2 voies avec boîtier de commande et câble de branchement.

Composition du kit:

- Groupe de commande
- Control panel;
- Connecting cable



Part No.	Valves	I/1'	bar	°C	V dc	Pack
8378C0054	2	150	40	60	12	1



Part No.	Valves	I/1'	bar	°C	V dc	Pack
8378C0056	2	150	40	60	12	1

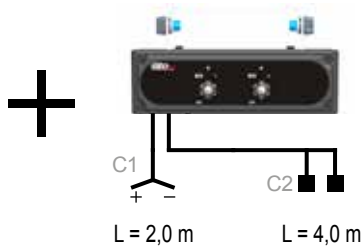

MY18



Gruppo per atomizzatore 2 vie a pressione costante, composto da 2 elettrovalvole a solenoide e valvola manuale di regolazione pressione.

Uscita: G1/2" - Ingresso: 3/4"

Ideale per applicazioni su atomizzatori e gruppi irroranti.

2-way Control unit for orchard sprayers at constant pressure with 2 solenoid valves and pressure relief manual valve.

1/2" BSP outlet and 3/4" BSP inlet

Perfect for applications on orchard sprayers and spraying machines.

Groupe de commande à 2 voies et pression constante pour atomiseur, composé par 2 vannes électriques à solénoïde et vanne manuelle de pression maxi.

Sortie : 1/2" BSP - Entrée: 3/4" BSP

Indiquée pour applications sur atomiseurs.

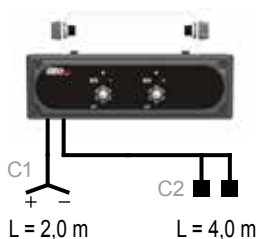

Part No.	Valves	l/1'	bar	°C	V dc	Pack
8378C0053	2	150	40	60	12	1



Comando ORION - ALFA per atomizzatori.

- pressione di esercizio max 60 bar
- portata max 180 l/min
- sfere selettive in acciaio inox
- corpo in ottone per il modello ORION,
- ottone e alluminio per il modello ALFA.

ORION – ALFA control unit for orchard sprayers.

- max working pressure 60 bar
- max flow rate 180 l/min
- stainless steel selecting balls
- brass body for the ORION version, - brass and anodic aluminium for the ALFA version.

Vanne de commande ORION – ALFA pour atomiseurs.

- pression maxi d'usage 60 bar
- débit maxi 180 l/min
- sphères de sélection en acier inox
- corps en laiton pour la version ORION, - en laiton et aluminium anodisé pour la version ALFA.

ORION



Part No.	l/1'	bar	°C	Pack
8378011		40		1
8378012	180	50	60	1
8378013		60		1

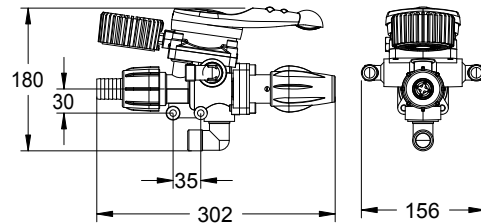

ALFA



Part No.	l/1'	bar	°C	Pack
8378014		40		1
8378015	180	50	60	1
8378016		60		1

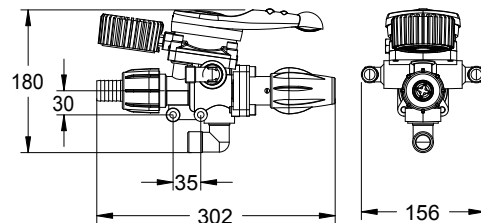

BASIC 217

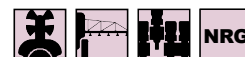

Distributore manuale con rubinetti modulari compensati e valvola di massima pressione.

Modular valve manual control unit with metered by-pass manifold and maximum pressure valve.

Distributeur manuel ON/OFF à vannes modulaires de retour réglable avec vanne volumétrique de réglage.



Part No.	Valves	l/1'	bar	°C	Pack
8378049	2				1
8378050	4	120	40	60	1
NEW 8378055	5				1

OPTIONALS



Pag. 326



KIT DRIVER - 06



Gruppo di comando elettrico proporzionale a 5 vie.
Completo di: scatola di comando, cablaggi e raccordi.

Composizione del kit:

- Gruppo di comando;
- Scatola di comando;
- Cablaggi;
- Raccordi IN, OUT e BY-PASS.

5-way Electric control unit with control panel,
connecting cables and fittings.

Kit composed of:

- Control unit;
- Control panel;
- Connecting cables;
- Fittings IN, OUT and BY-PASS.

Groupe de commande proportionnel électrique
à 5 voies avec boîtier de commande, câble de
branchement et raccords.

Composition du kit:

- Groupe de commande;
- Boîtier de commande;
- Câble de branchement;
- Raccords IN, OUT et BY-PASS.



Part No.	Valves	I/1'	bar	°C	V dc	Pack
8376C0136	5	150	20	60	12	1

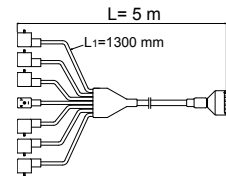
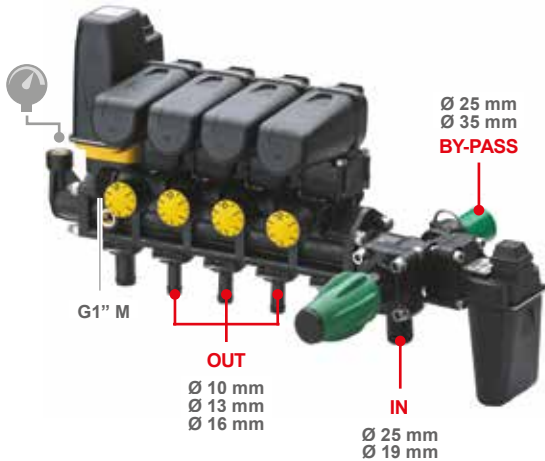

OPTIONALS



Pag. 326

KIT DRIVER - 06



Gruppo di comando elettrico proporzionale a 3/5 vie.
Completo di: scatola di comando, manometro,
cablaggi, raccordi e spina alimentazione
accendisigari.

Composizione del kit:

- Gruppo di comando;
- Scatola di comando;
- Manometro;
- Cablaggi;
- Raccordi IN, OUT e BY-PASS;
- Spina alimentazione accendisigari.

3/5-way Electric control unit with control panel,
pressure gauge, connecting cables, fittings and
cigarette lighter power plug.

Kit composed of:

- Control unit;
- Control panel;
- Pressure gauge;
- Connecting cables;
- Fittings IN, OUT and BY-PASS;
- Cigarette lighter power plug.

Groupe de commande proportionnel électrique à
3/5 voies avec boîtier de commande, manomètre,
câble de branchement, raccords et fiche
alimentation allume-cigare

Composition du kit:

- Groupe de commande
- Boîtier de commande;
- Manomètre;
- Câble de branchement;
- Raccords IN, OUT et BY-PASS;
- Fiche alimentation allume-cigare.



Part No.	Valves	I/1'	bar	°C	V dc	Pack
8376C0040	3	150	20	60	12	1
8376C0041	5	150	20	60	12	1

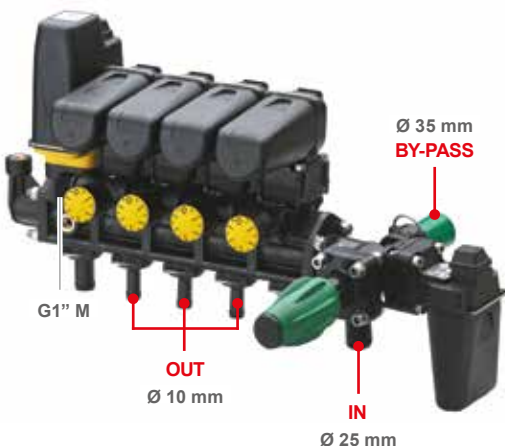

Isometric pressure gauge included

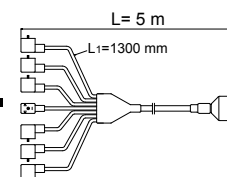

Cigarette lighter power plug



Distributore a valvole modulari manuali compensate con valvola di comando generale ON/OFF, valvola regolatrice di massima pressione a membrana, valvola regolatrice volumetrica e dispositivo di risucchio antigocce. Indicato per chi desidera distribuire in modo semplice ed affidabile la giusta dose di prodotto, proporzionalmente ai giri del motore (RPM) nell'ambito della stessa marcia.

Manual control unit with metered modular valves, main ON/OFF valve, diaphragm pressure relief adjustable valve, volumetric control valve and anti-drip back suction device. Suitable for an accurate distribution of chemicals proportionally to the engine r.p.m. (RPM) with same gear.

Distributeur avec vannes manuelles, modulaires, à retour réglable, vanne générale ON/OFF, vanne réglable de pression maxi à membrane, vanne de régulation volumétrique et dispositif anti-goutte de retour. Indiqué pour une distribution du produit simple et proportionnelle au nombre de tours du moteur (RPM) sans changer de vitesse.

Per completare il comando è necessario scegliere i portagomma di entrata, uscita e by-pass.

When ordering specify diameter of inlet, outlet and by-pass hoses/tails you need.

Préciser à la commande les diamètres des raccords d'entrée, sortie et retour.

ST/BASIC 206

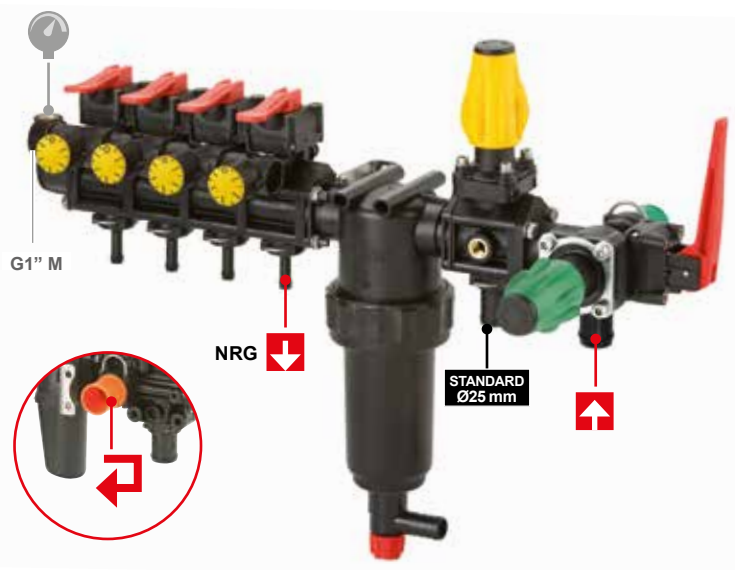
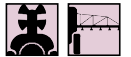

Complete control unit: Pag. 127

Part No.	Valves	l/1'	bar	°C	Pack
8376107	2				1
8376072	3				1
8376073	4	180	15	60	1
8376074	5				1
8376075	6				1
8376141	7				1

Obbligatorio ordinare i raccordi separatamente.
Compulsory: fitting to be ordered separately.
Obligatoire: commander les raccords séparément.

IN
Pag. 97

OUT
Pag. 99

BY-PASS
Pag. 97

OPTIONALS

Pag. 326

BASIC 206

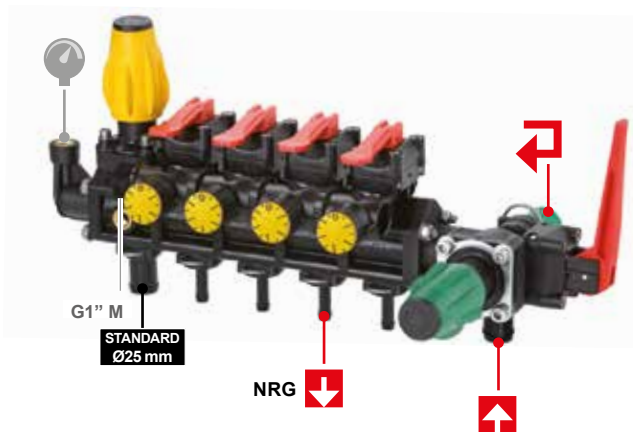

Complete control unit: Pag. 127

Part No.	Valves	l/1'	bar	°C	Pack
8376106	2				1
8376068	3				1
8376069	4	180	20	60	1
8376070	5				1
8376071	6				1
8376142	7				1

Obbligatorio ordinare i raccordi separatamente.
Compulsory: fitting to be ordered separately.
Obligatoire: commander les raccords séparément.

IN
Pag. 97

OUT
Pag. 99

BY-PASS
Pag. 97

OPTIONALS

Pag. 326

ST/START 06

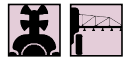

Distributore a valvole modulari manuali con valvola di comando generale ON/OFF, valvola regolatrice di massima pressione a membrana e dispositivo di risucchio antigoccia. Disponibile nelle versioni con e senza filtro.

Manual control unit with modular valves, main ON/OFF valve, diaphragm pressure relief adjustable valve and anti-drip back suction device. Available with or without filter.

Distributeur avec vannes modulaires, vanne générale ON/OFF, vanne réglable de pression maxi à membrane, dispositif anti-goutte de retour. Disponible avec ou sans filtre.

Per completare il comando è necessario scegliere i porta-gomma di entrata, uscita e by-pass.

When ordering specify diameter of inlet, outlet and by-pass hoses you need.

Préciser à la commande les diamètres des raccords d'entrée, sortie et retour souhaité.

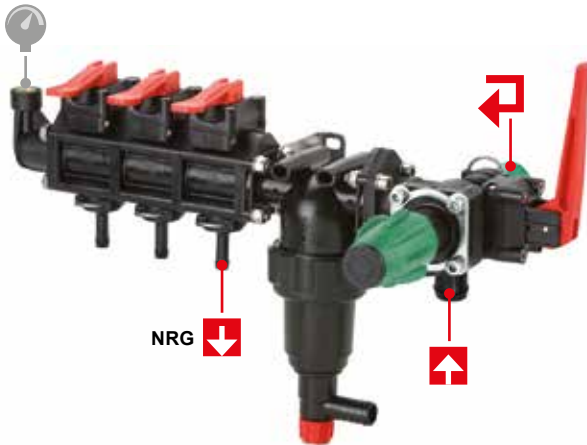

▶ Complete control unit: Pag. 128

OPTIONALS



Pag. 326

Part No.	Valves	I/1'	bar	°C	Pack
8374038	2				1
8374039	3				1
8374040	4	180	20	60	1
8374041	5				1
8374042	6				1
8374053	7				1

Obbligatorio ordinare i raccordi separatamente.
Compulsory: fitting to be ordered separately.
Obligatoire: commander les raccords séparément.



Pag. 97



Pag. 99

BY-PASS

Pag. 97

START 06

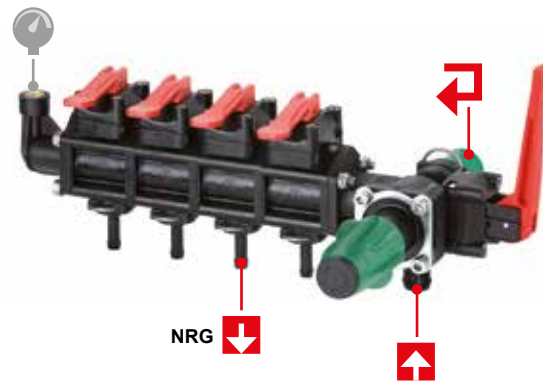

▶ Complete control unit: Pag. 128

OPTIONALS



Pag. 326

Part No.	Valves	I/1'	bar	°C	Pack
8374033	2				1
8374034	3				1
8374035	4	180	20	60	1
8374036	5				1
8374037	6				1
8374054	7				1

Obbligatorio ordinare i raccordi separatamente.
Compulsory: fitting to be ordered separately.
Obligatoire: commander les raccords séparément.



Pag. 97



Pag. 99

BY-PASS

Pag. 97

START 08

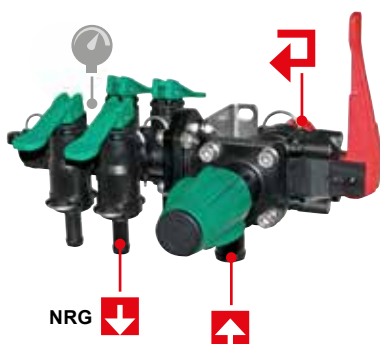

▶ Complete control unit: Pag. 128

OPTIONALS



Pag. 326

Part No.	Valves	I/1'	bar	°C	Pack
8374048	2				1
8374049	3				1
8374050	4	180	20	60	1
8374051	5				1
8374052	6				1

Obbligatorio ordinare i raccordi separatamente.
Compulsory: fitting to be ordered separately.
Obligatoire: commander les raccords séparément.



Pag. 97



Pag. 99

BY-PASS

Pag. 97

ECOSTAR



Gruppi di comando a pressione costante.
Per completare il comando è necessario scegliere i porta-gomma di entrata, uscita e by-pass.

Constant pressure control units.
When ordering specify diameter of outlet hoses you need.

Groupes de commande à pression constante.
Préciser à la commande les diamètres des raccords de retour demandé.

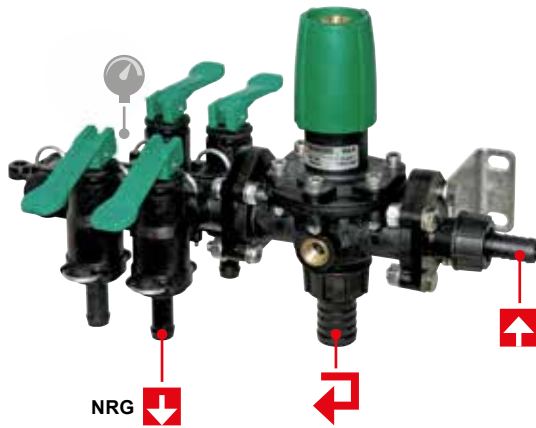

NRG

OPTIONALS



Pag. 326

Complete control unit: Pag. 128

Part No.	Valves	I/1'	bar	°C	Pack
8374044	2				1
8374045	3	180	20	60	1
8374046	4				1
8374047	5				1

Obbligatorio ordinare i raccordi separatamente.
Compulsory: fitting to be ordered separately.
Obligatoire: commander les raccords séparément.



Pag. 99



P/N 8002200	Ø 13 mm	
P/N 8002201	Ø 15 mm	
P/N 8002202	Ø 19 mm	
P/N 8012200	Ø 13 mm	
P/N 8012201	Ø 15 mm	
P/N 8012203	Ø 19 mm	

BY-PASS



P/N 8002252	Ø 19 mm	
P/N 8002253	Ø 22 mm	
P/N 8002254	Ø 25 mm	

NRG



Gruppo elettrovalvole NRG, con ritorni registrabili, e valvola volumetrica regolabile elettricamente.

Electric control unit NRG with by-pass manifold and volumetric regulating valve.

Groupe de vannes électriques NRG avec compensateurs de pression et vanne volumétrique de réglage.

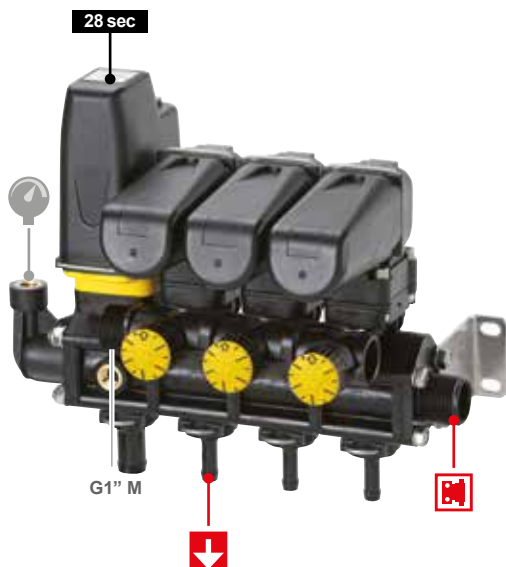

G1" M

OPTIONALS



Pag. 326



Pag. 55



Pag. 36→40
Pag. 52→53



Pag. 106

Part No.	Valves	bar	Ø mm	°C	V dc	Pack
8372032	2		19			1
8372033	3		19			1
8372034	4	20	25	60	12	1
8372035	5		25			1
8372036	6		25			1
8372037	7		25			1

Obbligatorio ordinare i raccordi separatamente.
Compulsory: fitting to be ordered separately.
Obligatoire: commander les raccords séparément.



Pag. 99

ADAPTERS



Pag. 108

I collegamenti con valvole generali VGM 4 e VGME 4, non necessitano di flange di accoppiamento.



No coupling discs are required for connections with the general valves VGM4 and VGME4.

Les raccordements aux vannes générales VGM4 et VGME4 ne nécessitent pas de brides d'accouplement.

NRG



Gruppo elettrovalvole NRG con ritorni registrabili.

Electric control unit NRG with by-pass manifold.

Groupe de vannes électriques NRG avec compensateurs de pression.



Part No.	Valves	bar	sec	°C	V dc	Type	Pack
8372026	2						
8372027	3						
8372028	4	20	0,2	60	60	"A"	1
8372029	5						
8372030	6						
8372031	7						
8372075	2						
8372039	3						
8372076	4	20	0,2	60	60	"B"	1
8372054	5						
8372077	6						
8372078	7						

"A" = a 2 fili / 2 wires / 2 fils
"B" = a 3 fili / 3 wires / 3 fils

OPTIONALS



Pag. 326 Pag. 55 Pag. 36→40 Pag. 106
Pag. 52→53

I collegamenti con valvole generali VGM 4 e VGME 4, non necessitano di flange di accoppiamento.
No coupling discs are required for connections with the general valves VGM4 and VGME4.
Les raccordements aux vannes générales VGM4 et VGME4 ne nécessitent pas de brides d'accouplement.

Obbligatorio ordinare i raccordi separatamente.
Compulsory: fitting to be ordered separately.
Obligatoire: commander les raccords séparément.

OUT
Pag. 99

ADAPTERS
Pag. 108

NRG



Gruppo elettrovalvole NRG on/off.

Electric control unit NRG.

Groupe de vannes électriques NRG.

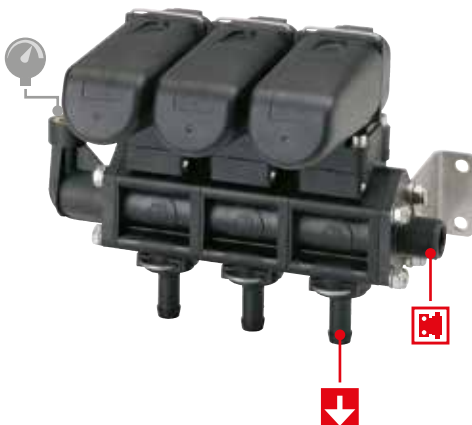

Part No.	Valves	bar	sec	°C	V dc	Type	Pack
8372020	2						
8372021	3						
8372022	4						
8372023	5	20	0,2	60	60	"A"	1
8372024	6						
8372025	7						
8372066	9						
8372069	2						
8372038	3						
8372070	4						
8372071	5	20	0,2	60	60	"B"	1
8372072	6						
8372073	7						
8372074	9						

"A" = a 2 fili / 2 wires / 2 fils
"B" = a 3 fili / 3 wires / 3 fils

OPTIONALS



Pag. 326 Pag. 55 Pag. 36→40 Pag. 106
Pag. 52→53

I collegamenti con valvole generali VGM 4 e VGME 4, non necessitano di flange di accoppiamento.
No coupling discs are required for connections with the general valves VGM4 and VGME4.
Les raccordements aux vannes générales VGM4 et VGME4 ne nécessitent pas de brides d'accouplement.

Obbligatorio ordinare i raccordi separatamente.
Compulsory: fitting to be ordered separately.
Obligatoire: commander les raccords séparément.

OUT
Pag. 99

ADAPTERS
Pag. 108

NRG



Distributore manuale con rubinetti modulari compensati e valvola volumetrica. Per completare il distributore è necessario scegliere i portagomma di uscita.

Modular valve manual control unit with metered by-pass manifold and volumetric regulating valve. When ordering specify diameter of outlet hoses you need.

Distributeur manuel ON/OFF à vannes modulaires de retour réglable avec vanne volumétrique de réglage. Préciser à la commande les diamètres des raccords de retour demandé.

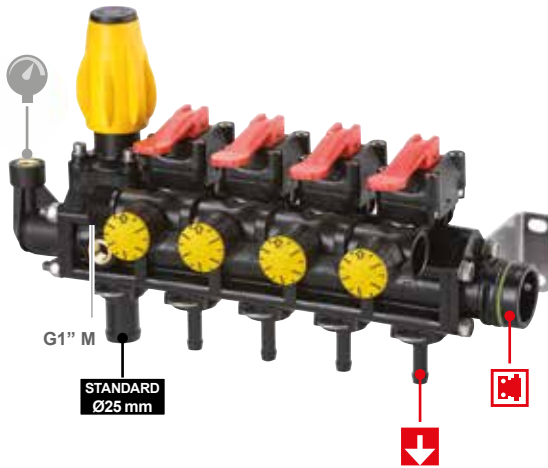

Part No.	Valves	bar	°C	Connection	Pack
8372040	3				1
8372041	4	20	60	QUICK	1
8372042	5				1
8372043	6				1

Obbligatorio ordinare i raccordi separatamente.
Compulsory: fitting to be ordered separately.
Obligatoire: commander les raccords séparément.



Adatto per / Suitable to / Approprié à

VGM 2



VGM 3



VGME 5



OPTIONALS



Pag. 326

NRG



Distributore manuale con rubinetti modulari. Per completare il distributore è necessario scegliere i portagomma di uscita.

Modular valves ON/OFF manual unit. When ordering specify diameter of outlet hoses you need.

Distributeur manuel ON/OFF à vannes modulaires. Préciser à la commande les diamètres des raccords de retour demandé.

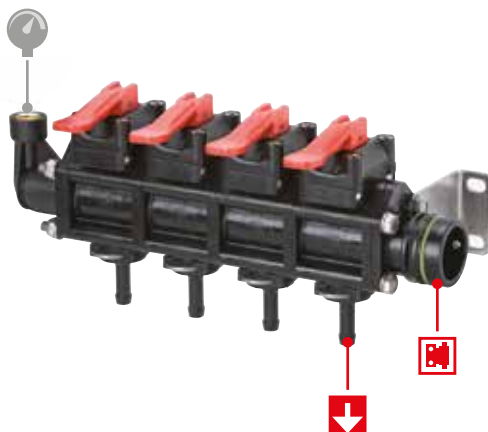

Part No.	Valves	bar	°C	Connection	Pack
8372044	2				1
8372045	3	20	60	QUICK	1
8372046	4				1
8372047	5				1
8372048	6				1
8372049	2	20	60	G 1 1/4	1
8372050	3				1
8372051	4				1
8372052	5				1
8372053	6				1

Obbligatorio ordinare i raccordi separatamente.
Compulsory: fitting to be ordered separately.
Obligatoire: commander les raccords séparément.



Adatto per / Suitable to / Approprié à

VGM 2



VGM 3



VGME 5



OPTIONALS



Pag. 326

Distributore manuale con rubinetti modulari.
Per completare il distributore è necessario scegliere i portagomma di uscita.

Modular valves ON/OFF manual unit.
When ordering specify diameter of outlet hoses you need.

Distributeur manuel ON/OFF à vannes modulaires.
Préciser à la commande les diamètres des raccords de retour demandé.



Adatto per / Suitable to / Approprié à

VGM 2

VGM 3

VGME 5



OPTIONALS



Pag. 326



Part No.	Valves	bar	°C	Connection	Pack
8372000	2				1
8372001	3				1
8372002	4	20	60	QUICK	1
8372003	5				1
8372004	6				1

Obbligatorio ordinare i raccordi separatamente.
Compulsory: fitting to be ordered separately.
Obligatoire: commander les raccords séparément.

OUT
Pag. 99



Adatto per / Suitable to / Approprié à

VGM 4

VGME 4



OPTIONALS



Pag. 326



Part No.	Valves	bar	°C	Connection	Pack
8372056	2				1
8372057	3				1
8372058	4	20	60	G 1 M	1
8372059	5				1
8372060	6				1

Obbligatorio ordinare i raccordi separatamente.
Compulsory: fitting to be ordered separately.
Obligatoire: commander les raccords séparément.

OUT
Pag. 99



Adatto per / Suitable to / Approprié à

VGM 4

VGME 4



OPTIONALS



Pag. 326



Part No.	Valves	bar	°C	Connection	Pack
8372061	2				1
8372062	3				1
8372063	4	20	60	NRG	1
8372064	5				1
8372065	6				1

Obbligatorio ordinare i raccordi separatamente.
Compulsory: fitting to be ordered separately.
Obligatoire: commander les raccords séparément.

OUT
Pag. 99



Valvola elettrica di comando generale (ad azionamento elettrico) con valvola regolabile di massima pressione (manuale).
Valvole di regolazione volumetriche manuali.

Electric main control valve with manual adjustable pressure relief valve.
Manual volumetric control valves.

Vanne électrique de commande générale (à actionnement électrique) avec vanne de pression maximale réglable (manuelle).
Vannes de réglage volumétriques manuelles.

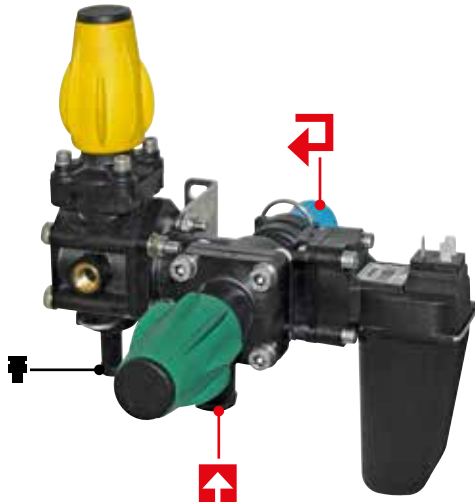

Part No.	I/1'	bar	NRG model	°C	V dc	Ø mm	Pack
8380018	180	20	NRG 72			13	1
8380019	180	20	NRG 70	60	12	19	1
8380020	180	20	NRG 74			25	1

Obbligatorio ordinare i raccordi separatamente.
Compulsory: fitting to be ordered separately.
Obligatoire: commander les raccords séparément.



Pag. 97



Pag. 97

OPTIONALS



Pag. 55



Pag. 36→40



Pag. 108

Pag. 52→53

GS VGME 5



Valvola manuale di comando generale (ad azionamento elettrico) con valvola regolabile di massima pressione (manuale).
Valvola di regolazione volumetrica elettrica.

Manual main control valve with manual adjustable pressure relief valve.
Electric volumetric control valve.

Vanne manuelle de commande générale (à actionnement électrique) avec vanne de pression maximale réglable (manuelle).
Vanne de réglage volumétrique électrique.

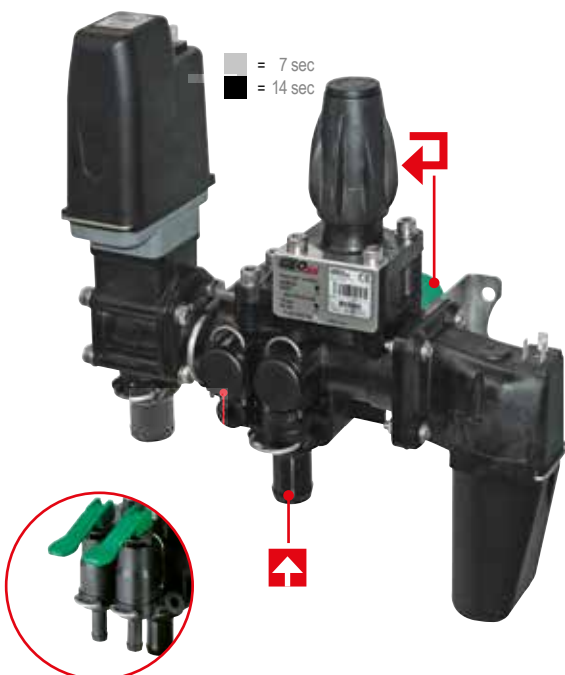

□ = 7 sec
■ = 14 sec

Part No.	I/1'	bar	sec	NRG model	No. of wires	°C	V dc	Pack
8380021	300	10	7	NRG 26	2			1
8380023	300	20	7	NRG 26	2	60	12	1
8380025	300	20	7	NRG 26	3			1
8380022	300	10	14	NRG 26	2			1
8380024	300	20	14	NRG 26	2	60	12	1
8380026	300	20	14	NRG 26	3			1

Obbligatorio ordinare i raccordi separatamente.
Compulsory: fitting to be ordered separately.
Obligatoire: commander les raccords séparément.



Pag. 97



Pag. 97

OPTIONALS



Pag. 55



Pag. 36→40



Pag. 108

Pag. 52→53



GS VGME 4



Valvola elettrica di comando generale (ad azionamento elettrico) con valvola regolabile di massima pressione (manuale).
Valvola di regolazione volumetrica elettrica.

Electric main control valve with manual adjustable pressure relief valve.
Electric volumetric control valve.

Vanne électrique de commande générale (à actionnement électrique) avec vanne de pression maximale réglable (manuelle).
Vanne de réglage volumétrique électrique.

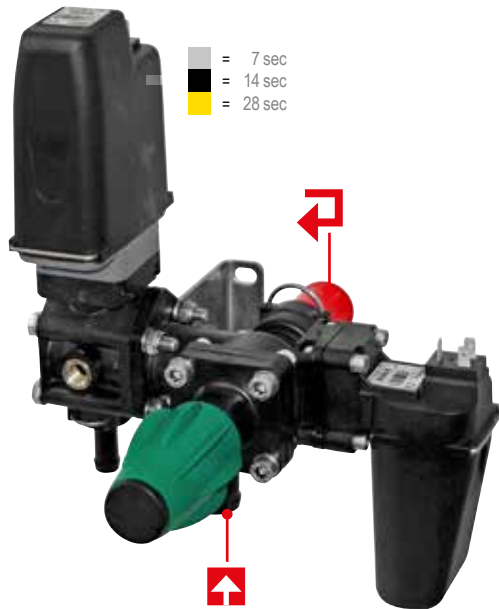

Part No.	l/1'	bar	sec	Ø mm	NRG model	No. of wires	°C	V dc	Pack
8380000	180	20	7	13	NRG 022S	2			
8380001	180	20	7	19	NRG 020	2			
8380002	180	20	7	25	NRG 024	2			
8380009	180	20	7	13	NRG 022S	3	60	12	1
8380010	180	20	7	19	NRG 020	3			
8380011	180	20	7	25	NRG 024	3			
8380003	180	20	14	13	NRG 022	2			
8380004	180	20	14	19	NRG 020	2			
8380005	180	20	14	25	NRG 024	2			
8380012	180	20	14	13	NRG 022	3	60	12	1
8380013	180	20	14	19	NRG 020	3			
8380014	180	20	14	25	NRG 024	3			
8380006	180	20	28	13	NRG 022	2			
8380007	180	20	28	19	NRG 020	2			
8380008	180	20	28	25	NRG 024	2			
8380015	180	20	28	13	NRG 022	3	60	12	1
8380016	180	20	28	19	NRG 020	3			
8380017	180	20	28	25	NRG 024	3			

OPTIONALS



Pag. 55



Pag. 36→40



Pag. 108



Pag. 6→35

Pag. 52→53



Obbligatorio ordinare i raccordi separatamente.
Compulsory: fitting to be ordered separately.
Obligatoire: commander les raccords séparément.



Pag. 97

BY-PASS



Pag. 97

VGME 4



Valvola elettrica di comando generale (ad azionamento elettrico) con valvola regolabile di massima pressione (manuale).

Electric main control valve with manual adjustable pressure relief valve.

Vanne générale électrique avec vanne manuelle réglable de pression maxi.



Part No.	l/1'	bar	sec	°C	V dc	Type	Pack
8370029	<60	20				"A"	1
8370014		10				"A"	1
8370015	180	20	0,2	60	12	"A"	1
8370016		30				"A"	1
8370025		20				"B"	1

OPTIONALS



Pag. 55



Pag. 36→40



Pag. 6→35

Pag. 52→53



Obbligatorio ordinare i raccordi separatamente.
Compulsory: fitting to be ordered separately.
Obligatoire: commander les raccords séparément.



Pag. 97

BY-PASS



Pag. 97

"A" = a 2 fili / 2 wires / 2 fils
"B" = a 3 fili / 3 wires / 3 fils

VGME 5



Valvola manuale di comando generale (ad azionamento elettrico) con valvola regolabile di massima pressione (manuale).

Manual main control valve with manual adjustable pressure relief valve.

Vanne générale manuelle avec vanne manuelle réglable de pression maxi.



"A" = a 2 fili / 2 wires / 2 fils
"B" = a 3 fili / 3 wires / 3 fils



Part No.	l/1'	bar	sec	°C	V dc	Type	Pack
8370021		10				"A"	1
8370022	300	20	0,5	60	12	"A"	1
8370027		20				"B"	1

Obbligatorio ordinare i raccordi separatamente.
Compulsory: fitting to be ordered separately.
Obligatoire: commander les raccords séparément.

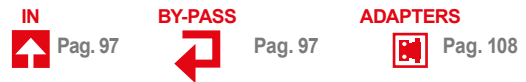

OPTIONALS

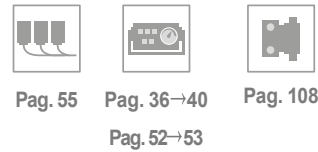

VGME 5



Valvola manuale di comando generale (ad azionamento elettrico) con valvola regolabile di massima pressione (manuale).

Manual main control valve with manual adjustable pressure relief valve.

Vanne générale manuelle avec vanne manuelle réglable de pression maxi.

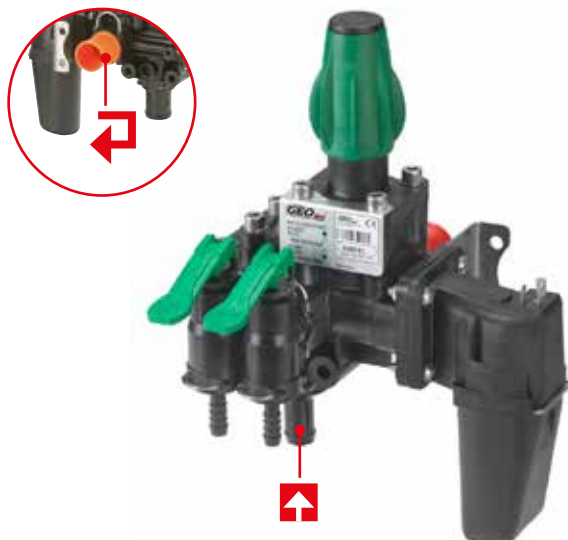

"A" = a 2 fili / 2 wires / 2 fils
"B" = a 3 fili / 3 wires / 3 fils



Part No.	l/1'	bar	sec	°C	V dc	Type	Pack
8370024		20				"A"	1
8370019	300	20	0,5	60	12	"B"	1

Obbligatorio ordinare i raccordi separatamente.
Compulsory: fitting to be ordered separately.
Obligatoire: commander les raccords séparément.

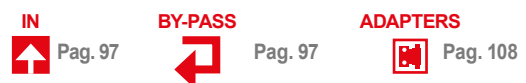

OPTIONALS

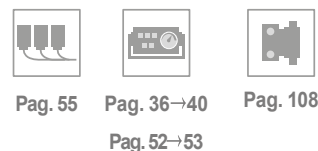

VGM 3



Valvola comando generale manuale VGM 3 a tre posizioni con valvola di max. pressione regolabile. Per completare il comando è necessario scegliere i portagomma di entrata, uscita e by-pass.

Manual three positions main valve VGM 3 with adjustable relief valve
When ordering specify diameter of inlet, outlet and by-pass hoses.

Vanne générale manuelle VGM 3 à trois positions avec vanne réglable de pression maxi
Préciser à la commande, les diamètres des raccords d'entrée, retour et by-pass.



OPTIONALS



Pag. 108

Part No.	I/1'	bar	°C	Pack
8370002	210	20	60	1

Obbligatorio ordinare i raccordi separatamente.
Compulsory: fitting to be ordered separately.
Obligatoire: commander les raccords séparément.



Pag. 97



Pag. 99



Pag. 97

VGM 2



Valvola comando generale manuale VGM 2 con valvola di max. pressione regolabile. Per completare il comando è necessario scegliere i portagomma di entrata e by-pass.

Manual main valve with adjustable relief valve VGM 2.
When ordering specify diameter of inlet and by-pass hoses.

Vanne générale manuelle avec vanne réglable de pression maxi VGM 2.
Préciser à la commande, les diamètres des raccords d'entrée et by-pass.



OPTIONALS



Pag. 108

Part No.	I/1'	bar	°C	Pack
8370001	150	20	60	1

Obbligatorio ordinare i raccordi separatamente.
Compulsory: fitting to be ordered separately.
Obligatoire: commander les raccords séparément.



Pag. 97



Pag. 97

VGM 4



Valvola di comando generale manuale con valvola regolabile di massima pressione manuale.

Manual main control valve with manual adjustable pressure relief valve.

Vanne générale manuelle avec vanne manuelle réglable de pression maxi.



Part No.	I/1'	bar	°C	Pack
8370031	<60	20		1
8370011		10	60	1
8370012	180	20		1
8370013		30		1

Obbligatorio ordinare i raccordi separatamente.
Compulsory: fitting to be ordered separately.
Obligatoire: commander les raccords séparément.



Pag. 97



Pag. 97



IN

Kit portagomma di entrata.

Inlet hosetail kit.

Kit porte-tuyau d'entrée.

Suitable for:



Type	Part No.	Ø	Gasket	Pack
	8392028	19 mm		1
	8392029	25 mm	G00001029	1
	8392030	35 mm		1



Type	Part No.	Ø	Gasket	Pack
	8392072	G 3/4 M		1
	8392074	G 1 M	G00001158	1
	8392085	1" NPT F		1
	8392084	19 mm		1
	8392073	25 mm	G00001158	1
	8392081	30 mm		1
	8392082	32 mm		1
	8392083	25 mm	G00001158	1



BY-PASS

Kit portagomma di scarico.

By-pass hosetail kit.

Kit porte-tuyau by-pass.

Suitable for:



RISUCCHIO / ANTI-DRIPSYSTEM / ANTI-GOUTTE

Type	Part No.	Ø	I/I' MAX	Gasket	Pack
	8392025	35 mm	60	G00001029	1
	8392026	35 mm	120		
	8392027	35 mm	250		
	8392063	40 mm	300		
	8392031	G 1 M	60	G00001029	1
	8392032	G 1 M	120		
	8392033	G 1 M	250		

Filettato / Threaded / Fileté

Type	Part No.	Ø	I/I' MAX	Gasket	Pack
	8392028	19 mm	200	G00001029	1
	8392029	25 mm	250		
	8392030	35 mm	300		

Valvola elettrica On/Off di sezione per barra.

On/Off electric section valve for spraying boom and orchard sprayers.

Vanne électrique de section On/Off, pour rampe de désherbage et atomiseurs.

NRG PLUS 001



Part No.	l/1'	bar	sec	°C	V dc	Type	Pack
8388003	120*	20	0,20	60	12	"A"	1
8388014	120*	20	0,20			"B"	1

"A" = a 2 fili / 2 wires / 2 fils
"B" = a 3 fili / 3 wires / 3 fils



Obbligatorio ordinare i raccordi separatamente.
Compulsory: fitting to be ordered separately.
Obligatoire: commander les raccords séparément.

OUT
Pag. 99

OPTIONALS

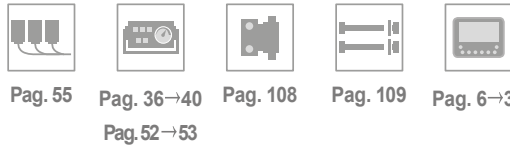

* Valore variabile in funzione del diametro del portagomma, con pressione di 0,5bar.
* Value varies depending on diameter of hose-tail, with 0,5bar pressure.
* Valeur variant en fonction du diamètre du raccord, avec pression de 0,5bar.

NRG PLUS 011

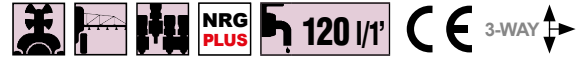

Part No.	l/1'	bar	sec	°C	V dc	Type	Pack
8388004	120*	20	0,20	60	12	"A"	1
8388015	120*	20	0,20			"B"	1

"A" = a 2 fili / 2 wires / 2 fils
"B" = a 3 fili / 3 wires / 3 fils



A 3 VIE / 3-WAY / A 3 VOIES

NRG 001



Part No.	l/1'	bar	sec	°C	V dc	Type	Pack
8388000	15*÷45*	20	0,20	60	12	"A"	1
8388002						"B"	1

"A" = a 2 fili / 2 wires / 2 fils
"B" = a 3 fili / 3 wires / 3 fils



Obbligatorio ordinare i raccordi separatamente.
Compulsory: fitting to be ordered separately.
Obligatoire: commander les raccords séparément.

OUT
Pag. 99

OPTIONALS

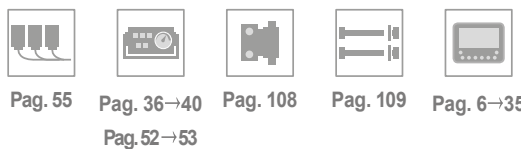

* Valore variabile in funzione del diametro del portagomma, con pressione di 0,5bar.
* Value varies depending on diameter of hose-tail, with 0,5bar pressure.
* Valeur variant en fonction du diamètre du raccord, avec pression de 0,5bar.

NRG 011



Part No.	l/1'	bar	sec	°C	V dc	Type	Pack
8388001	15*÷45*	20	0,20	60	12	"A"	1
8388005						"B"	1

"A" = a 2 fili / 2 wires / 2 fils
"B" = a 3 fili / 3 wires / 3 fils



A 3 VIE / 3-WAY / A 3 VOIES

Valvola manuale On/Off di sezione per barra.

Manual On/Off section valve for spraying boom and orchard sprayers.

Vanne manuelle de section On/Off, pour rampe de désherbage et atomiseurs.

NRG 051



Part No.	I/I'	bar	°C	Pack
8388006	15* ÷ 45*	20	60	1



Obbligatorio ordinare i raccordi separatamente.
Compulsory: fitting to be ordered separately.
Obligatoire: commander les raccords séparément.

OUT
Pag. 99

OPTIONALS



Pag. 108



Pag. 109



Pag. 110

* Valore variabile in funzione del diametro del portagomma, con pressione di 0,5bar.
* Value varies depending on diameter of hose-tail, with 0,5bar pressure.
* Valeur variant en fonction du diamètre du raccord, avec pression de 0,5bar.

NRG 061



Part No.	I/I'	bar	°C	Pack
8388007	15* ÷ 45*	20	60	1



A 3 VIE / 3-WAY / A 3 VOIES

OUT

Raccordi d'uscita per valvole sezione barra.
O-ring non incluso nei raccordi.
Da ordinare separatamente

Boom section valves hosetails.
O-Ring for fittings not included.
To be ordered separately.

Raccord de sortie pour vannes section de rampe.
O-Ring pas compris dans les raccords.
A commander séparément



OUT → NRG PLUS series

Part No.	Ø mm	Type	Pack
G00001021	/	OR Viton®	50
R00000074	19		
R00000098	25		1
R00000076	30		
R00000078	Ø25 mm	90° →	1
R00000093	G 3/4 M		1
R00000097	G1 M		1
R00000075	1 NPT F		1

NRG PLUS

NRG PLUS

NRG PLUS

NRG PLUS

* Ottone / Brass / Laiton
✓ Only for VOLUMETRIC VALVES

OUT → NRG series

Part No.	Ø mm	Type	Pack
G00001059	/	OR Viton®	50
R00000014	10		
R00000015	13		
R00000016	16		1
R00000017	19		
R00000018	25		
✓ R00000019	25	Øi16	
R00000082	13	90° →	1
R00000255	10		
* R00000083	G 3/4 M		
✓ R00000122	G 3/4 M	Øi16	1
* R00000066	G 1/2 M		
R00000084	G 3/4 F		1
R00000085	3/4 NPT F		1

Valvola elettrica On/Off di sezione per barra.
Completa di raccordo d'uscita in ottone.

On/Off electric section valve for spraying boom and
orchard sprayers. Brass outlet hosetails included.

Vanne électrique de section On/Off, pour rampe
de désherbage et atomiseurs. Avec raccords de
sortie en laiton.

NRG 001



Part No.	l/1'	bar	sec	°C	V dc	Type	Pack
8545017	25*	40	0,20	60	12	"A"	1
8545019						"B"	1

"A" = a 2 fili / 2 wires / 2 fils
"B" = a 3 fili / 3 wires / 3 fils



G1/2 M

OPTIONALS

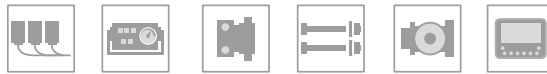

Pag. 55 Pag. 36→40 Pag. 108 Pag. 109 Pag. 110 Pag. 6→35
Pag. 52→53

* Valore variabile in funzione del diametro del portagomma, con pressione di 0,5bar.
* Value varies depending on diameter of hose-tail, with 0,5bar pressure.
* Valeur variant en fonction du diamètre du raccord, avec pression de 0,5bar.

NRG 011



Part No.	l/1'	bar	sec	°C	V dc	Type	Pack
8545018	25*	40	0,20	60	12	"A"	1
8545020						"B"	1

"A" = a 2 fili / 2 wires / 2 fils
"B" = a 3 fili / 3 wires / 3 fils



G1/2 M

A 3 VIE / 3-WAY / A 3 VOIES

Valvola manuale On/Off di sezione per barra.
Completa di raccordo d'uscita in ottone.

Manual On/Off section valve for spraying boom
and orchard sprayers. Brass outlet hosetails
included.

Vanne manuelle de section On/Off, pour rampe
de désherbage et atomiseurs. Avec raccords de
sortie en laiton.

NRG 051



Part No.	l/1'	bar	°C	Pack
8550008	25	40	60	1



G1/2 M

OPTIONALS



Pag. 108 Pag. 109 Pag. 110

NRG 061



Part No.	l/1'	bar	°C	Pack
8550009	25	40	60	1



G1/2 M

Valvola elettrica di scarico serie NRG.
Completa di raccordo d'uscita in ottone.

Electric dump valve NRG series.
Brass outlet hoseetails included.

Vanne électrique de vidage serie NRG. Avec
raccords de sortie en laiton.

OPTIONALS



Pag. 55 Pag. 36→40 Pag. 108 Pag. 109 Pag. 6→35
Pag. 52→53



G3/4 M

NRG DUMP

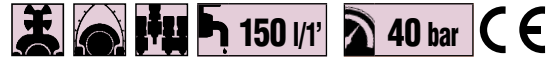

Part No.	l/1'	bar	sec	°C	V dc	Type	Pack
8370026	150	40	0,20	60	12	"A"	1
8370028						"B"	1

"A" = a 2 fili / 2 wires / 2 fils
"B" = a 3 fili / 3 wires / 3 fils

Valvola di regolazione volumetrica elettrica.
Electric volumetric control valve.
Vanne volumétrique électrique.

□ = 7 sec
■ = 14 sec

OPTIONALS



Pag. 55 Pag. 36→40 Pag. 108 Pag. 109 Pag. 6→35
Pag. 52→53

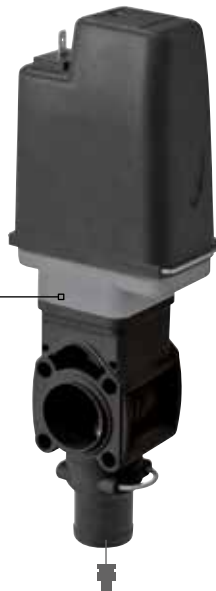

020S
020 14S

NRG PLUS 026



Part No.	l/1'	bar	sec	Ø	°C	V dc	Pack
8386009	240	20	7	30 mm	60	12	1
8386008	240	20	14	30 mm			

Valvola di regolazione volumetrica elettrica.
Electric volumetric control valve.
Vanne volumétrique électrique.

□ = 7 sec
■ = 14 sec
■ = 28 sec

OPTIONALS



Pag. 55 Pag. 36→40 Pag. 108 Pag. 109 Pag. 6→35
Pag. 52→53



NRG 022S
NRG 020
NRG 024
NRG 024 7S 40bar
NRG 022 14S
NRG 020 14S
NRG 024 14S
NRG 022
NRG 020
NRG 024

NRG serie 02_



Part No.	l/1'	bar	sec	Ø	°C	V dc	Pack
8386011	60	40	7	13 mm			
8386010	100	40	7	19 mm	60	12	1
8386006	150	20	7	25 mm			
8386017	200	40	7	G 3/4			
8386015	60	40	14	13 mm			
8386016	100	40	14	19 mm	60	12	1
8386023	200	40	14	G3/4			
8386003	60	40	28	13 mm			
8386004	100	40	28	19 mm	60	12	1
8386005	150	40	28	25 mm			

Valvole di regolazione volumetriche manuali.

Manual volumetric control valves.

Vannes volumétrique manuelles.

NRG PLUS 076



Part No.	l/1'	Ø	bar	°C	Pack
8386007	240	30 mm	20	60	1

OPTIONALS



Pag. 108



Pag. 109

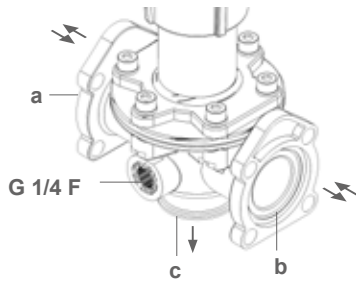

Attacchi flangiati per valvole serie NRG.
Flanged for NRG series valves.
Raccords bridés pour vannes série NRG.

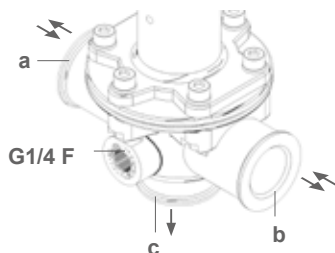

Con attacchi filettati.
With threaded fittings.
Avec raccords filetés.

NRG serie 07_



Part No.	l/1'	Ø	bar	°C	Pack
8386000	60	13 mm			1
8386001	100	19 mm	40	60	1
8386002	150	25 mm			1

NRG 072
NRG 070
NRG 074

OPTIONALS



Pag. 108



Pag. 109



* flow ⇒ 1,5 bar



Part No.	l/1'*	bar	a	b	c	by-pass	°C	Pack
8386021	180	20	F	F	G1 M		60	1

OPTIONALS



Pag. 326



Pag. 108



* flow ⇒ 1,5 bar



Part No.	l/1'*	bar	a	b	c	by-pass	°C	Pack
8386020	125	20	G 3/4 F	G 3/4 F	G 3/4 F			1
8386019	160	50	G 3/4 F	G 3/4 F	G 3/4 F		60	1
8386018	180	20	G1 M	G1 M	G1 M			1

OPTIONALS



Pag. 326



Pag. 108

Valvola regolazione pressione a membrana ad azionamento elettrico.

Electric diaphragm pressure relief valve.

Vanne électrique à membrane de réglage pression.

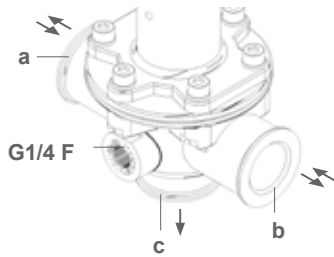

Con attacchi filettati.
With threaded fittings.
Avec raccords filetés.



Part No.	l/1'	bar	a	b	c	by-pass	°C	sec	Vdc	A	Pack
8384019		10									
8384020		20									
8384021	150	30	G 3/4 F	G 3/4 F	G 3/4 F		60	50	12	3	1
8384022		40									
8384023		50									
8384024	200	10	G 1 M	G 1 M	G 1 M		60	50	12	3	1
8384025		20									

OPTIONALS

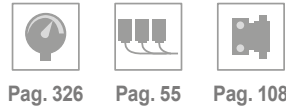

Pag. 326 Pag. 55 Pag. 108

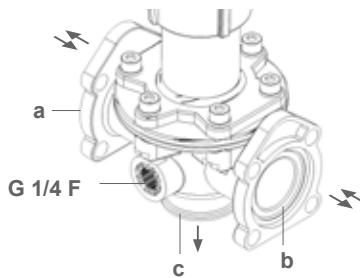

Attacchi flangiati per valvole serie NRG.
Flanged for NRG series valves.
Raccords bridés pour vannes série NRG.

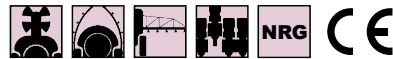

Part No.	l/1'	bar	a	b	c	by-pass	°C	sec	Vdc	A	Pack
8384026		30									
8384027	150	40			G 3/4 F		60	50	12	2	1
8384028		10	M	F							
8384029	200	20			G 1 M						

OPTIONALS

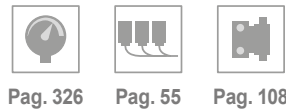

Pag. 326 Pag. 55 Pag. 108

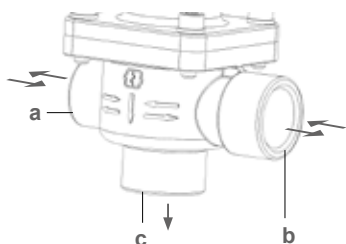

Part No.	l/1'	bar	a	b	c	by-pass	°C	sec	Vdc	A	Pack
8384034											
8384035	150	50	G 1/2 F	G 3/4 F	G 3/4 F G 1 M		60	50	12	3	1

OPTIONALS

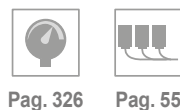

Pag. 326 Pag. 55

Valvola manuale regolazione pressione a membrana. *Manual diaphragm pressure relief valve.*

Vanne manuelle à membrane de réglage pression maxi. *maxi.*

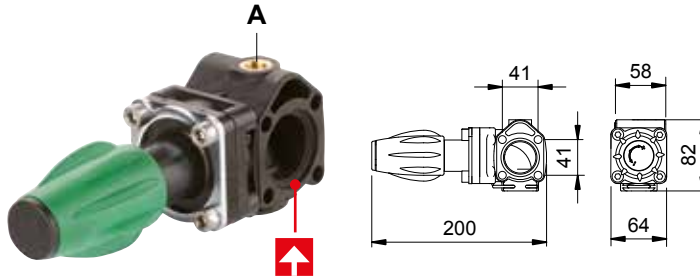

Obbligatorio ordinare i raccordi separatamente.
Compulsory: fitting to be ordered separately.
Obligatoire: commander les raccords séparément.

OUT
↓ Pag. 99

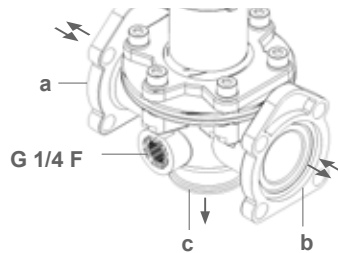

Attacchi flangiati per valvole serie NRG.
Flanged for NRG series valves.
Raccords bridés pour vannes série NRG.

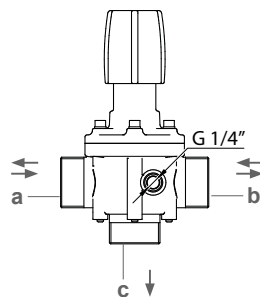

Con attacchi filettati.
With threaded fittings.
Avec raccords filetés.

NRG serie 68_



Part No.	l/1'	bar	°C	Pack	
683 8384036		10	60	1	
680 8384037	120	20		G 1/2 F	1
681 8384038		30		G 1/4 F	1
682 8384039		40			1

OPTIONALS



Pag. 326 Pag. 108 Pag. 109



Part No.	l/1'	bar	by-pass	°C	Pack
8384015	150	30	F M	60	1
8384016		40			G 3/4 F
8384017	200	10	G 1 M	60	1
8384018		20			1

OPTIONALS

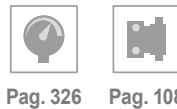

Pag. 326 Pag. 108



Part No.	l/1'	bar	a	b	c	°C	Pack
8384008		10				60	1
8384009		20					
8384010	150	30	G 3/4 F	G 3/4 F	G 3/4 F		
8384011		40					
8384012		50				60	1
8384013	200	10	G 1 M	G 1 M	G 1 M		
8384014		20					

OPTIONALS



Pag. 326

Valvola manuale regolazione pressione a membrana. *Manual diaphragm pressure relief valve.*

Vanne manuelle à membrane de réglage pression maxi.

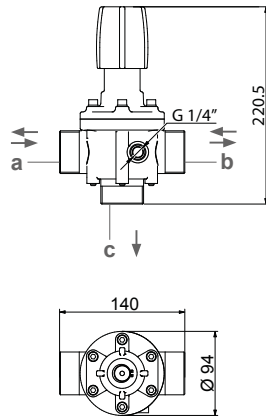

Con attacchi filettati.
With threaded fittings.
Avec raccords filetés.



Part No.	l/1'	bar	a	b	c	by-pass	°C	Pack
8384049	400	20	G 1 1/2 M	G 1 1/2 M	G 1 1/2 M		60	1

OPTIONALS



Pag. 326

Valvola manuale regolazione pressione a membrana, in ottone, con attacchi filettati. *Brass manual diaphragm pressure relief valve with threaded fittings.*

Vanne manuelle à membrane de réglage pression en laiton avec raccords filetés.

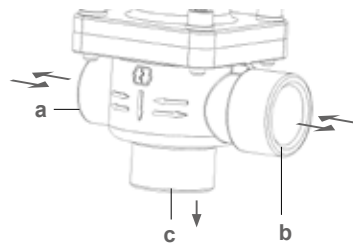

Part No.	l/1'	bar	a	b	c	by-pass	°C	Pack
8384030		30						
8384041		40	G 1/2 F	G 3/4 F	G 3/4 F			
8384031		50						
8384032	150	30					60	5
8384042		40	G 1/2 F	G 3/4 F	G 1 M			
8384033		50						

OPTIONALS



Pag. 326

Valvola di regolazione manuale di massima pressione. *Manual adjustable pressure relief valve.*

Vanne réglable manuelle de pression maxi.

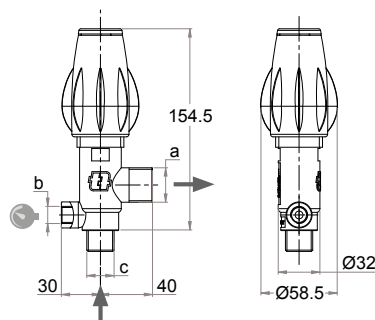

Part No.	l/1'	bar	a	b	c	by-pass	°C	Pack
8384043		4	G 3/4 M	G 1/4 F	G 1/2 M			
8384045		70			G 3/4 M		60	20
8384044		10	G 3/4 M	G 1/4 F	G 1/2 M			
8384046		10	G 3/4 M	G 1/4 F	G 3/4 M			

OPTIONALS



Pag. 326

Dispositivo scarico pressione ad azionamento meccanico - Valvole NRG

- Consente di azzerare la pressione residua del liquido che rimane intrappolato tra le valvole di sezione e valvola antigoccia, riducendo il gocciolamento;
- Azionamento a comando indotto dal motoriduttore della valvola;
- Montaggio modulare con attacco a forchetta per facilitare l'installazione e l'ispezione;
- Applicabile a tutti i gruppi Geoline.

Exhaust device with mechanical actuating - NRG Valves
- Used to bleed off the residual pressure of the liquid that remains trapped between the section valves and check valve, thus reducing dripping;
- Induced control drive via valve geared motor;
- Modular assembly with fork coupling for easier installation and inspection;
- Can be fitted and retrofitted to all electric Geoline control units.

Dispositif de décharge pression à actionnement mécanique - Vannes NRG

- Il permet de remettre à zéro la pression résiduelle du liquide qui reste emprisonné entre les vannes de section et la vanne anti-goutte pour réduire l'égouttement;
- Actionnement à commande induite par le motoréducteur de la vanne;
- Montage modulaire avec fixation à étrier pour faciliter l'installation et l'inspection;
- Applicabile a tous les groupes Geoline.

NEW

AF3
FORK

AF5
FORK



Part No.	bar	A	B	C	D	kg	Pack
8392086	20	NRG	AF5	AF3	AF5	0,2	1

DIMENSIONS

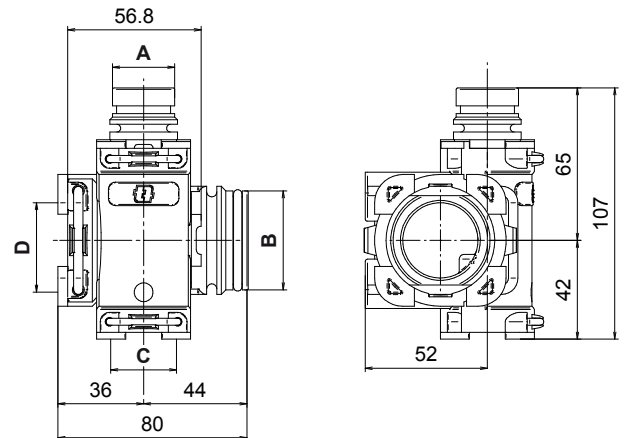

OPTIONALS



Pag. 67-69

MOUNTING

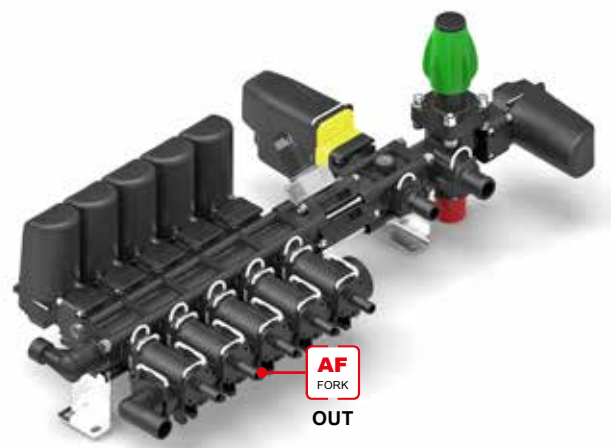
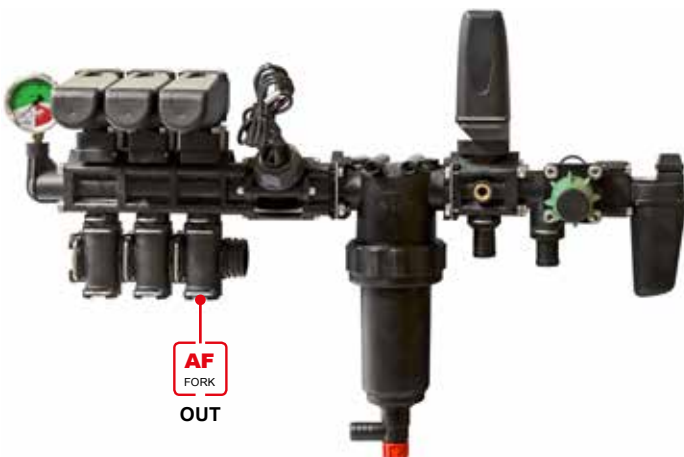

REDUCING PRESSURE RESIDUAL IN THE BOOMS

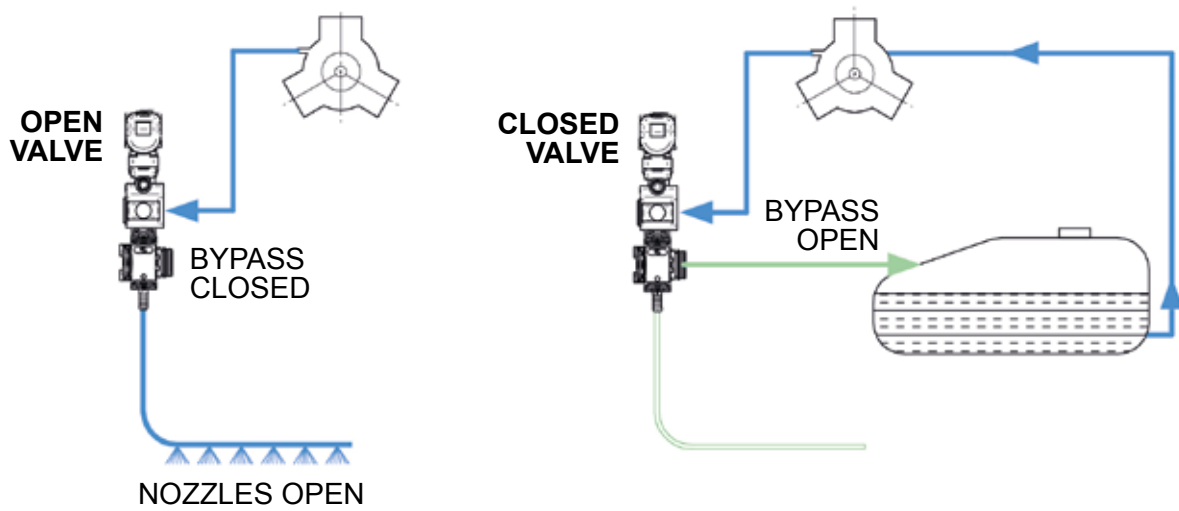

RECIRCULATION IN PIPES

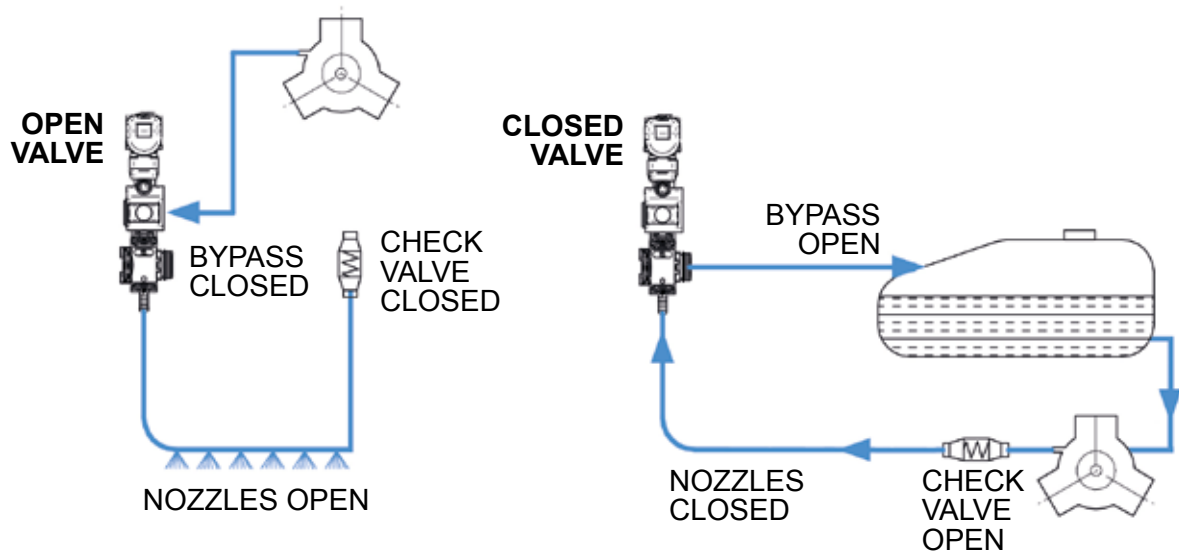

CLEANING PIPES AT END OF CYCLE

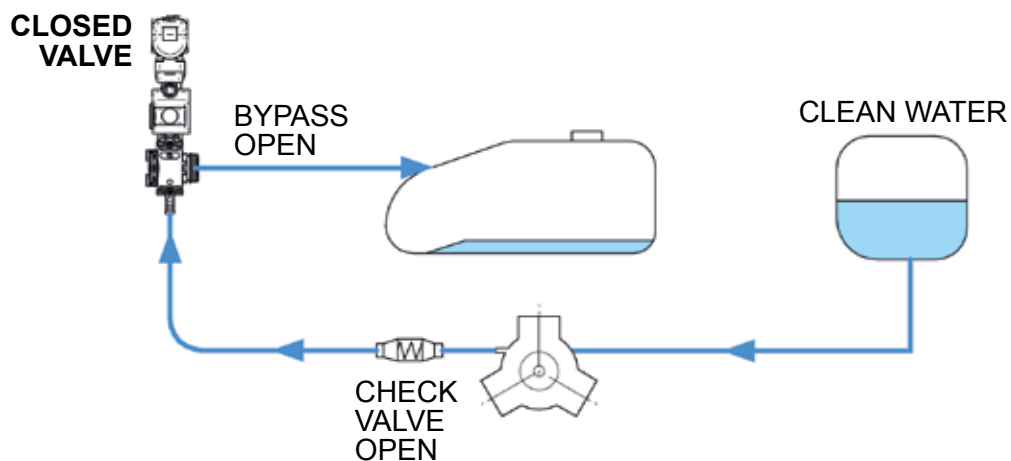



ADAPTERS → NRG & NRG PLUS

Flange di accoppiamento per valvole elettriche NRG e NRG PLUS.

Adapters for electric valves NRG and NRG PLUS.

Brides d'assemblage pour vannes électriques NRG et NRG PLUS.

ADAPTERS >> FEMALE

Flangia filetto maschio
Male threaded adapter
Bride filetage male

Part No.	Ø	Pack
F00102000	G 3/4	1
F00102001	G 1	1
F00102002	G 1 1/4	1
F00102024	G 1 1/2	1
* F00102014	G 3/4	1

Flangia filetto femmina
Female threaded adapter
Bride filetage femelle

Part No.	Ø	Pack
F00102003	G 3/4	1
F00102004	G 1	1
F00102019	3/4 NPT	1
F00102020	1 NPT	1

Flangia chiusa
Closed adapter
Bride serrée

Part No.	Pack
F00102005	1
* F00102015	1

Flangia AF femmina
Female AF adapter
Bride AF male

Part No.	Type	Pack
NEW F00102028	AF5	1

Flangia AF maschio
Male AF adapter
Bride AF male

Part No.	Type	Pack
NEW F00102035	AF5	1

Adattatore NRG/DIS
Adapter NRG/DIS
Adaptateur NRG/DIS

Part No.	Pack
F00102018	1

Flangia porta manometro
Pressure gauge adapter
Bride pour manomètre

Part No.	Ø	Pack
NEW F00102030	G 1/4	1
* F00102016	G 1/4	1
F00102025	1/4 NPT	1

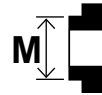

ADAPTERS >> MALE

Flangia filetto maschio
Male threaded adapter
Bride filetage male

Part No.	Ø	Pack
F00102007	G 3/4	1
F00102008	G 1	1
F00102009	G 1 1/4	1
F00102023	G 1 1/2	1
* F00102017	G 3/4	1

Flangia filetto femmina
Female threaded adapter
Bride filetage femelle

Part No.	Ø	Pack
F00102010	G 3/4	1
F00102011	G 1	1
F00102021	3/4 NPT	1
F00102022	1 NPT	1

Flangia chiusa
Closed adapter
Bride serrée

Part No.	Pack
F00102012	1

Flangia AF maschio
Male AF adapter
Bride AF male

Part No.	Type	Pack
F00102026	AF5	1

Flangia AF maschio
Male AF adapter
Bride AF male

Part No.	Type	Pack
F00102034	AF5	1

Kit adattatore VGE-VGM-VGME-NRG
Adapter kit VGE-VGM-VGME-NRG
Kit adaptateur VGE-VGM-VGME-NRG

Part No.	Pack
8392062	1

Fino ad esaurimento
Selling out
Jusqu'à épuisement



ASSEMBLING KIT → NRG & NRG PLUS

Kit di assemblaggio valvole in acciaio inox, serie NRG ed NRG PLUS.

Stainless steel assembling kit for valves, NRG and NRG PLUS serie.

Kit d'assemblage en acier inox pour vannes, serie NRG et NRG PLUS.

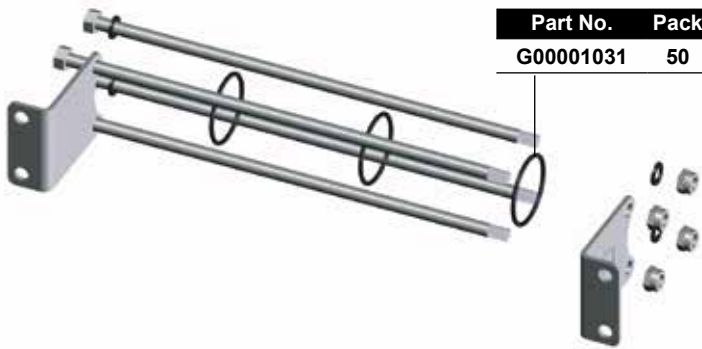

Part No.	Pack
G00001031	50

Part No.	Part No.	Valves	L	Pack
INOX	ZINC COATING		mm	
8392034	8392075	1	85	1
8392035	8392076	2	140	1
8392036	8392077	3	200	1
8392037	8392078	4	256	1
8392038	8392079	5	315	1
8392039	8392080	6	370	1
8392040	/	7	430	1
8392041	/	8	485	1
8392042	/	9	545	1



MANIFOLDS KIT → NRG

Kit collettori compensatori per valvole serie NRG

Kit of compensating manifolds for NRG valves.

Kit collecteurs compensateurs pour vannes série NRG.

NRG

Part No.	Pack
F0000011	1

Collettori con valvola di bilanciamento.
Manifolds with balancing valve.
Collecteurs avec vanne de réglage.

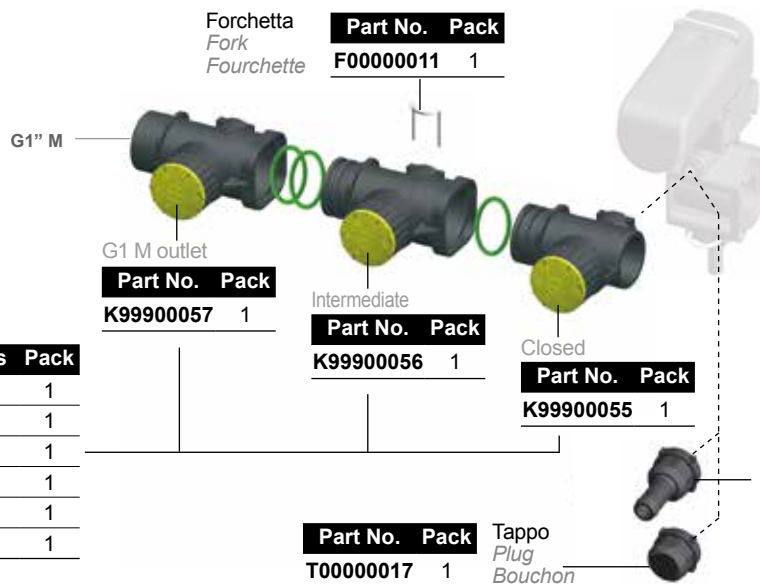

Part No.	Pack
K99900057	1

Part No.	Pack
K99900056	1

Part No.	Pack
K99900055	1

Portagomma
Hosetail
Porte-tuyau

Part No.	Ø mm	Pack
R00000064	13	1
R00000065	16	1

Part No.	Pack
T00000017	1

Tappo
Plug
Bouchon



Part No.	Valves	Pack
8392043	2	1
8392044	3	1
8392045	4	1
8392046	5	1
8392047	6	1
8392048	7	1



MANIFOLDS KIT → NRG

Kit collettori compensatori per valvole serie NRG

Kit of compensating manifolds for NRG valves.

Kit collecteurs compensateurs pour vannes série NRG.

NRG

Part No. Pack
G00001023 1

Closed

Part No.	Ø mm	Pack
8392050	10	1
8392059	12,5	1
8392049	14	1
8392051	16	1

Intermediate

Part No.	Ø mm	Pack
8392053	10	1
8392060	12,5	1
8392052	14	1
8392054	16	1

G1 M outlet

Part No.	Ø mm	Pack
8392056	10	1
8392061	12,5	1
8392055	14	1
8392057	16	1



MANIFOLDS KIT → NRG PLUS

Flange di completamento per collettori compensatori valvole serie NRG PLUS.

Accessory discs for NRG PLUS valves' compensating manifolds.

Brides pour collecteurs compensateurs vannes série NRG PLUS.

NRG PLUS

Part No.	Type	Pack
C00600022	G1½ M	1

Part No.	Type	Pack
T00000037	closed M	1

Part No.	Pack
G00001074	50

Part No.	Type	Pack
T00000046	closed F	1

Part No.	Type	Pack
C00600020	G1½ M	1

Part No.	Pack
F00000018	1

Rapid Fan



Flussometro ispezionabile con turbina.

- Per applicazioni agricole, industriali, nautiche, mobili, ecc..
- Di facile installazione e manutenzione;
- Affidabile;
- Turbina in materiale anticorrosione Acciaio Inox alta resistenza;
- Cuscinetti in zaffiro;
- Completo di flange d'accoppiamento NRG Geoline 1" ;
- Corpo in poliarilammide rinforzato con fibra di vetro;
- Alimentazione 9-32 V DC;
- Spia di alimentazione a LED.

Uscita: NPN Open Collector (Max 200 mA)

Precisione: minore o Uguale 1% FSO

Impulsi (Tipici): 700 Imp/Litro

Inspectable flowmeter with turbine.

- For agricultural, industrial, nautical, mobile, etc. applications.
- Easy to install and maintain;
- Reliable;
- Turbine made of corrosion proof High resistance Stainless Steel;
- Sapphire bearings;
- Complete with NRG Geoline 1" coupling flanges;
- Glass fibre reinforced polyarylamide body;
- 9-32 V DC power supply;
- LED power light.

Outlet: NPN Open Collector (Max 200 mA)

Precision: less or equal to 1% FSO

Impulses (Typical): 700 imp/l

Débitmètre pouvant être inspecté, avec turbine.

- Pour des applications agricoles, industrielles, nautiques, mobiles, etc.
- Installation et entretien faciles;
- Fiable;
- Turbine en matériau anticorrosion Acier Inox haute résistance;
- Roulements en saphir;
- Équipé de brides d'accouplement NRG Geoline 1" ;
- Corps en polyarylamide renforcée avec de la fibre de verre;
- Alimentation 9-32 V DC;
- Témoin d'alimentation à LED.

Sortie: NPN collecteur ouvert (max. 200 mA)

Précision: inférieure ou égale 1 % FSO

Impulsions (typiques): 700 imp/l

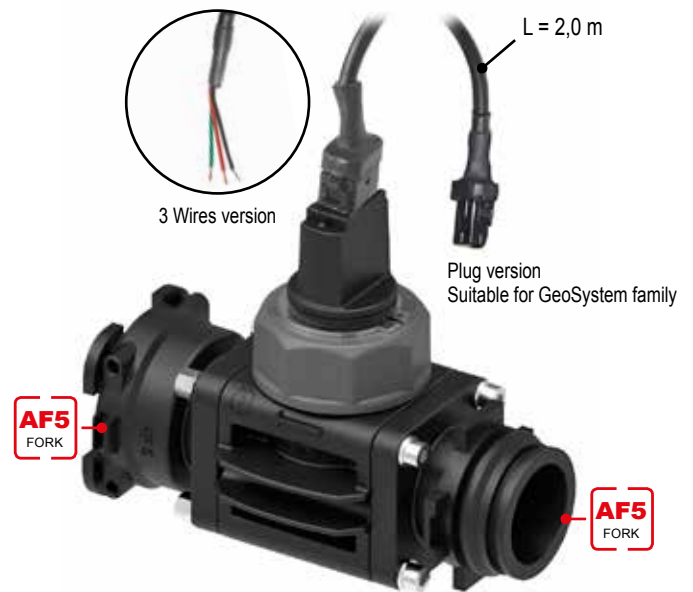

	Part No.	I/I'	bar	ERR. % FSO	°C	V dc	Pack
3 Wires	8404012	10÷200	50	≤ 1	0 → +70	9 - 32 ~0,6	1
Plug	8404026	10÷200	50	≤ 1	0 → +70	9 - 32 ~0,6	1

	Part No.	Type	I/I'	bar	ERR. % FSO	°C	V dc	Pack
3 Wires	8404027	F - M	10÷100	50	≤ 1	0 → +70	9 - 32 ~0,6	1
Plug	8404028							
3 Wires	8404034	F - F	10÷100	50	≤ 1	0 → +70	9 - 32 ~0,6	1
Plug	8404035							

PRESSURE DROP

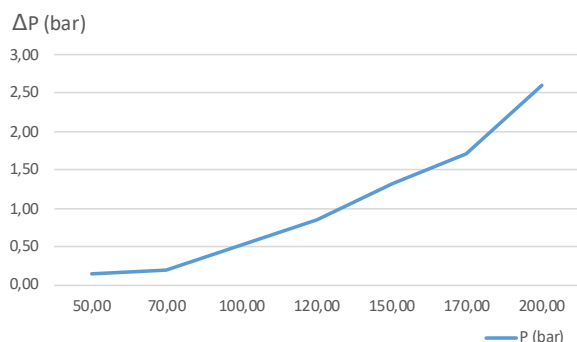

PRESSURE DROP

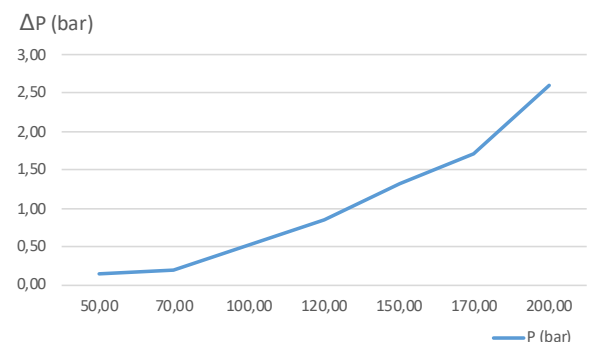

Rapid Fan



Use



ACCESSORIES & SPARE PARTS

Part No.	Description	Pack	
S02000015	Kit Sensor + Flow meter adapter cable L= 2,0 m PLUG-WIRES	1	
S02000016	Kit Sensor + Flow meter adapter cable L= 2,0 m PLUG-PLUG	1	
C00902104	Flow meter adapter cable L= 2,0 m PLUG-WIRES	1	
C00902105	Connecting cable for L = 2,0 m PLUG+PLUG	1	
NEW C00902135	Flow meter adapter cable L= 0,5 m PLUG-SUPER SEAL	1	
S02000014	Flowmeter sensor assembly	Output 1	
8404017	Rapid Fan turbine 1"	1	

DIMENSIONS NRG

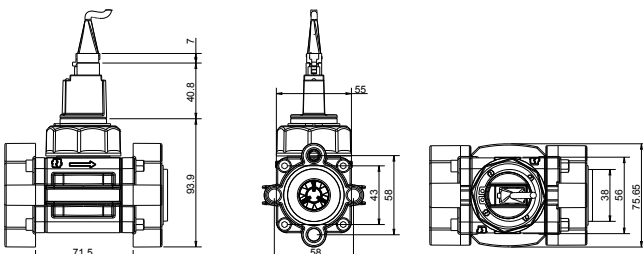

DIMENSIONS AF

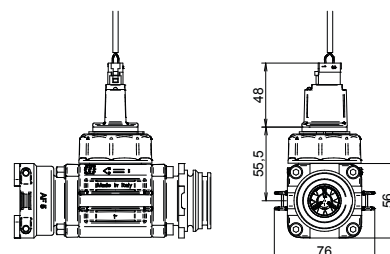

Electromagnetic Flowmeter



Flussometro elettromagnetico

- Per applicazioni agricole, industriali, nautiche, mobili, ecc..
- Di facile installazione e manutenzione;
- Affidabile;
- Completo di flange d'accoppiamento NRG Geoline 1";
- Corpo in poliarilammide rinforzato con fibra di vetro;
- Alimentazione 9-32 V DC;

Uscita: NPN Open Collector (Max 200 mA)
Precisione: minore o Uguale 1% FSO

Electromagnetic Flowmeter

- For agricultural, industrial, nautical, mobile, etc. applications.
- Easy to install and maintain;
- Reliable;
- Complete with NRG Geoline 1" coupling flanges;
- Glass fibre reinforced polyarylamide body;
- 9-32 V DC power supply;

Outlet: NPN Open Collector (Max 200 mA)
Precision: less or equal to 1% FSO

Débitmètre électromagnétique

- Pour des applications agricoles, industrielles, nautiques, mobiles, etc.
- Installation et entretien faciles;
- Fiable;
- Équipé de brides d'accouplement NRG Geoline 1";
- Corps en polyarylamide renforcée avec fibre de verre;
- Alimentation 9-32 V CC;

Sortie: NPN collecteur ouvert (max. 200 mA)
Précision: inférieure ou égale 1 % FSO



Part No.	I/I'	bar	% FSO	°C	V dc	Pack
8404023	3÷60	50	≤ 1	0 → +70	9 - 32	~0,6 1
8404024	5÷100	50	≤ 1	0 → +70	9 - 32	~0,6 1
8404025	10÷200	50	≤ 1	0 → +70	9 - 32	~0,6 1

Use



Obbligatorio ordinare separatamente.
Compulsory: to be ordered separately.
Obligatoire: commander séparément.

Part No.	Description	Pack
C00902104	Flow meter adapter cable L= 2,0 m PLUG-WIRES	1
C00902105	Connecting cable for L = 2,0 m PLUG+PLUG	1
NEW C00902135	Flow meter adapter cable L= 0,5 m PLUG-SUPER SEAL	1

DIMENSIONS

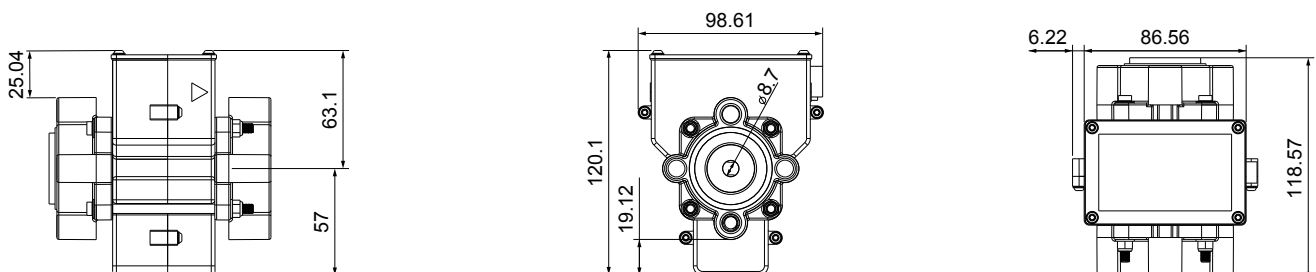

Electromagnetic Flowmeter

AF
FORK

NEW



Flussometro elettromagnetico

- Per applicazioni agricole, industriali, nautiche, mobili, ecc..
- Di facile installazione e manutenzione;
- Affidabile;
- Completo di flange d'accoppiamento NRG Geoline 1";
- Corpo in poliarilammide rinforzato con fibra di vetro;
- Alimentazione 9-32 V DC;

Uscita: NPN Open Collector (Max 200 mA)
Precisione: minore o Uguale 1% FSO.

Attacco a forchetta.

Electromagnetic Flowmeter

- For agricultural, industrial, nautical, mobile, etc. applications.
- Easy to install and maintain;
- Reliable;
- Complete with NRG Geoline 1" coupling flanges;
- Glass fibre reinforced polyarylamide body;
- 9-32 V DC power supply;

Outlet: NPN Open Collector (Max 200 mA)
Precision: less or equal to 1% FSO.

Fork couplings.

Débitmètre électromagnétique

- Pour des applications agricoles, industrielles, nautiques, mobiles, etc.
- Installation et entretien faciles;
- Fiable;
- Équipé de brides d'accouplement NRG Geoline 1";
- Corps en polyarylamide renforcée avec fibre de verre;
- Alimentation 9-32 V CC;

Sortie: NPN collecteur ouvert (max. 200 mA)
Précision: inférieure ou égale 1 % FSO.

Raccords à fourche.

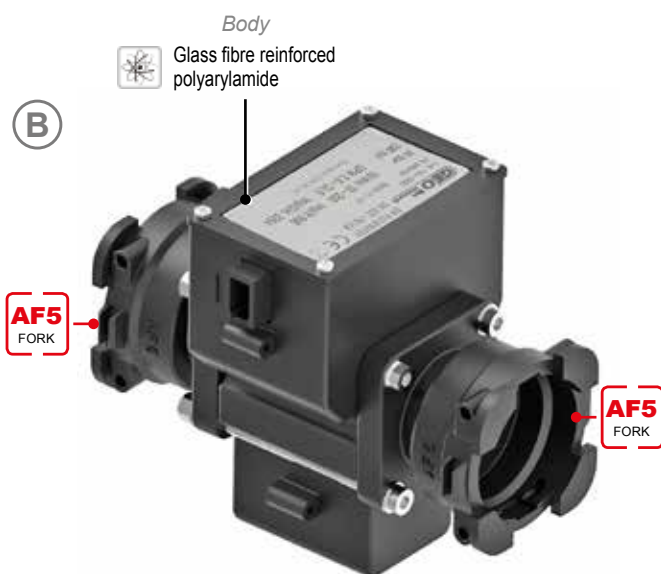
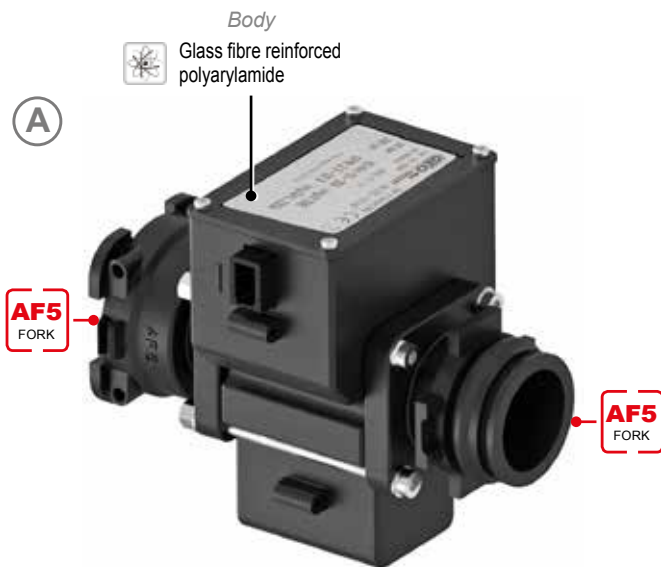

Part No.	Type	I/I'	bar	% FSO	°C	V dc	Pack
A 8404030	F - M	5÷100	50	≤ 1	0 → +70	9 - 32	~0,6 1
A 8404031	F - M	10÷200	50	≤ 1	0 → +70	9 - 32	~0,6 1
B 8404032	F - F	5÷100	50	≤ 1	0 → +70	9 - 32	~0,6 1
B 8404033	F - F	10÷200	50	≤ 1	0 → +70	9 - 32	~0,6 1

Use



Obbligatorio ordinare separatamente.
Compulsory: to be ordered separately.
Obligatoire: commander séparément.

Part No.	Description	Pack
C00902104	Flow meter adapter cable L= 2,0 m PLUG-WIRES	1
C00902105	Connecting cable for L = 2,0 m PLUG+PLUG	1
NEW C00902135	Flow meter adapter cable L= 0,5 m PLUG-SUPER SEAL	1

Filtri in linea flangiati con spurgo per gruppi di comando manuali ed elettrici serie NRG.

Flanged line filters with drain valve for manual and electric control units.

Filtres en ligne bridés et avec vanne de nettoyage pour groupes de commande manuels et électriques.

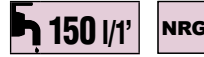
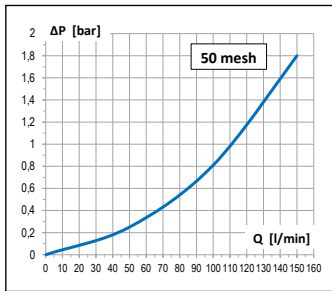

Part No.	bar	l/1'	Type	Screen	Screen Material	Pack
8124004	20	150	Standard	50 mesh	INOX	1
8124005				80 mesh		
8125010	20	150	Self Cleaning	50 mesh		
8125011				80 mesh		

SPARE PARTS

Part No.	Screen Mesh	Screen Material	Pack
C00100004	32	INOX	1
C00100005	50		
C00100006	80		
C00100007	100		

Part No.	Gasket	Material
G00001024	O-Ring	EPDM

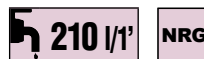
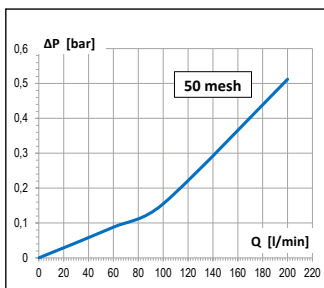

Part No.	bar	l/1'	Type	Screen	Screen Material	Pack
8124006	15	210	Standard	50 mesh	INOX	1
8124007				80 mesh		
8125012	15	210	Self Cleaning	50 mesh		
8125013				80 mesh		

SPARE PARTS

Part No.	Screen Mesh	Screen Material	Pack
C00100032	32	INOX	1
C00100033	50		
C00100034	80		
C00100035	100		

Part No.	Gasket	Material
G00001046	O-Ring	EPDM

Gruppo per atomizzatore 2 vie a pressione costante, composto da 2 elettrovalvole a solenoide e valvola manuale di regolazione pressione.

Uscita: G1/2" - Ingresso: 3/4"

Ideale per applicazioni su atomizzatori e gruppi irroranti.

Da completare con i relativi cavi elettrici e scatola di comando.

2-way Control unit for orchard sprayers at constant pressure with 2 solenoid valves and pressure relief manual valve.

1/2" BSP outlet and 3/4" BSP inlet

Perfect for applications on orchard sprayers and spraying machines.

To complete please order connecting cables and control panel.

Groupe de commande à 2 voies et pression constante pour atomiseur, composé par 2 vannes électriques à solénoïde et vanne manuelle de pression maxi.

Sortie : 1/2" BSP - Entrée: 3/4" BSP

Indiquée pour applications sur atomiseurs.

A compléter avec câble de branchement et boîtier de commande.



Part No.	Valves	l/1'	bar	°C	V dc	Pack
8378021	2	150	40	60	12	1

DIMENSIONS

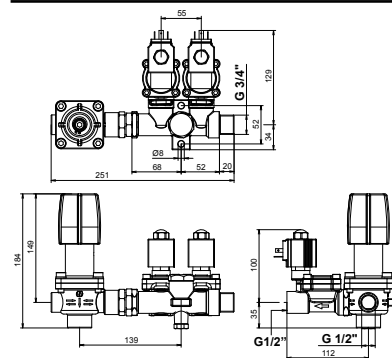

NEW

INTERNAL DESIGN



OPTIONALS



Pag. 326 Pag. 118 Pag. 40

Gruppo per atomizzatore 4 vie a pressione costante, composto da 4 elettrovalvole a solenoide e valvola manuale di regolazione pressione.

Uscita: G1/2" - Ingresso: 3/4"

Ideale per applicazioni su atomizzatori e gruppi irroranti.

Da completare con i relativi cavi elettrici e scatola di comando.

4-way Control unit for orchard sprayers at constant pressure with 4 solenoid valves and pressure relief manual valve.

1/2" BSP outlet and 3/4" BSP inlet

Perfect for applications on orchard sprayers and spraying machines.

To complete please order connecting cables and control panel.

Groupe de commande à 4 voies et pression constante pour atomiseur, composé par 4 vannes électriques à solénoïde et vanne manuelle de pression maxi.

Sortie : 1/2" BSP - Entrée: 3/4" BSP

Indiquée pour applications sur atomiseurs.

A compléter avec câble de branchement et boîtier de commande.



Part No.	Valves	l/1'	bar	°C	V dc	Pack
8378022	4	150	40	60	12	1

DIMENSIONS

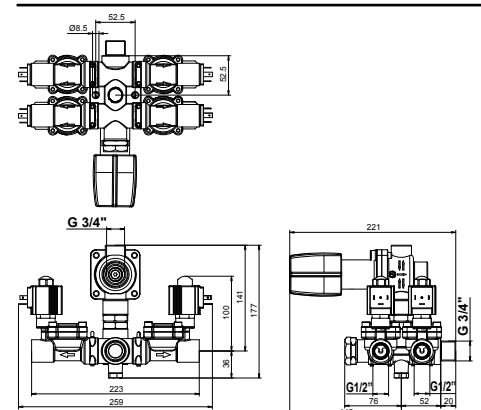

NEW

INTERNAL DESIGN

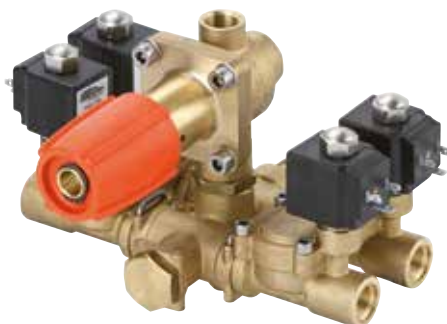

OPTIONALS



Pag. 326 Pag. 118 Pag. 40

Gruppo per atomizzatore 2 vie a pressione costante, composto da 2 elettrovalvole a solenoide, valvola manuale di regolazione pressione e filtro. Uscita: G1/2 - Ingresso: G3/4
Ideale per applicazioni su atomizzatori e gruppi irroranti.
Da completare con i relativi cavi elettrici e scatola di comando.

2-way Control unit for orchard sprayers at constant pressure with 2 solenoid valves, pressure relief manual valve and filter.
1/2" BSP outlet and 3/4" BSP inlet
Perfect for applications on orchard sprayers and spraying machines.
To complete please order connecting cables and control panel.

Groupe de commande à 2 voies et pression constante pour atomiseur, composé par 2 vannes électriques à solénoïde vanne manuelle de pression maxi et filtre.
Sortie : 1/2" BSP - Entrée: 3/4" BSP
Indiquée pour applications sur atomiseurs.
A compléter avec câble de branchement et boîtier de commande.

NEW
INTERNAL DESIGN



OPTIONALS



Pag. 326



Pag. 118



Pag. 40



Part No.	Valves	l/1'	bar	°C	V dc	Pack
8378023	2	150	40	60	12	1

DIMENSIONS

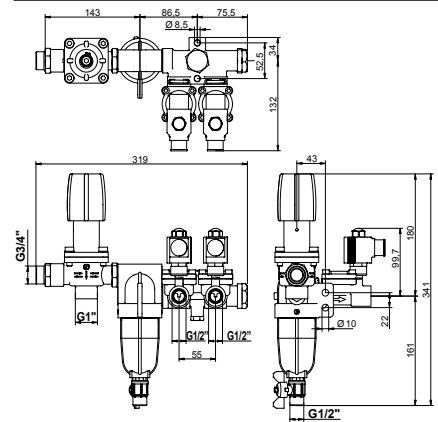

Elettrovalvola a solenoide MY18

Ideale per applicazioni su atomizzatori e gruppi irroranti.
Ideale per assemblaggi modulari.
Da completare con i relativi cavi elettrici e scatola di comando.

Electric Solenoid Valve MY18

Perfect for applications on orchard sprayers
Ideal for modular assembling
To complete please order connecting cables and control panel.

Vanne électrique à solénoïde MY18

Indiquée pour applications sur atomiseurs
Idéal pour assemblage modulaire
A compléter avec câble de branchement et boîtier de commande.



Part No.	l/1'	bar	°C	V dc	Pack
8388027	80	20	60	12	1
8388030	80	40	60	12	1

NEW
NEW

NEW
INTERNAL DESIGN



Part No.	l/1'	bar	°C	V dc	Pack
8388028	80	20	60	12	1
8388031	80	40	60	12	1

NEW
NEW

Ingresso: attacco rapido - Uscita: G1/2
Inlet: QUICK fitting - Outlet: 1/2" BSP
Entrée: raccord QUICK - Sortie: 1/2" BSP

OPTIONALS



Pag. 118

Ingresso / Uscita: G1/2
1/2" BSP Inlet and Outlet
Entrée et Sortie : 1/2" BSP



DIMENSIONS

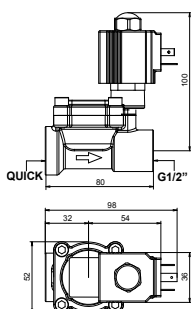

DIMENSIONS

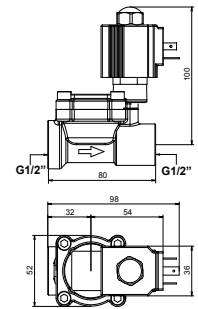

Accessori per elettrovalvole a solenoide

Solenoid valves accessories

Accessoires pour vannes électriques à solénoïde

Part No.	Type
1 8304058	G 3/4
2 8304057	G 3/4 M- G 3/4 M
3 8304000	G 3/4 M
4 R00000106	G 1/2 F - QUICK
5 T00000031	G 1/4 M



Part No.	Valves
6 C00601006	2
6 C00601007	4



Part No.	Material
7 F00000016	INOX
8 G00001059	VITON
9 G00002025	VITON



OR 130



INSTALLATION

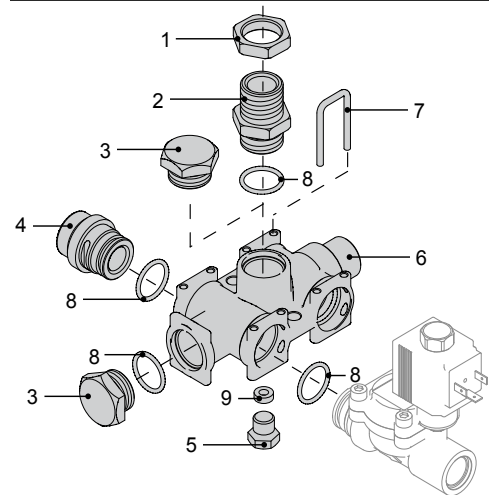

Cavo di alimentazione per valvole elettriche a solenoide, completo di guarnizione e vite di fissaggio.
Dotato di led segnalazione valvola aperta.

Power supply cable for solenoid valves with fittings and screw.
Open valve led indicator included.

Câble de branchement pour vannes électriques à solénoïde avec joint et vis de fixation.
Équipé d'un diode indiquant que la vanne est ouverte.



Part No.	L mm	°C	V dc	Pack
C00900021	1500	60	12	1

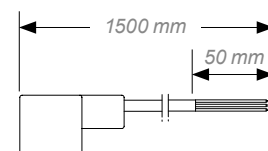

Tracciafile GFM 25

- Compressore a membrana con motore elettrico.
- Cofano compressore in ABS rosso.
- Serbatoio in polietilene da 24 L ad alta resistenza. Tappo serbatoio completo di regolatore di flusso con all'interno valvola di sicurezza in plastica tarata fissa a 0,7 bar e valvola di non ritorno, a membrana ad alta sensibilità.
- Tubazione aria-liquido con tubi in polietilene 6x4 ricoperti di morbida guaina.
- Spruzzatori verticali da 150 mm per l'erogazione della schiuma, con supporti regolabili e diffusori per aumentare la dimensione e durata della schiuma sul terreno.
- Scatola con interruttore di comando elettrico, lampade di indicazione lato funzionamento e fusibile di protezione.
- Cavo alimentazione da 2 m con presa e spina, cavo collegamento al compressore da 5 m.
- Utilizzabile con radiocomandi serie GeoCrop.

Foam marker GFM 25

- Diaphragm compressor with electric motor
- Compressor casing in red ABS.
- High resistant polyethylene tank of 24 lt with flow regulator.
- Pre-setted safety valve (0.7 bar) and diaphragm check valve.
- Air & Liquid polyethylene pipings of 6x4 mm with soft rubber protection hose.
- Vertical foam spreaders of 150 mm length with adjustable supports and diffusers to increase foam volume and life on the ground.
- Box with electrical control switch, warning lamp on the running side and protection fuse.
- 2m feeding cable with outlet and plug, 5m connecting cable to the compressor.
- Can be used with the GeoCrop series of remote controls.

Traceur à mousse GFM 25

- Compresseur à membrane avec moteur électrique.
- Capot en ABS de couleur rouge.
- Réservoir en polyéthylène de 24 lt haute résistance. Clapet de sécurité.
- Vanne de sécurité calibrée fixe à 0,7 bar avec vanne de non-retour.
- Tuyaux air/liquide en polyéthylène de 6x4mm avec gaine de protection.
- Tuyau vertical de 150 mm avec supports réglables et diffuseurs pour augmenter la durée et le volume de la mousse sur le terrain.
- Boîte avec interrupteur de commande électrique, témoins d'indication côté fonctionnement et fusibles de protection.
- Câble d'alimentation de 2 m avec prise et fiche, câble connexion au compresseur de 5 m.
- Utilisable avec commande radio série GeoCrop.

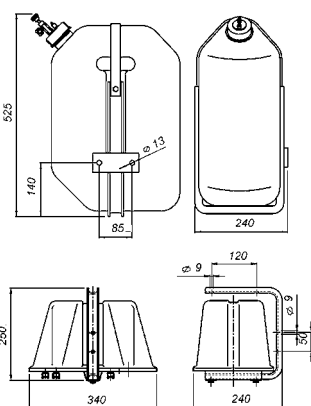

Part No.	°C	V dc	Pack
8394014	60	12	1

Kit per il collegamento di un tracciafile ad un computer o ad una scatola idraulica di comando.

Wiring kit to connect a foam marker to a computer or to a hydraulic control box.

Kit de branchement du traceur à mousse à boîtier électrique ou bien à une boîte de commande hydraulique.



Fino ad esaurimento
Selling out
Jusqu'à épuisement

Part No.	°C	V dc	Type	Pack
A 8394007	60	12	standard	1
B 8394016	60	12	GeoSystem	1

B Adatto per / Suitable to / Appropriate à

GS 260 CS	GS 250 CS	GS 200
GS 260 CS H	GS 250 CS H	

Schiumogeno

È un prodotto di buona qualità, inerte, con maggiore permanenza sul terreno e buona visibilità.

Foaming agent

Good quality inert foaming agent. It generates a long standing and highly visible foam.

Produit moussant

Produit moussant inerte de bonne qualité qui donne une masse mousseuse durable et bien visible.



200 kg



25 kg



5 kg

Part No.	Color	Contents	Type	Pack
8394008	PINK	kg 5 - Lb 11,1	standard	4
8394009	BROWN	kg 5 - Lb 11,1	long lasting	4
8394003	PINK	kg 25 - Lb 55,5	standard	1
8394004	BROWN	kg 200 - Lb 440	long lasting	1

GEOPUMP



Pompa elettrica 12V ad ingranaggi

Gears electric pump 12V

Pompe électrique 12V avec engrenages



Gears - BRASS

Part No.	l/1'	bar	m	°C	Kg	V dc	A	Pack
8411018	12,0	3,5	3	60	2,68	12	10,0	1

DIMENSIONS

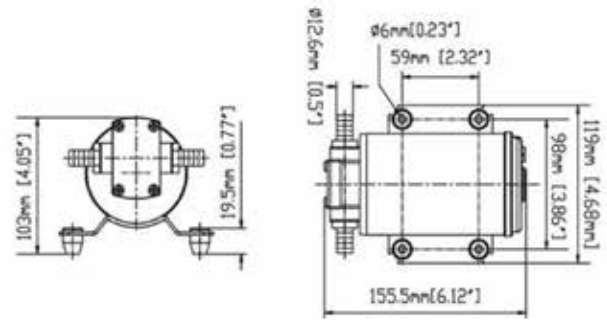



OPTIONALS



Pag. 36

Composizione del kit Kit composed of / Composition de kit

Description	Q.ty
GeoPump 	1
Hosetail  Ø 14,5 mm G 3/8	2

GEOPUMP



Pompa elettrica 12V / 24V

Caratteristiche

ingresso/uscita attacco rapido
Per uso intermittente (30 min. on - 30 min. off).
4 pompanti a membrana, auto adescante, può funzionare a secco
Valvole in Viton® , membrana in TPE.

Applicazioni

- Agricole
- Irrorazione
- Industriali
- Automotive (caravan)
- Marine

Electric Pump 12V / 24V

Features

Quick lock ports.
For intermittent periodic duty cycles (30 min. on - 30 min. off).
4 chamber diaphragm pump, self priming, it runs dry.
Viton® valves, TPE diaphragm.

Applications

- Agriculture
- Spraying
- Industry
- Automotive
- Marine

Pompe électrique 12V / 24V

Orifices à fermeture rapide.

Pour des cycles de service intermittents périodiques (30 min. ON - 30 min. OFF).
Pompe à diaphragme 4 chambres, à amorçage automatique, fonctionne à sec.
Vannes Viton®, diaphragme TPE.

Applications

- Agriculture
- Pulvérisation
- Industrie
- Automobile
- Marine.



Quick lock ports



Part No.	l/1'	bar	m	°C	Kg	V dc	A	Pack
8411021	17,0	2,8	1,8	60	2,3	12	15,0	1
8411022	17,0	2,8	1,8	60	2,3	24	6,0	1

DIMENSIONS

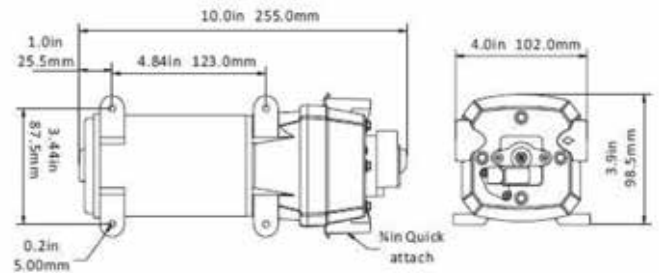

OPTIONALS



Pag. 36

Composizione del kit

Kit composed of / Composition de kit

Description		Q.ty
GeoPump		1
Inlet filter	40 Mesh Ø 12,5 mm	1
90° hoesetail	Ø 12,5 mm	2
Hoesetail	Ø 12,5 mm	2

GEOPUMP



Pompa elettrica 12V / 24V

Caratteristiche

ingresso/uscita attacco rapido
Per uso intermittente (30 min. on - 30 min. off).
4 pompanti a membrana, auto adescante, può funzionare a secco
Valvole in Viton® , membrana in TPE.

Applicazioni

- Agricole
- Irrorazione
- Industriali
- Automotive (caravan)
- Marine

Electric Pump 12V / 24V

Features

Quick lock ports.
For intermittent periodic duty cycles (30 min. on - 30 min. off).
4 chamber diaphragm pump, self priming, it runs dry.
Viton® valves, TPE diaphragm.

Applications

- Agriculture
- Spraying
- Industry
- Automotive
- Marine

Pompe électrique 12V / 24V

Orifices à fermeture rapide.
Pour des cycles de service intermittents périodiques (30 min. ON - 30 min. OFF).
Pompe à diaphragme 4 chambres, à amorçage automatique, fonctionne à sec.
Vannes Viton®, diaphragme TPE.

Applications

- Agriculture
- Pulvérisation
- Industrie
- Automobile
- Marine.



Quick lock ports



Part No.	l/1'	bar	m	°C	Kg	V dc	A	Pack
8411019	12,5	2,4	1,8	60	1,8	12	8,0	1
8411020	12,5	2,4	1,8	60	1,8	24	4,0	1

DIMENSIONS

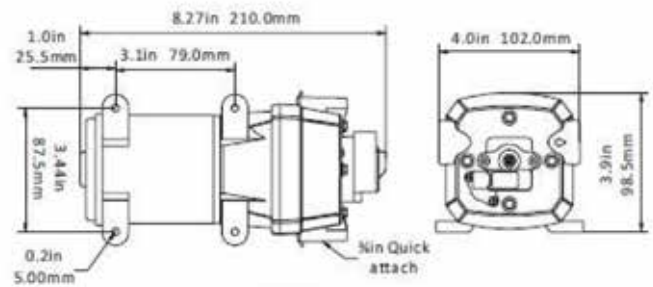

OPTIONALS



Pag. 36

Composizione del kit

Kit composed of / Composition de kit

Description		Q.ty
GeoPump		1
Inlet filter	40 Mesh Ø 12,5 mm	1
90° hosetail	Ø 12,5 mm	2
Hosetail	Ø 12,5 mm	2

GEOPUMP



Pompa elettrica 12V

Caratteristiche

ingresso/uscita 3/8" NPT.
3 pompanti a membrana, auto adescante, può funzionare a secco
Valvole in Viton® , membrana in TPE.

Per uso continuo.

Applicazioni

- Agricole
- Irrorazione
- Industriali
- Automotive (caravan)
- Marine

Electric Pump 12V

Features

Hosetails 3/8" NPT.
3 chamber diaphragm pump, self priming, it runs dry.
Viton® valves, TPE diaphragm.

For continuous duty cycle.

Applications

- Agriculture
- Spraying
- Industry
- Automotive (caravan)
- Marine

Pompe électrique 12V

Caractéristiques

Raccords 3/8" NPT.
Pompe à diaphragme 3 chambres, à amorçage automatique, fonctionne à sec.
Vannes Viton®, diaphragme TPE.

Pour cycle de service continu.

Applications

- Agriculture
- Pulvérisation
- Industrie
- Automobile (caravan)
- Marine



Part No.	l/1'	bar	m	°C	Kg	V dc	A	Pack
8411000	5,5	5,5	1,8	60	2,6	12	8,0	1
8411017	5,5	6,9	1,8	60	2,6	12	8,5	1

DIMENSIONS

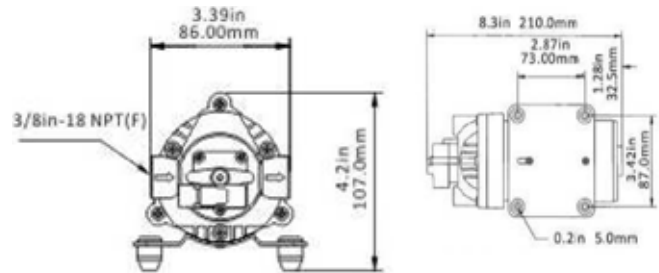



OPTIONALS



Pag. 36

Composizione del kit

Kit composed of / Composition de kit

Description	Q.ty
GeoPump 	1
Hosetail 3/8" NPT 	2

GEOPUMP



Pompa elettrica 12V

Caratteristiche

ingresso/uscita attacco rapido
Per uso intermittente (30 min. on - 30 min. off).
2 pompanti a membrana, auto adescante, può funzionare a secco
Valvole in Viton® , membrana in TPE.

Applicazioni

- Agricole
- Irrorazione
- Industriali
- Automotive (caravan)
- Marine

Electric Pump 12V

Features

Hosetails 3/8".
For intermittent periodic duty cycles (30 min. on - 30 min. off).
2 chamber diaphragm pump, self priming, it runs dry.
Viton® valves, TPE diaphragm.

Applications

- Agriculture
- Spraying
- Industry
- Automotive (caravan)
- Marine

Pompe électrique 12V

Caractéristiques

Raccords 3/8" NPT.
Pour des cycles de service intermittents périodiques (30 min. ON - 30 min. OFF).
Pompe à diaphragme 2 chambres, à amorçage automatique, fonctionne à sec.
Vannes Viton®, diaphragme TPE.

Applications

- Agriculture
- Pulvérisation
- Industrie
- Automobile (caravan)
- Marine



Part No.	l/1'	bar	m	°C	Kg	V dc	A	Pack
8411002	3,8	2,4	1,2	43	0,57	12	2,5	1

DIMENSIONS

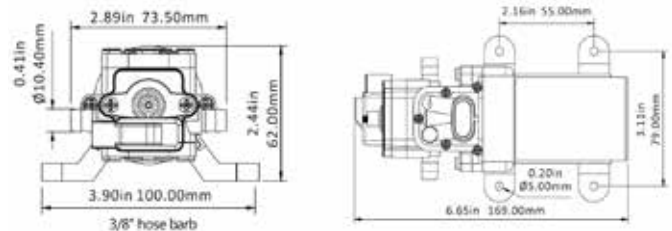

OPTIONALS



Pag. 36

Composizione del kit

Kit composed of / Composition de kit

Description	Q.ty
GeoPump 	1

Valvola di regolazione manuale di massima pressione.

Manual adjustable pressure relief valve.

Vanne réglable manuelle de pression maxi.

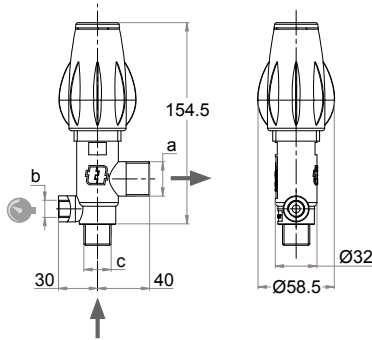
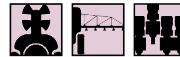

Part No.	l/1'	bar	a	b	c	by-pass	°C	Pack
8384043	70	4	G 3/4 M	G 1/4 F	G 1/2 M	60	10	10
8384045								
8384044		10	G 3/4 M	G 1/4 F	G 1/2 M			
8384046					G 3/4 M			



Part No.	l/1'	bar	a	b	c	by-pass	°C	Pack
8384050	70	4	3/4 - 14 NPT	1/4 - 18 NPT	3/4 - 14 NPT	1/2 - 14 NPT	60	1
8384052						3/4 - 14 NPT		
8384051		10	1/2 - 14 NPT					

OPTIONALS



Pag. 326

Dispositivo di limitazione della pressione

Il dispositivo è stato realizzato nel rispetto della normativa europea che prevede il ritorno in cisterna del liquido fuoriuscito e il non superamento della pressione nominale dell'impianto del 20%. E' dotato di raccordo girevole che ne facilita il montaggio e di sigillo antimanomissione.

Il dispositivo deve essere assemblato su pompe facenti parte di sistemi complessi o venduto come ricambio originale di pompe per macchine irroratrici.

Pressure cut-off device

This device is manufactured in accordance with the EN standard, limiting overpressure to 20% more than working pressure, by-passing exceeding liquid to the tank. Easy to assemble thanks to the swivel inlet fitting and also provided with anti-tampering device.

This device must be fitted on pumps assembled on a complete spraying machine or can be sold as original spare part of the same kind of pump.

Dispositif limitant la pression

Ce dispositif est réalisé en respect de la norme EN : il maintient la pression nominale dans la limite de plus 20%, en retournant le liquide écoulé dans la citerne. Simple à assembler grâce au raccord tournant et doté de plombage anti-manipulation.

Ce dispositif doit être assemblé sur pompes faisant partie d'une machine d'irrotation complète ou peut être vendu comme pièce de rechange originale pour le même type de pompe.

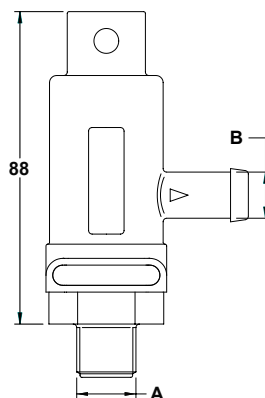

Part No.	l/1'	bar	°C	A	B	Ø mm	Pack
8300000	20+100	10	60	G 3/8	13	13	5
8300001		20					
8300002		30					
8300003		40					
8300004	100+200	50	60	G 1/2	19	19	5
8300005		10					
8300006		20					
8300007	100+150	50	60	G 1/2	19	19	5
8300011		50					
8300008	200+300	10	60	G 3/4	25	25	5
8300009		20					
8300012	150+260	50	60	G 3/4	25	25	5

ST/DRIVER

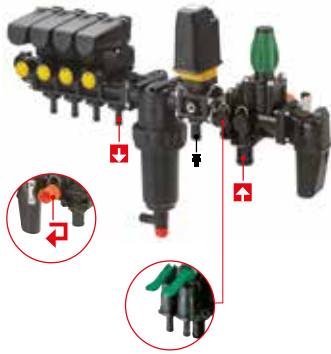

Part No.	Valves	IN		OUT				BY-PASS				
		Ø mm		Ø mm				Ø mm				
		19	25	10	13	16	19	19	35	35	35	G 1 M
850000	5		•		•							•
850003	5		•				•					•
850009	5		•	•								•
8500012	3	•				•		•				
8500002	4		•		•					•		
8500007	4	•					•		•			

ST/DRIVER 06

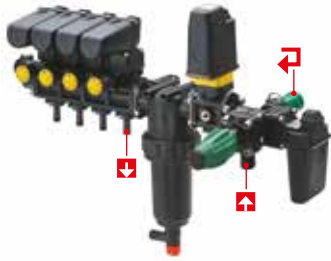

Part No.	Valves	IN		OUT				G 3/4 M	BY-PASS			
		Ø mm		Ø mm					Ø mm			
		19	25	10	13	16	25		19	25	35	35
8501040	3	•					•				•	
8501028	3		•		•							•
8501044	4	•		•				•				
8500008	5		•		•							•
8501002	5		•		•							•
8501049	6	•				•				•		
8501024	7		•	•						•		

DRIVER

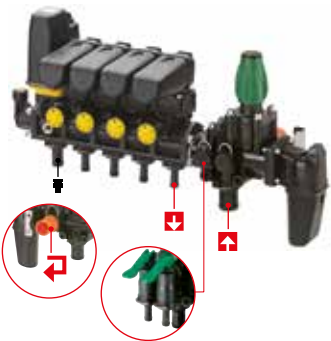

Part No.	Valves	IN		OUT				25	BY-PASS		
		Ø mm		Ø mm					Ø mm		
		19	25	10	13	16	19		35	35	35
8502009	3		•				•		•		
8502010	3		•	•			•				
8502005	3	•			•					•	
8502007	4		•				•				
8502014	4		•	•						•	
8502008	5		•				•		•		
8502019	5		•		•					•	
8502021	5		•	•						•	
8502018	6		•			•				•	
8502024	6		•		•					•	

DRIVER - 06

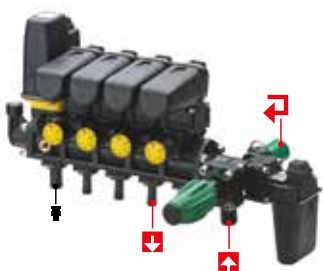

Part No.	Valves	IN		OUT				25	BY-PASS	
		Ø mm		Ø mm					Ø mm	
		19	25	10	13	16	19		35	35
8503034	4		•		•			•		
8503032	5		•	•				•		
8503031	5		•		•			•		
8503001	5		•		•				•	
8503035	6		•		•			•		

ST/BASIC 206

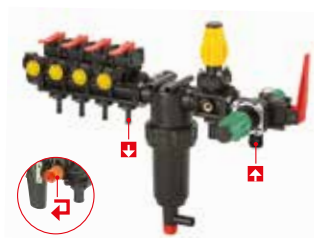

Part No.	Valves	IN		OUT			BY-PASS	
		Ø mm		Ø mm			Ø mm	
		25	10	13	19	25	35	
8519010	5	●		●			●	
8519012	5	●	●			●		
8519016	3	●		●		●		
8519023	3	●			●		●	
8519022	4	●	●			●		
8519004	6	●	●				●	

BASIC 206

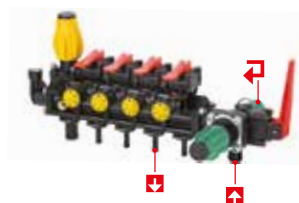

Part No.	Valves	IN		OUT			BY-PASS		
		Ø mm		Ø mm			Ø mm		
		19	25	10	13	25	35	35	G 1 M
8517037	3		●	●					●
8517028	3		●		●				●
8517044	3		●		●	●			
8517052	4		●		●		●		
8517057	4		●	●		●			
8517014	4	●			●			●	
8517034	5		●	●		●			
8517045	5		●		●	●			
8517031	5		●	●					●
8517056	7		●	●		●			

ST/START 06

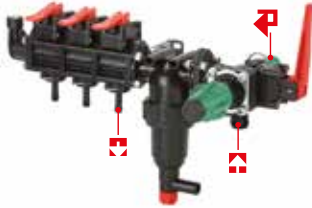

Part No.	Valves	IN		OUT			BY-PASS		
		Ø mm		Ø mm			Ø mm		
		19	25	10	13	19	25	35	35
8513011	3		●		●		●		
8513015	3		●			●	●		
8513032	3		●			●		●	
8512017	4	●		●				●	
8513012	4		●		●		●		
8513019	5		●		●		●		
8513024	5		●	●			●		
8513029	5		●			●	●		
8512018	6		●	●					●
8513017	6	●			●				●
8513025	6		●	●			●		

START 06

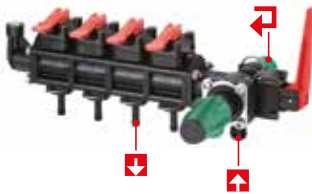

Part No.	Valves	IN		OUT			BY-PASS			
		Ø mm		Ø mm			Ø mm			
		19	25	10	13	25	35	35	35	G 1 M
8511006	3		●		●		●			
8511012	3		●	●		●				
8511018	3		●		●	●				
8511020	4		●	●						●
8511022	4		●	●					●	
8511029	6		●		●				●	
8511026	6	●			●			●		
8511059	5		●	●		●				
8511067	7		●	●		●				

START 08

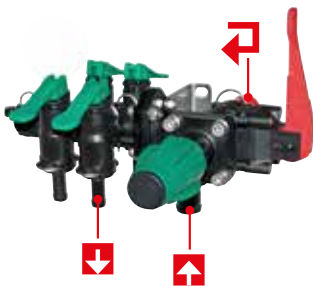

Part No.	Valves	IN		OUT		BY-PASS
		Ø mm		Ø mm		Ø mm
		19		13	19	G 1 M
8533030	4	●		●		●
8533029	4	●		●		●

ECOSTAR

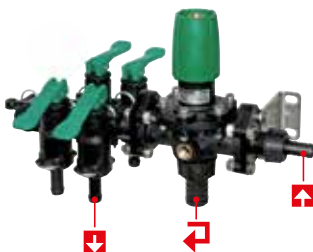

Part No.	Valves	IN		OUT	BY-PASS
		Ø mm		Ø mm	Ø mm
		25		10	19
8532004	4	●		●	●

w w w . g e o l i n e . i t



LEGENDA

Caratteristiche / Features / Caracteristiques

 Pressione d'esercizio
Operating pressure
Pression de service

 Temperatura max
Max temperature
Temperature maxi

FEATURES

 **60°C**
Massima temperatura di esercizio
Maximum operating temperature
Température de fonctionnement maximale

VALVOLE A SFERA

BALL VALVES / VANNES À BILLES

2

Valvole a sfera

Le valvole a sfera GEOLINE vengono realizzate in polipropilene, con guarnizioni in EPDM (Viton® a richiesta), particolari metallici esterni di fissaggio in ottone.

Ball valves

GEOLINE ball valves are in polypropylene, with EPDM gaskets (Viton® on demand), external fastening brass details.

Vannes à billes

Les vannes à billes GEOLINE sont en polypropylène, avec joints en EPDM (Viton® sur demande), dispositifs de fixation extérieurs en laiton.



Valvola a sfera 2 vie

- Struttura in polipropilene rinforzato con fibra di vetro per una maggiore robustezza e resistenza chimica.
- Sedi in Teflon garantiscono una facile maneggevolezza ed una buona tenuta.
- Guarnizioni in EPDM per trattamenti con fertilizzanti e agenti chimici. Viton® disponibile su richiesta.
- Pressione di lavoro per dimensioni fino a 1"1/4 PN 16, per dimensioni superiori PN 10;
- Disponibile anche in versione per montaggio a pannello (PM).

2-ways ball valve

- Fiberglass reinforced polypropylene body for strength and chemical resistance.
- Teflon seats for smooth operation and proper sealing characteristics.
- EPDM o-rings to handle most fertilizers and chemicals. Viton® on demand.
- Max operating pressure for sizes up to 1"1/4 PN 16 (232 PSI). For bigger sizes PN10 (145 PSI);
- Available also in panel mounting version (PM).

Vanne à bille 2 voies

- Corps en polypropylène renforcé par fibres de verre pour garantir une grande robustesse et une bonne résistance aux produits chimiques.
- Sièges en Teflon qui garantissent une maniabilité et une étanchéité optimale.
- Joints en EPDM pour l'usage de la plus part de fertilizants et de produits chimiques. Viton® sur demande.
- Pression de travail pour dimensions jusqu'à 1"1/4 PN 16, pour dimensions supérieures PN 10;
- Disponible aussi en version pour montage sur panneau (PM).

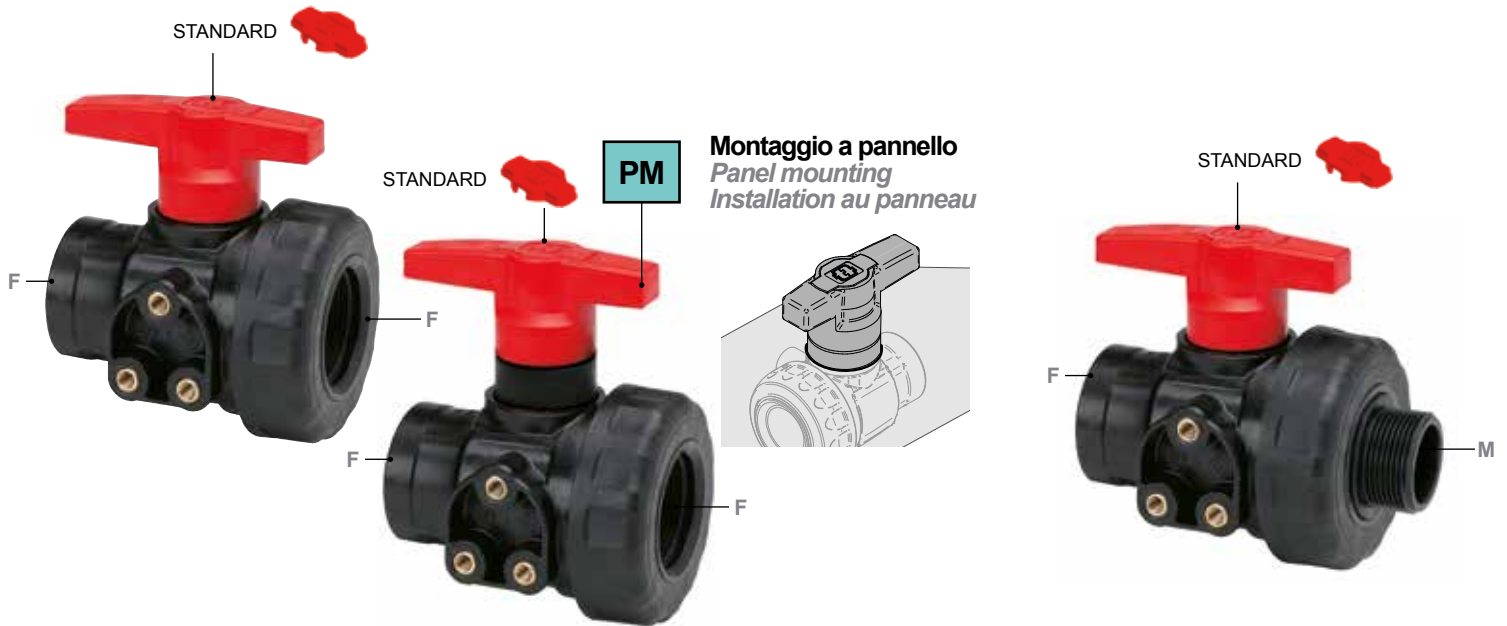

STD	PM						
Part No.	Part No.	F	Lever	°C	bar	Type	Pack
8215102	-	G 3/8"	FF LL	60 ⇄ 16	-	-	10
8215153	8217151	G 1/2"	FF LL	60 ⇄ 16	-	-	10
8215203	8217201	G 3/4"	FF LL	60 ⇄ 16	-	-	10
8215253	8217251	G 1"	FF LL	60 ⇄ 16	1	10	10
8215303	8217301	G 1"1/4	FF LL	60 ⇄ 10	1	10	10
8215353	8217351	G 1"1/2	FF LL	60 ⇄ 10	2	10	10
8215403	8217401	G 2"	FF LL	60 ⇄ 10	2	10	10
8215305	-	G 1"1/4	FF LC	60 ⇄ 10	1	10	10
8215355	-	G 1"1/2	FF LC	60 ⇄ 10	2	10	10
8215405	-	G 2"	FF LC	60 ⇄ 10	2	10	10

PM = Panel Mounting **FF**= Female/Female
LL= Long Lever **LC**= Short Lever

Part No.	F	Lever	°C	bar	Type	Pack
8215257	G 1"	MF LL	60 ⇄ 16	1	10	10
8215307	G 1"1/4	MF LL	60 ⇄ 10	1	10	10
8215357	G 1"1/2	MF LL	60 ⇄ 10	2	10	10
8215407	G 2"	MF LL	60 ⇄ 10	2	10	10
8215309	G 1"1/4	MF LC	60 ⇄ 10	1	10	10
8215359	G 1"1/2	MF LC	60 ⇄ 10	2	10	10
8215409	G 2"	MF LC	60 ⇄ 10	2	10	10

MF= Male/Female **LL**= Long Lever **LC**= Short Lever

Flusso ON-OFF
ON-OFF flow
Passage ON-OFF



Valvola a sfera a 3 vie - ON-OFF e FLUSSO CONTINUO

- Evita l'innalzamento brusco della pressione durante la deviazione da una via all'altra.
- Struttura in polipropilene rinforzato con fibra di vetro per una maggiore robustezza e resistenza chimica.
- Sedi in Teflon garantiscono una facile maneggevolezza ed una buona tenuta.
- Guarnizioni in EPDM per trattamenti con fertilizzanti e agenti chimici. Viton® disponibile su richiesta.
- Pressione di lavoro per dimensioni fino a 1" PN 16, per dimensioni superiori PN 10.
- Filettature NPT a richiesta;
- Disponibile anche in versione per montaggio a pannello (PM).

3-ways ball valve - ON-OFF and CONTINUOUS FLOW

- To prevent overpressure when, selecting directional flow, the valve cannot be turned off.
- Fiberglass reinforced polypropylene body for strength and chemical resistance.
- Teflon seats for smooth operation and proper sealing.
- EPDM o-rings to handle most fertilizers and chemicals. Viton® on demand.
- Max operating pressure for sizes up to 1" PN 16 (232 PSI). For bigger sizes PN10 (145 PSI).
- NPT threads on demand;
- Available also in panel mounting version (PM).

Vanne à bille 3 voies - ON-OFF et A PASSAGE CONTINUU

- Empêche à la pression de monter tout à coup quand on passe d'une voie à l'autre.
- Corps en polypropylène renforcé par fibres de verre pour garantir robustesse et résistance aux produits chimiques.
- Sièges en Teflon qui garantissent maniabilité et étanchéité optimale.
- Joints en EPDM pour l'usage de la plus part de fertilizants et de produits chimiques. Viton® sur demande.
- Pression de travail pour dimensions jusqu'à 1" PN 16, pour dimensions supérieures PN 10.
- Filetage NPT sur demande;
- Disponible aussi en version pour montage sur panneau (PM).

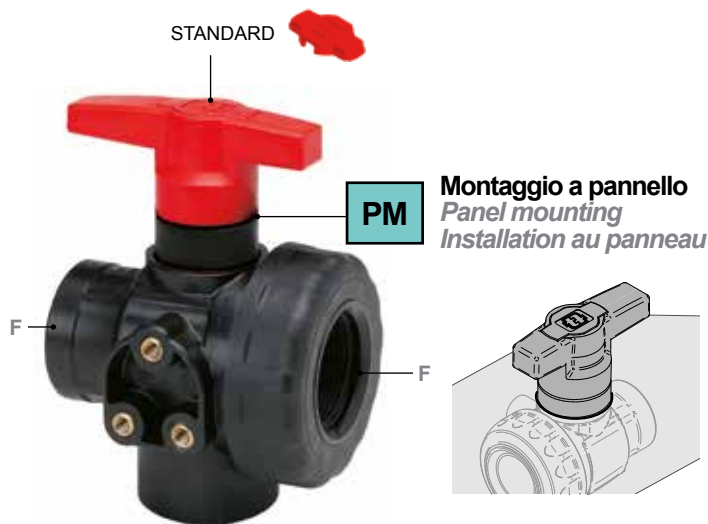

ON-OFF flow

STD	PM								
Part No.	Part No.	F	Lever	°C	bar	Type	Pack		
8216151	8218151	G 1/2" FF	LL	60	⇔ 16	-	10		
8216201	8218201	G 3/4" FF	LL	60	⇔ 16	-	10		
8216252	8218251	G 1" FF	LL	60	⇔ 16	1	10		
8216307	8218301	G 1 1/4" FF	LL	60	⇔ 10	1	10		
8216357	8218351	G 1 1/2" FF	LL	60	⇔ 10	2	10		
8216407	8218401	G 2" FF	LL	60	⇔ 10	2	10		
8216309	-	G 1 1/4" FF	LC	60	⇔ 10	1	10		
8216359	-	G 1 1/2" FF	LC	60	⇔ 10	2	10		
8216409	-	G 2" FF	LC	60	⇔ 10	2	10		

PM = Panel Mounting FF= Female/Female
LL= Long Lever LC= Short Lever

Continuous flow

STD	PM								
Part No.	Part No.	F	Lever	°C	bar	Type	Pack		
8216253	8218253	G 1" FF	LL	60	⇔ 16	1	10		
8216308	8218303	G 1 1/4" FF	LL	60	⇔ 10	1	10		
8216358	8218353	G 1 1/2" FF	LL	60	⇔ 10	2	10		
8216408	8218403	G 2" FF	LL	60	⇔ 10	2	10		
8216310	-	G 1 1/4" FF	LC	60	⇔ 10	1	10		
8216360	-	G 1 1/2" FF	LC	60	⇔ 10	2	10		
8216410	-	G 2" FF	LC	60	⇔ 10	2	10		

PM = Panel Mounting FF= Female/Female
LL= Long Lever LC= Short Lever

Flusso ON-OFF
ON-OFF flow
Passage ON-OFF

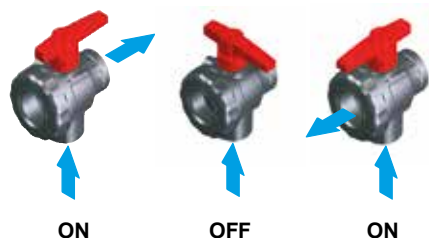

Flusso continuo
Continuous flow
A passage continuu

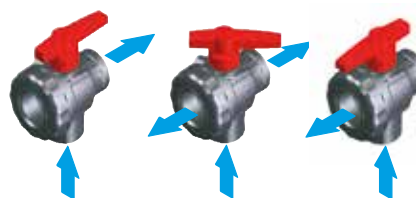

Valvola a sfera a 3 vie - ON-OFF e FLUSSO CONTINUO

- Evita l'innalzamento brusco della pressione durante la deviazione da una via all'altra;
- Struttura in polipropilene rinforzato con fibra di vetro per una maggiore robustezza e resistenza chimica;
- Sedi in Teflon garantiscono una facile maneggevolezza ed una buona tenuta;
- Guarnizioni in EPDM per trattamenti con fertilizzanti e agenti chimici. Viton® disponibile su richiesta;
- Pressione di lavoro per dimensioni fino a 1"1/4 PN 16, per dimensioni superiori PN 10;
- Filettature NPT a richiesta.

3-ways ball valve - ON-OFF and CONTINUOUS FLOW

- To prevent overpressure when, selecting directional flow, the valve cannot be turned off.
- Fiberglass reinforced polypropylene body for strength and chemical resistance.
- Teflon seats for smooth operation and proper sealing.
- EPDM o-rings to handle most fertilizers and chemicals. Viton® on demand.
- Max operating pressure for sizes up to 1"1/4 PN 16 (232 PSI). For bigger sizes PN10 (145 PSI).
- NPT threads on demand.

Vanne à bille 3 voies - ON-OFF et A PASSAGE CONTINUU

- Empêche à la pression de monter tout à coup quand on passe d'une voie à l'autre.
- Corps en polypropylène renforcé par fibres de verre pour garantir robustesse et résistance aux produits chimiques.
- Sièges en Teflon qui garantissent maniabilité et étanchéité optimale.
- Joints en EPDM pour l'usage de la plus part de fertilizants et de produits chimiques. Viton® sur demande.
- Pression de travail pour dimensions jusqu'à 1"1/4 PN 16, pour dimensions supérieures PN 10.
- Filetage NPT sur demande.



ON-OFF flow



Part No.	F	Lever	°C	bar	Type	Pack
8216256	G 1"	MF LL	60 ⇔ 16	1	10	
8216311	G 1"1/4	MF LL	60 ⇔ 10	1	10	
8216361	G 1"1/2	MF LL	60 ⇔ 10	2	10	
8216411	G 2"	MF LL	60 ⇔ 10	2	10	
8216313	G 1"1/4	MF LC	60 ⇔ 10	1	10	
8216363	G 1"1/2	MF LC	60 ⇔ 10	2	10	
8216413	G 2"	MF LC	60 ⇔ 10	2	10	

MF= Male/Female LL= Long Lever LC= Short Lever

Continuous flow



Part No.	F	Lever	°C	bar	Type	Pack
8216257	G 1"	MF LL	60 ⇔ 16	1	10	
8216312	G 1"1/4	MF LL	60 ⇔ 10	1	10	
8216362	G 1"1/2	MF LL	60 ⇔ 10	2	10	
8216412	G 2"	MF LL	60 ⇔ 10	2	10	
8216314	G 1"1/4	MF LC	60 ⇔ 10	1	10	
8216364	G 1"1/2	MF LC	60 ⇔ 10	2	10	
8216414	G 2"	MF LC	60 ⇔ 10	2	10	

MF= Male/Female LL= Long Lever LC= Short Lever

Flusso ON-OFF
ON-OFF flow
Passage ON-OFF

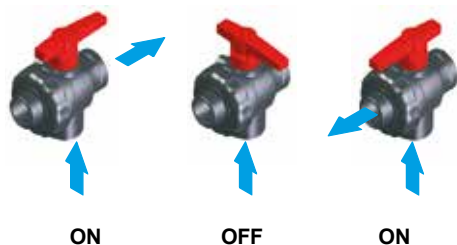

Flusso continuo
Continuous flow
A passage continuu



Valvola a sfera 2 vie

- Struttura in polipropilene rinforzato con fibra di vetro per una maggiore robustezza e resistenza chimica;
- Sedi in Teflon garantiscono una facile maneggevolezza ed una buona tenuta;
- Guarnizioni in EPDM per trattamenti con fertilizzanti e agenti chimici. Viton® disponibile su richiesta;
- Pressione di lavoro per dimensioni fino a 1"1/4 PN 16, per dimensioni superiori PN 10;
- Disponibile anche in versione per montaggio a pannello (PM).

2-ways ball valve

- Fiberglass reinforced polypropylene body for strength and chemical resistance.
- Teflon seats for smooth operation and proper sealing characteristics.
- EPDM o-rings to handle most fertilizers and chemicals. Viton® on demand.
- Max operating pressure for sizes up to 1"1/4 PN 16 (232 PSI). For bigger sizes PN10 (145 PSI);
- Available also in panel mounting version (PM).

Vanne à bille 2 voies

- Corps en polypropylène renforcé par fibres de verre pour garantir une grande robustesse et une bonne résistance aux produits chimiques.
- Sièges en Teflon qui garantissent une maniabilité et une étanchéité optimale.
- Joints en EPDM pour l'usage de la plus part de fertilizants et de produits chimiques. Viton® sur demande.
- Pression de travail pour dimensions jusqu'à 1"1/4 PN 16, pour dimensions supérieures PN 10;
- Disponible aussi en version pour montage sur panneau (PM).

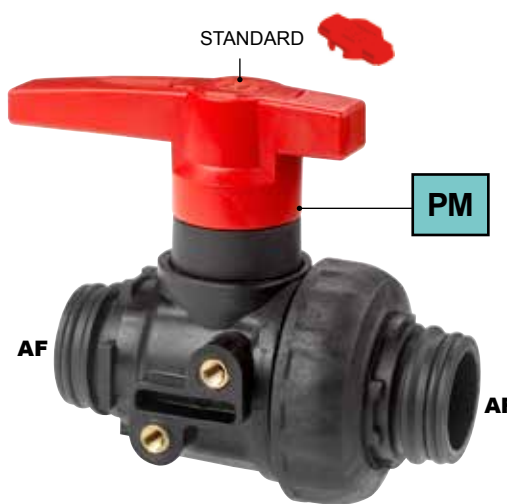

Montaggio a pannello
Panel mounting
Installation au panneau

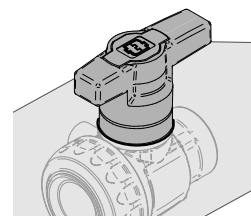

STD		PM			°C	bar	Type	Pack
Part No.	Part No.	AF	Lever					
8215601	8217601	3	LL	60 ⇌ 16	-	10		
8215701	8217701	5	LL	60 ⇌ 10	1	10		
8215751	8217751	6	LL	60 ⇌ 10	2	10		
8215801	8217801	7	LL	60 ⇌ 8	2	10		
8215704	-	5	LC	60 ⇌ 10	1	10		
8215754	-	6	LC	60 ⇌ 10	2	10		
8215804	-	7	LC	60 ⇌ 8	2	10		

PM = Panel Mounting **LL**= Long Lever **LC**= Short Lever

Flusso ON-OFF
ON-OFF flow
Passage ON-OFF

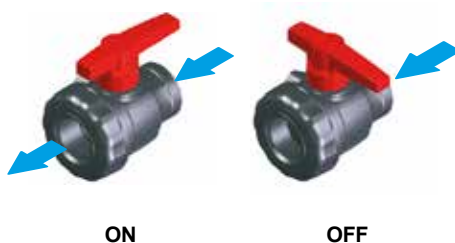

Valvola a sfera a 3 vie - ON-OFF e FLUSSO CONTINUO

- Evita l'innalzamento brusco della pressione durante la deviazione da una via all'altra;
- Struttura in polipropilene rinforzato con fibra di vetro per una maggiore robustezza e resistenza chimica;
- Sedi in Teflon garantiscono una facile maneggevolezza ed una buona tenuta;
- Guarnizioni in EPDM per trattamenti con fertilizzanti e agenti chimici. Viton® disponibile su richiesta;
- Pressione di lavoro per dimensioni fino a 1"1/4 PN 16, per dimensioni superiori PN 10;
- Disponibile anche in versione per montaggio a pannello (PM).

3-ways ball valve - ON-OFF and CONTINUOUS FLOW

- To prevent overpressure when, selecting directional flow, the valve cannot be turned off.
- Fiberglass reinforced polypropylene body for strength and chemical resistance.
- Teflon seats for smooth operation and proper sealing.
- EPDM o-rings to handle most fertilizers and chemicals. Viton® on demand.
- Max operating pressure for sizes up to 1"1/4 PN 16 (232 PSI). For bigger sizes PN10 (145 PSI);
- Available also in panel mounting version (PM).

Vanne à bille 3 voies - ON-OFF et A PASSAGE CONTINUU

- Empêche à la pression de monter tout à coup quand on passe d'une voie à l'autre.
- Corps en polypropylène renforcé par fibres de verre pour garantir robustesse et résistance aux produits chimiques.
- Sièges en Teflon qui garantissent maniabilité et étanchéité optimale.
- Joints en EPDM pour l'usage de la plus part de fertilizants et de produits chimiques. Viton® sur demande.
- Pression de travail pour dimensions jusqu'à 1"1/4 PN 16, pour dimensions supérieures PN 10;
- Disponible aussi en version pour montage sur panneau (PM).

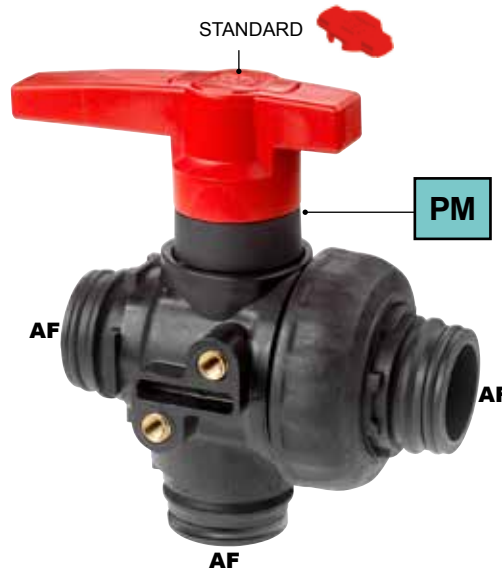
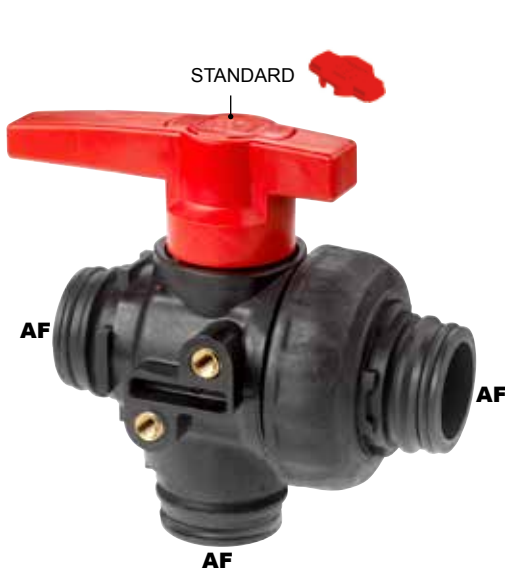

PM Montaggio a pannello
Panel mounting
Installation au panneau

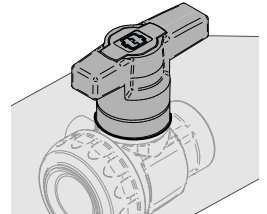

ON-OFF flow

STD	PM					
Part No.	Part No.	AF	Lever	°C	bar	Pack
8216601	8218601	3	FF LL	60	⇒ 16	10
8216701	8218701	5	FF LL	60	⇒ 10	10
8216751	8218751	6	FF LL	60	⇒ 10	10
8216801	8218801	7	FF LL	60	⇒ 8	10
8216704	-	5	FF LC	60	⇒ 10	10
8216754	-	6	FF LC	60	⇒ 10	10
8216804	-	7	FF LC	60	⇒ 8	10

PM = Panel Mounting **FF**= Female/Female
LL= Long Lever **LC**= Short Lever

Continuous flow

STD	PM					
Part No.	Part No.	AF	Lever	°C	bar	Pack
8216703	8218703	5	FF LL	60	⇒ 10	10
8216753	8218753	6	FF LL	60	⇒ 10	10
8216803	8218803	7	FF LL	60	⇒ 8	10
8216706	-	5	FF LC	60	⇒ 10	10
8216756	-	6	FF LC	60	⇒ 10	10
8216806	-	7	FF LC	60	⇒ 8	10

PM = Panel Mounting **FF**= Female/Female
LL= Long Lever **LC**= Short Lever

Flusso ON-OFF
ON-OFF flow
Passage ON-OFF

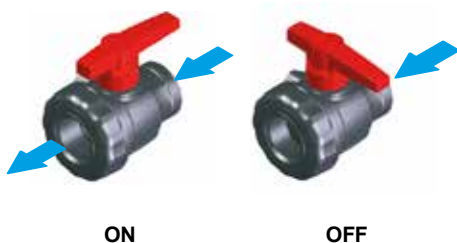

Flusso continuo
Continuous flow
A passage continuu



Valvola a sfera a 3 vie

- Struttura in polipropilene rinforzato con fibra di vetro per una maggiore robustezza e resistenza chimica;
- Sedi in Teflon garantiscono una facile maneggevolezza ed una buona tenuta;
- Guarnizioni in EPDM per trattamenti con fertilizzanti e agenti chimici. Viton® disponibile su richiesta;
- Pressione di lavoro per dimensioni fino a 1"1/4 PN 16, per dimensioni superiori PN 10;
- Disponibile anche in versione per montaggio a pannello (PM).

3-ways ball valve

- Fiberglass reinforced polypropylene body for strength and chemical resistance.
- Teflon seats for smooth operation and proper sealing characteristics.
- EPDM o-rings to handle most fertilizers and chemicals. Viton® on demand.
- Max operating pressure for sizes up to 1"1/4 PN 16 (232 PSI). For bigger sizes PN10 (145 PSI);
- Available also in panel mounting version (PM).

Vanne à bille 3 voies

- Corps en polypropylène renforcé par fibres de verre pour garantir une grande robustesse et une bonne résistance aux produits chimiques.
- Sièges en Teflon qui garantissent une maniabilité et une étanchéité optimale.
- Joints en EPDM pour l'usage de la plus part de fertilizants et de produits chimiques. Viton® sur demande.
- Pression de travail pour dimensions jusqu'à 1"1/4 PN 16, pour dimensions supérieures PN 10.;
- Disponible aussi en version pour montage sur panneau (PM).

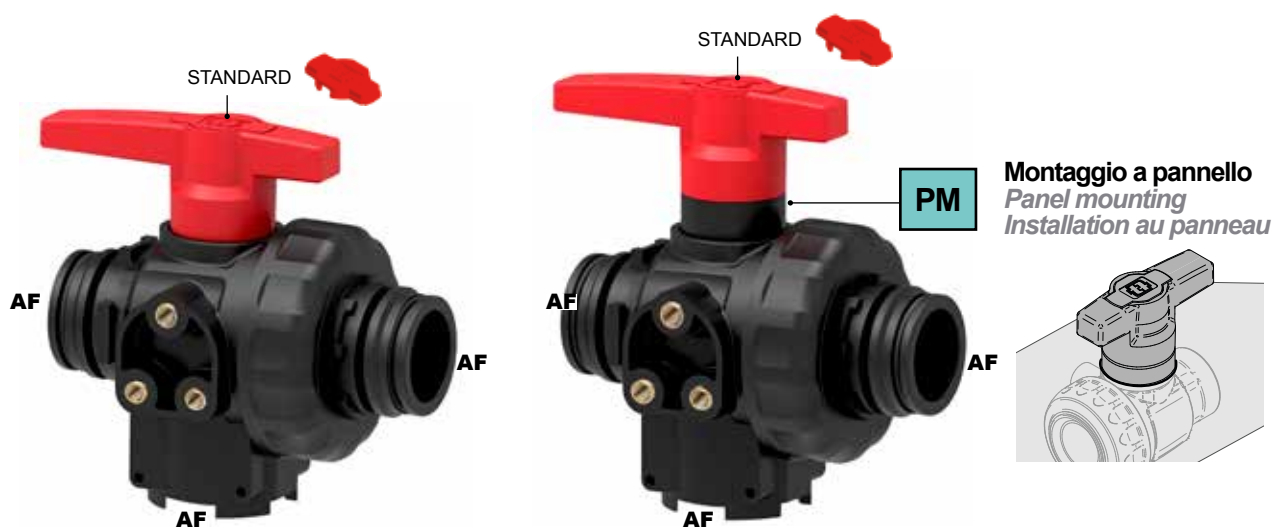

STD		PM					
Part No.	Part No.	AF	Lever	°C	bar	Type	Pack
8216776	8218776	6	MF LL	60 ⇄ 10	2	10	
8216778	8218778	6	MF LL	60 ⇄ 10	2	10	

PM = Panel Mounting MF= Male/Female LL= Long Lever

Flusso ON-OFF
ON-OFF flow
Passage ON-OFF

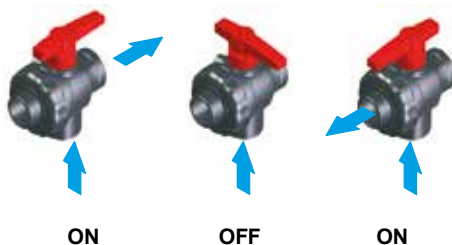

Valvola a sfera 2 vie - NPT

- Struttura in polipropilene rinforzato con fibra di vetro per una maggiore robustezza e resistenza chimica;
 - Sedi in Teflon garantiscono una facile maneggevolezza ed una buona tenuta;
 - Guarnizioni in EPDM per trattamenti con fertilizzanti e agenti chimici.
- Viton® disponibile su richiesta;
- Pressione di lavoro per dimensioni fino a 1"1/4 PN 16, per dimensioni superiori PN 10.

2-ways ball valve - NPT

- Fiberglass reinforced polypropylene body for strength and chemical resistance.
- Teflon seats for smooth operation and proper sealing characteristics.
- EPDM o-rings to handle most fertilizers and chemicals. Viton® on demand.
- Max operating pressure for sizes up to 1"1/4 PN 16 (232 PSI). For bigger sizes PN10 (145 PSI).

Vanne à bille 2 voies - NPT

- Corps en polypropylène renforcé par fibres de verre pour garantir une grande robustesse et une bonne résistance aux produits chimiques.
- Sièges en Teflon qui garantissent une maniabilité et une étanchéité optimale.
- Joints en EPDM pour l'usage de la plus part de fertilizants et de produits chimiques. Viton® sur demande.
- Pression de travail pour dimensions jusqu'à 1"1/4 PN 16, pour dimensions supérieures PN 10.



DIMENSIONS

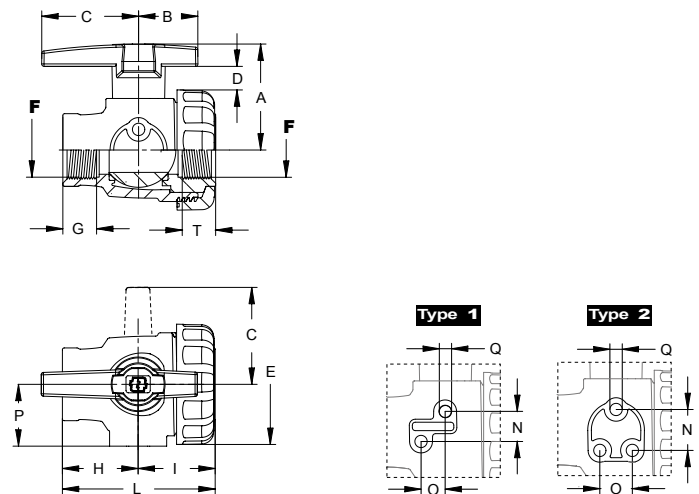

Part No.	F (NPT)	Lever	A	B	C	D	E	G	H	I	L	N	O	P	Q	T	°C	bar	Type	Pack		
8215127	3/8"	FF	LL	60	42	42	16	59	23	43,5	44,5	88	-	-	-	23	60	⇔	16	-	10	
8215228	3/4"	FF	LL	60	42	42	16	59	23	43,5	44,5	88	-	-	-	23	60	⇔	16	-	10	
8215178	1/2"	FF	LL	60	42	42	16	59	23	43,5	44,5	88	-	-	-	23	60	⇔	16	-	10	
8215278	1"	FF	LL	73	42	53	20	69	23	46,5	52	98,5	25	20	37	M8	25	60	⇔	16	1	10
8215328	1"1/4	FF	LL	80	42	77	20	82	25	53,5	55	108,5	25	20	43	M8	26	60	⇔	10	1	10
8215378	1"1/2	FF	LL	87	49	80	20	99	28	62,5	63,5	126	34	27	51	M8	28	60	⇔	10	2	10
8215428	2"	FF	LL	110	49	130	25	115	30	73	75,5	148,5	78	43	51	M8	30	60	⇔	10	2	10

FF = Female/Female LL = Long Lever LC = Short Lever

Flusso ON-OFF
ON-OFF flow
Passage ON-OFF



Valvola a sfera a 3 vie - NPT

- Struttura in polipropilene rinforzato con fibra di vetro per una maggiore robustezza e resistenza chimica;
- Sedi in Teflon garantiscono una facile maneggevolezza ed una buona tenuta;
- Guarnizioni in EPDM per trattamenti con fertilizzanti e agenti chimici. Viton® disponibile su richiesta;
- Pressione di lavoro per dimensioni fino a 1"1/4 PN 16, per dimensioni superiori PN 10.

3-ways ball valve - NPT

- Fiberglass reinforced polypropylene body for strength and chemical resistance.
- Teflon seats for smooth operation and proper sealing characteristics.
- EPDM o-rings to handle most fertilizers and chemicals. Viton® on demand.
- Max operating pressure for sizes up to 1"1/4 PN 16 (232 PSI). For bigger sizes PN10 (145 PSI).

Vanne à bille 3 voies - NPT

- Corps en polypropylène renforcé par fibres de verre pour garantir une grande robustesse et une bonne résistance aux produits chimiques.
- Sièges en Teflon qui garantissent une maniabilité et une étanchéité optimale.
- Joints en EPDM pour l'usage de la plus part de fertilizants et de produits chimiques. Viton® sur demande.
- Pression de travail pour dimensions jusqu'à 1"1/4 PN 16, pour dimensions supérieures PN 10.



DIMENSIONS

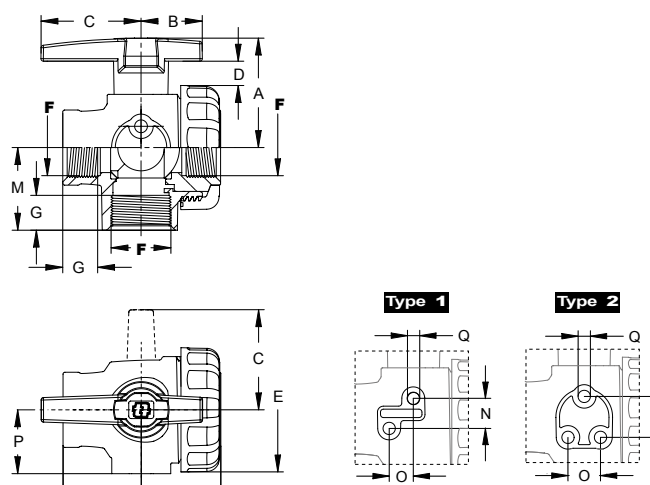

Part No.	F (NPT)	Lever	A	B	C	D	E	G	H	I	L	M	N	O	P	Q	T	°C	bar	Type	Pack		
8216180	1/2"	FF	LL	60	42	42	16	59	23	43,5	44,5	88	42	-	-	-	23	60	⇒	16	-	10	
8216230	3/4"	FF	LL	60	42	42	16	59	23	43,5	44,5	88	42	-	-	-	23	60	⇒	16	-	10	
8216276	1"	FF	LL	73	42	53	20	69	23	46,5	52	98,5	47	25	20	37	M8	25	60	⇒	16	1	10
8216330	1"1/4	FF	LL	80	42	77	20	82	25	53,5	55	108,5	53,5	25	20	43	M8	26	60	⇒	10	1	10
8216380	1"1/2	FF	LL	87	49	80	20	99	28	62,5	63,5	126	66	34	27	51	M8	28	60	⇒	10	2	10
8216428	2"	FF	LL	110	49	130	25	115	30	73	75,5	148,5	81	78	43	51	M8	30	60	⇒	10	2	10

FF = Female/Female LL = Long Lever LC = Short Lever

Flusso ON-OFF
ON-OFF flow
Passage ON-OFF

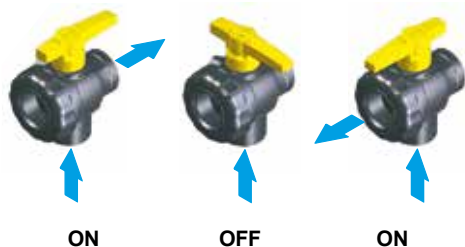

DIMENSIONS

2-ways ball valve - FF

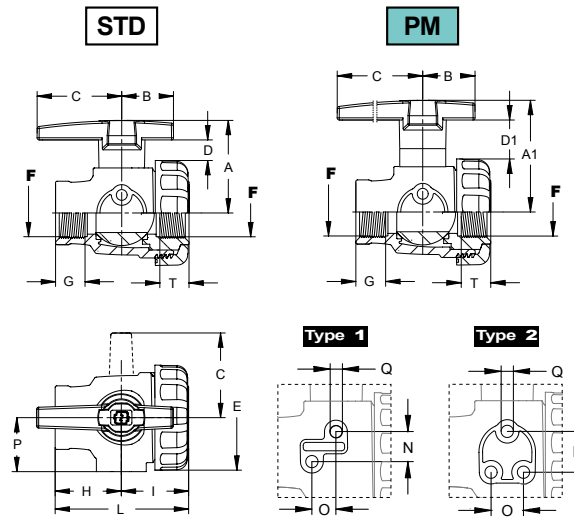

F	Lever	A	A1	B	C	D	D1	E	G	H	I	L	N	O	P	Q	T	Type
		mm	mm	mm	mm	mm	mm	mm	mm	mm	mm	mm	mm	mm	mm	mm	mm	
G 3/8"	FF LL	48	-	19	39	10	-	50	14	35	39	74	-	-	-	-	14	-
G 1/2"	FF LL	60	82	42	42	16	38	59	23	43,5	44,5	88	-	-	-	-	23	-
G 3/4"	FF LL	60	82	42	42	16	38	59	23	43,5	44,5	88	-	-	-	-	23	-
G 1"	FF LL	73	89	42	53	20	36	69	23	46,5	52	98,5	25	20	37	M8	25	1
G 1 1/4"	FF LL	80	96	42	77	20	36	82	25	53,5	55	108,5	25	20	43	M8	26	1
G 1 1/2"	FF LL	87	103	49	80	20	36	99	28	62,5	63,5	126	34	27	51	M8	28	2
G 2"	FF LL	110	136	49	130	25	47	115	30	73	75,5	148,5	78	43	51	M8	30	2
G 1 1/4"	FF LC	80	-	42	50	20	-	82	25	53,5	55	108,5	25	20	37	M8	26	1
G 1 1/2"	FF LC	87	-	49	60	20	-	99	28	62,5	63,5	126	34	27	51	M8	28	2
G 2"	FF LC	110	-	75	75	25	-	115	30	73	75,5	148,5	78	43	51	M8	30	2

DIMENSIONS

2-ways ball valve - MF

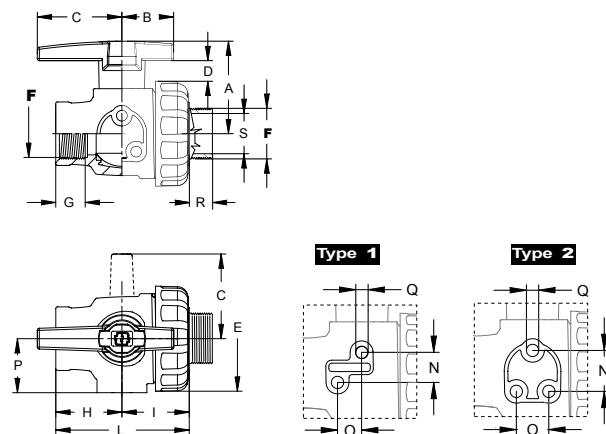

F	Lever	A	B	C	D	E	G	H	I	L	N	O	P	Q	R	S	T	Type
		mm	mm	mm	mm	mm	mm	mm	mm	mm	mm	mm	mm	mm	mm	mm	mm	
G 1"	MF LL	73	42	53	20	69	23	46,5	52	98,5	25	20	37	M8	22	25	25	1
G 1 1/4"	MF LL	80	42	77	20	82	25	53,5	55	108,5	25	20	43	M8	22	32	26	1
G 1 1/2"	MF LL	87	49	80	20	99	28	62,5	63,5	126	34	27	51	M8	22	38	28	2
G 2"	MF LL	110	49	130	25	115	30	73	75,5	148,5	78	43	51	M8	25	48	30	2
G 1 1/4"	MF LC	80	42	50	20	82	25	53,5	55	108,5	25	20	37	M8	22	25	26	1
G 1 1/2"	MF LC	87	49	60	20	99	28	62,5	63,5	126	34	27	51	M8	22	32	28	2
G 2"	MF LC	110	75	75	25	115	30	73	75,5	148,5	78	43	51	M8	22	38	30	2

DIMENSIONS

3-ways ball valve - FF

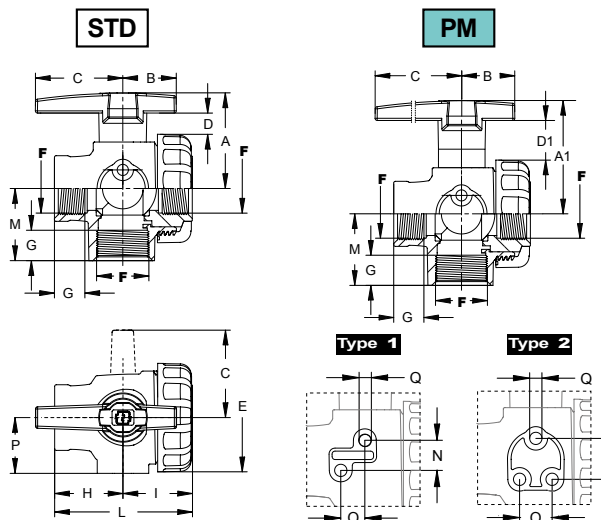

F	Lever	A	A1	B	C	D	D1	E	G	H	I	L	M	N	O	P	Q	T	Type
		mm	mm	mm	mm	mm	mm	mm	mm	mm	mm	mm	mm	mm	mm	mm	mm	mm	
G 1/2"	FF LL	60	82	42	42	16	38	59	23	43,5	44,5	88	42	-	-	-	-	23	-
G 3/4"	FF LL	60	82	42	42	16	38	59	23	43,5	44,5	88	42	-	-	-	-	23	-
G 1"	FF LL	73	89	42	53	20	36	69	23	46,5	52	98,5	47	25	20	37	M8	25	1
G 1 1/4"	FF LL	80	96	42	77	20	36	82	25	53,5	55	108,5	53,5	25	20	43	M8	26	1
G 1 1/2"	FF LL	87	103	49	80	20	36	99	28	62,5	63,5	126	66	34	27	51	M8	28	2
G 2"	FF LL	110	136	49	130	25	51	115	30	73	75,5	148,5	81	78	43	51	M8	30	2
G 1 1/4"	FF LC	80	-	42	50	20	-	82	25	53,5	55	108,5	53,5	25	20	43	M8	26	1
G 1 1/2"	FF LC	87	-	49	60	20	-	99	28	62,5	63,5	126	66	34	27	51	M8	28	2
G 2"	FF LC	110	-	75	75	25	-	115	30	73	75,5	148,5	81	78	43	51	M8	30	2

DIMENSIONS

3-ways ball valve - MF

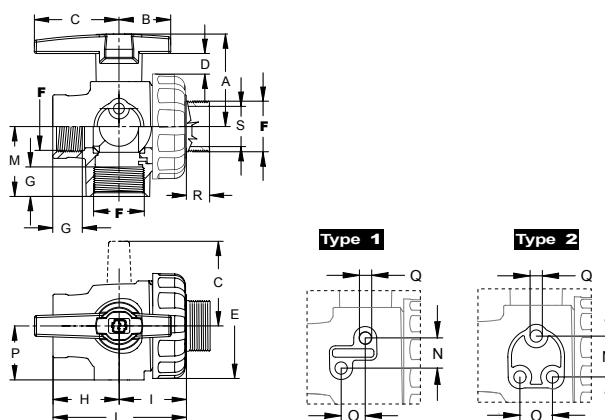

F	Lever	A	B	C	D	E	G	H	I	L	M	N	O	P	Q	R	S	Type
		mm	mm	mm	mm	mm	mm	mm	mm	mm	mm	mm	mm	mm	mm	mm	mm	
G 1"	MF LL	73	42	53	20	69	23	46,5	52	98,5	47	25	20	37	M8	22	25	1
G 1 1/4"	MF LL	80	42	77	20	82	25	53,5	55	108,5	53,5	25	20	43	M8	22	32	1
G 1 1/2"	MF LL	87	49	80	20	99	28	62,5	63,5	126	66	34	27	51	M8	22	38	2
G 2"	MF LL	110	49	130	25	115	30	73	75,5	148,5	81	78	43	51	M8	25	48	2
G 1 1/4"	MF LC	80	42	50	20	82	25	53,5	55	108,5	53,5	25	20	43	M8	22	32	1
G 1 1/2"	MF LC	87	49	60	20	99	28	62,5	63,5	126	66	34	27	51	M8	22	38	2
G 2"	MF LC	110	75	75	25	115	30	73	75,5	148,5	81	78	43	51	M8	25	48	2

DIMENSIONS

2-ways ball valve - FF - AF

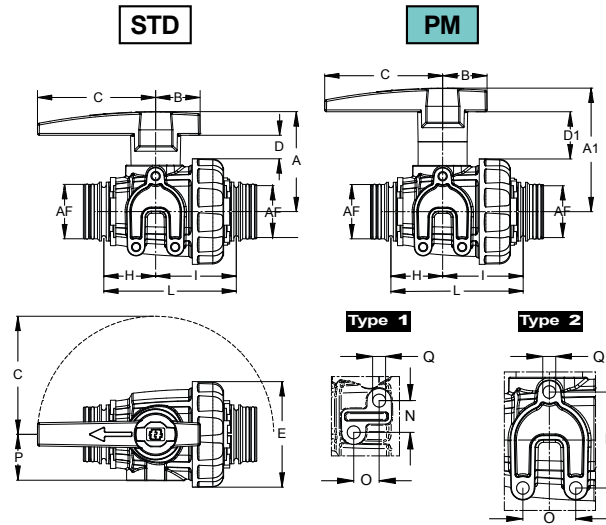

AF	Lever	A mm	A1 mm	B mm	C mm	D mm	D1 mm	E mm	H mm	I mm	L mm	N mm	O mm	P mm	Q	Type
3	FF LL	60	82	42	42	16	38	59	33	52	85	-	-	-	-	-
5	FF LL	80	97	42	80	20	36	82	38	64	102	25	20	43	M8	1
6	FF LL	87	103	49	80	20	36	99	48	76	124	34	27	51	M8	2
7	FF LL	110	136	49	130	25	52	116	57	89	146	78	43	51	M8	2
5	FF LC	80	-	42	53	20	-	82	38	64	102	25	20	43	M8	1
6	FF LC	87	-	49	60	20	-	99	48	76	124	34	27	51	M8	2
7	FF LC	110	-	75	75	25	-	116	57	89	146	78	43	51	M8	2

DIMENSIONS

3-ways ball valve - FF - AF

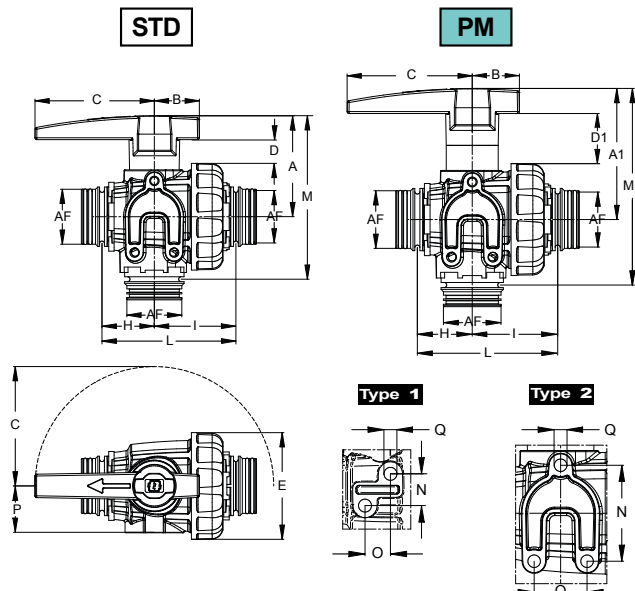

AF	Lever	A mm	A1 mm	B mm	C mm	D mm	D1 mm	E mm	H mm	I mm	L mm	M mm	M1 mm	N mm	O mm	P mm	Q	Type
3	FF LL	60	82	42	42	16	38	59	33	52	88	98	120	-	-	-	-	-
5	FF LL	80	97	42	80	20	36	82	38	64	102	128	145	25	20	43	M8	1
6	FF LL	87	103	49	80	20	36	99	48	76	124	149	165	34	27	51	M8	2
7	FF LL	110	136	49	130	25	52	116	57	89	146	178	204	78	43	51	M8	2
5	FF LC	80	-	42	53	20	-	82	38	64	102	128	-	25	20	43	M8	1
6	FF LC	87	-	49	60	20	-	99	48	76	124	149	-	34	27	51	M8	2
7	FF LC	110	-	75	75	25	-	116	57	89	146	178	-	78	43	51	M8	2

DIMENSIONS

2-ways ball valve - MF - AF

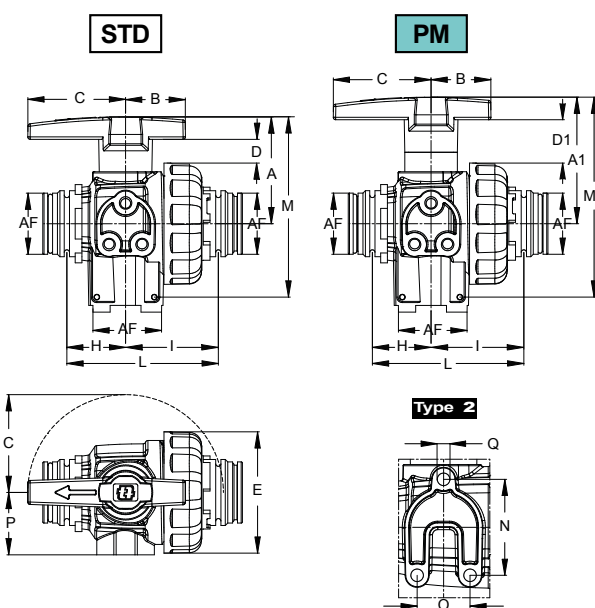

AF	Lever	A mm	A1 mm	B mm	C mm	D mm	D1 mm	E mm	H mm	I mm	L mm	M mm	M1 mm	N mm	O mm	P mm	Q	Type
6	MF LL	87	103	49	80	20	36	99	48	76	124	147	163	34	27	51	M8	2
6	MF LL	87	103	49	80	20	36	99	48	76	124	147	163	34	27	51	M8	2

OPTIONALS

Tappi segnaletici colorati.





Indication coloured plug.

Bouchon signalétiques colorés.





Part No.	Colour	Pack
T00000020		1
T00000021		1
T00000022		1
T00000023		1
Pag. 180-181	AF	25

LEGENDA

Campo di impiego / Use / Utilisation

-  Per macchine a basso volume
For low-volume spraying machines
Pour machines basse volum
-  Per macchine da diserbo
For crop sprayers
Pour pulvérisateurs
-  Per atomizzatori
For orchard sprayers
Pour atomiseurs
-  Componente modulare
Modular component
Composant modulaire

Caratteristiche / Features / Caractéristiques

-  Portata della pompa
Pump flow rate
Débit de la pompe
-  Portata
Flow rate
Débit
-  Pressione d'esercizio
Operating pressure
Pression de service
-  Cartuccia filtrante
Filtering cartridge
Cartouche filtrante

FEATURES

-  Prodotti non per uso alimentare
Products not for food use
Produits non pour un usage alimentaire
-  60°C
MAX
Temperatura massima
Max temperature
Temperature maxi

CONVERSION TABLE



Thread	Fork coupling
3/4"	AF3
1"	AF4
1" 1/4	AF5
1" 1/2	AF6
2"	AF7
3"	AF9

FILTRI DI ASPIRAZIONE E MANDATA

SUCTION AND LINE FILTERS / FILTRES D'ASPIRATION ET FILTRES EN LIGNE

3

Filtri di aspirazione e mandata

I filtri di aspirazione GEOLINE vengono realizzati in polipropilene, con guarnizioni in EPDM (Viton® a richiesta), particolari metallici interni in acciaio inox AISI 304, particolari metallici esterni di fissaggio in ottone, cartucce filtranti in polipropilene con reti in acciaio inox AISI 304 o in polipropilene.

I filtri di mandata GEOLINE vengono realizzati in polipropilene o nylon rinforzato con fibra di vetro, ghiere in polipropilene rinforzato con fibra di vetro, guarnizioni di tenuta in EPDM (Viton® a richiesta), particolari metallici interni in acciaio inox AISI 304, cartucce filtranti in polipropilene con reti in acciaio inox AISI 304.

Suction and line filters

GEOLINE suction filters are in polypropylene, with EPDM gaskets (Viton® on demand), internal mechanical details in AISI 304 stainless steel, external fastening brass details, polypropylene filtering cartridge with AISI 304 stainless steel or polypropylene mesh.

GEOLINE line filters are in polypropylene or fiberglass reinforced nylon, with polypropylene back nuts, EPDM seals (Viton® on demand), internal mechanical components in AISI 304 stainless steel, polypropylene filtering cartridge with AISI 304 stainless steel mesh.

Filtres d'aspiration et filtres en ligne

Les filtres d'aspiration GEOLINE sont en polypropylène, avec joints en EPDM (Viton® sur demande), parties intérieures mécaniques en acier inoxydable AISI 304, dispositifs de fixation extérieurs en laiton, cartouches filtrantes en polypropylène avec mailles en acier inoxydable AISI 304 ou en polypropylène.

Les filtres en ligne GEOLINE sont en polypropylène ou en nylon renforcé par des fibres de verre, avec des embouts en polypropylène, des joints d'étanchéité en EPDM (Viton® sur demande), des parties intérieures en acier inoxydable AISI 304 et des cartouches filtrantes en polypropylène avec mailles en acier inoxydable AISI 304.



Filtri di aspirazione per portate fino a 800 l/min.

Suction filters for flow rates up to 800 l/min (211,34 USGpm). *Filtres d'aspiration pour débits jusqu'à 800 l/min.*



COLOR CODING



Part No.	F	l/1'	Mesh	Screen Material	Effective Area cm ²	Sq.in.	Pack
8101000	G 3 M		32	inox	505	78,3	1
8101001	G 3 M	400/800	50	inox	464	71,9	1
8101002	G 3 M		80	inox	809	78,8	1

SPARE PARTS

Part No.	Screen Mesh	Screen Material
C00100077	32	INOX
C00100078	50	
C00100079	80	

Part No.	Gasket	Material
G00001261	O-Ring	EPDM

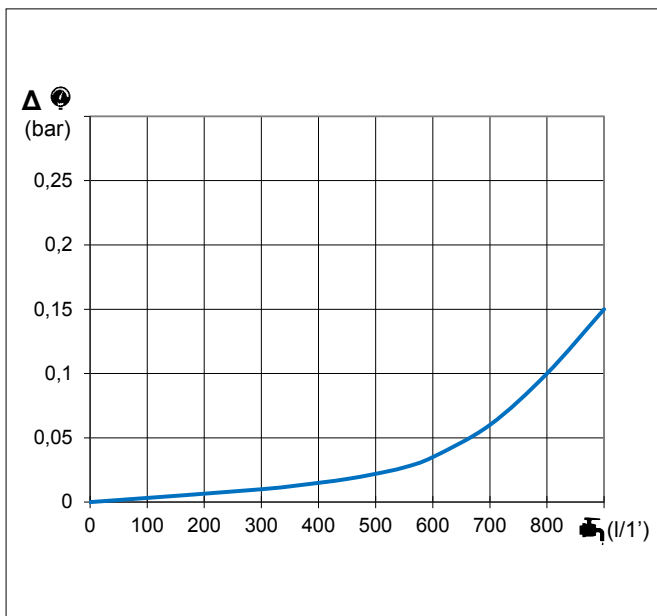

DIMENSIONS

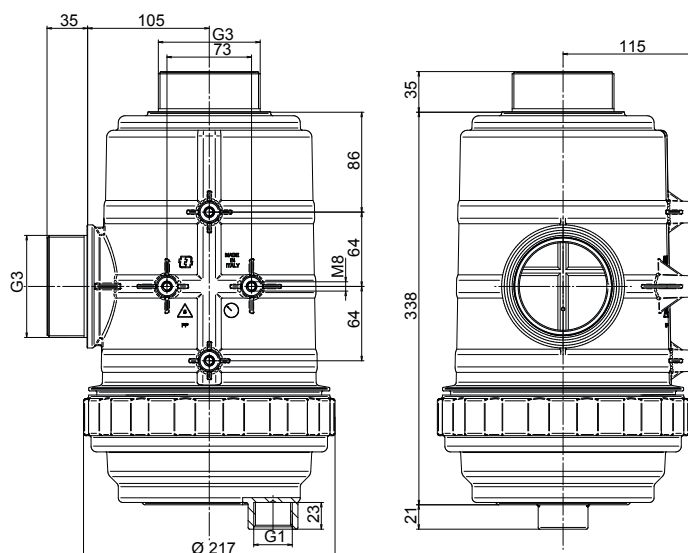

Filtri di aspirazione per portate fino a 800 l/min.

Suction filters for flow rates up to 800 l/min
 (211,34 USGpm).

Filtres d'aspiration pour débits jusqu'à 800 l/min.



Part No.	F	l/1'	Mesh	Screen Material	Effective Area cm ²	Sq.in.	Pack
8101003	AF9		32	inox	505	78,3	1
8101004	AF9	400/800	50	inox	464	71,9	1
8101005	AF9		80	inox	809	78,8	1

SPARE PARTS

Part No.	Screen Mesh	Screen Material
C00100077	32	INOX
C00100078	50	
C00100079	80	

Part No.	Gasket	Material
G00001261	O-Ring	EPDM

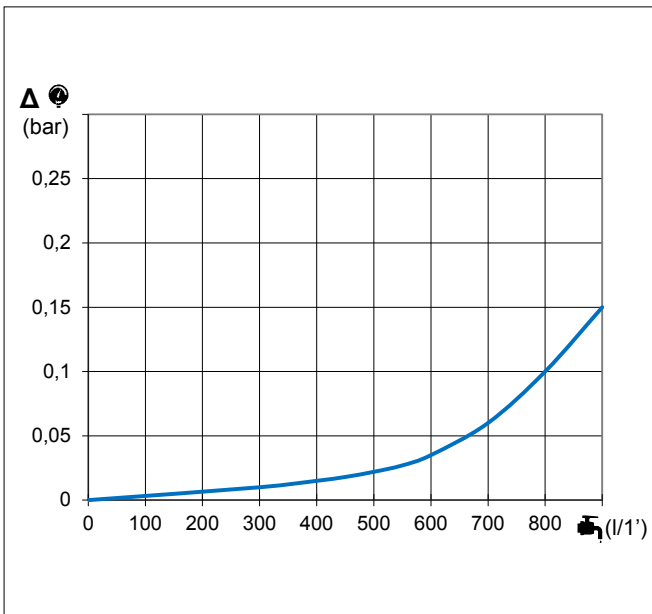

DIMENSIONS

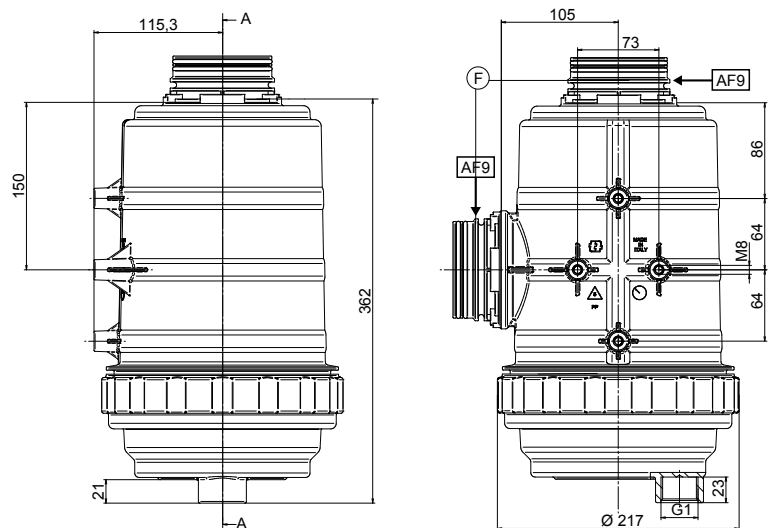

Filtri di aspirazione con valvola per portate fino a 260 l/min

Suction filters with valve for flow rates up to 260 l/min (69 USGpm)

Filtres d'aspiration avec vanne pour debits jusqu'à 260 l/min.

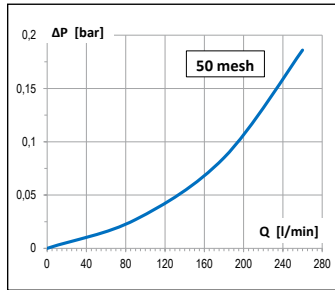

Part No.	F	H	I/1'	Mesh	Screen Material	Effective Area	Pack
		mm				cm ² Sq.in.	
8096000				32		342 53	
8096001	G 2 M	27	260	50	INOX	314 49	10
8096002				80		286 44	
8096003				32		342 53	
8096004	G 2 M	44	260	50	INOX	314 49	10
8096005				80		286 44	

SPARE PARTS

Part No.	Screen Mesh	Screen Material
C00100055	16	INOX
C00100046	32	
C00100047	50	
C00100048	80	

Part No.	Gasket Material
G00001042	O-Ring EPDM

DIMENSIONS

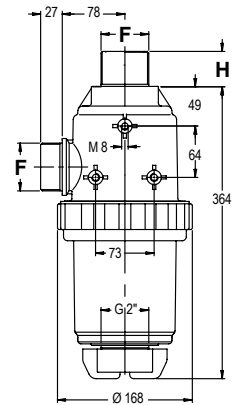

Filtri di aspirazione con valvola per portate fino a 260 l/min

Suction filters with valve for flow rates up to 260 l/min (69 USGpm)

Filtres d'aspiration avec vanne pour debits jusqu'à 260 l/min.

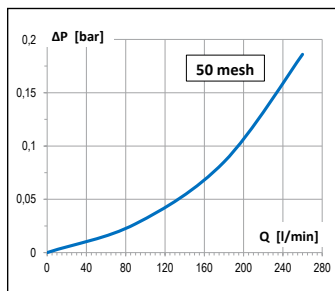

Part No.	F	I/1'	Mesh	Screen Material	Effective Area	Pack
					cm ² Sq.in.	
8096010			16		370 58	
8096011	AF7	260	32	INOX	342 53	10
8096012			50		314 49	
8096013			80		286 44	

SPARE PARTS

Part No.	Screen Mesh	Screen Material
C00100055	16	INOX
C00100046	32	
C00100047	50	
C00100048	80	

Part No.	Gasket Material
G00001042	O-Ring EPDM

DIMENSIONS

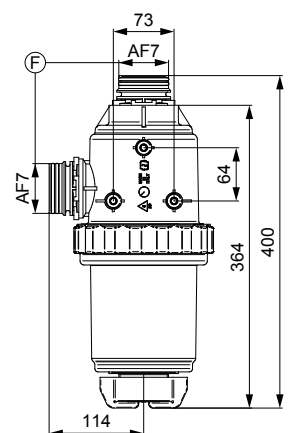

Filtri di aspirazione per portate fino a 260 l/min.

Suction filters for flow rates up to 260 l/min (69 USGpm).

Filtres d'aspiration pour débits jusqu'à 260 l/min.



COLOR CODING

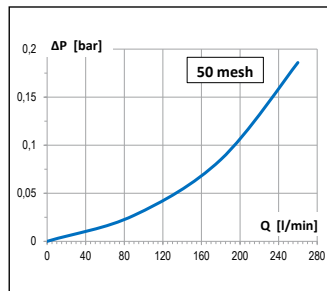

Part No.	F	H	I/1'	Mesh	Screen Material	Effective Area	cm ²	Sq.in.	Pack
8095000				32		342	53		
8095001	G 2 M	27	260	50	INOX	314	49		10
8095002				80		286	44		
8095003				32		342	53		
8095004	G 2 M	44	260	50	INOX	314	49		10
8095005				80		286	44		

SPARE PARTS

Part No.	Screen Mesh	Screen Material
C00100055	16	INOX
C00100046	32	
C00100047	50	
C00100048	80	

Part No.	Gasket Material
G00001042	O-Ring EPDM

DIMENSIONS

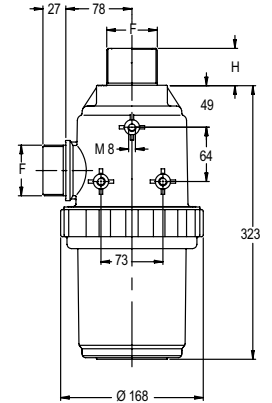

Filtri di aspirazione per portate fino a 260 l/min.

Suction filters for flow rates up to 260 l/min (69 USGpm).

Filtres d'aspiration pour débits jusqu'à 260 l/min.



COLOR CODING

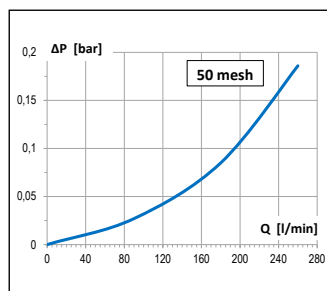

Part No.	F	I/1'	Mesh	Screen Material	Effective Area	cm ²	Sq.in.	Pack
8095011			16		370	58		
8095012	AF7	260	32	INOX	342	53		10
8095013			50		314	49		
8095014			80		286	44		

SPARE PARTS

Part No.	Screen Mesh	Screen Material
C00100055	16	INOX
C00100046	32	
C00100047	50	
C00100048	80	

Part No.	Gasket Material
G00001042	O-Ring EPDM

DIMENSIONS

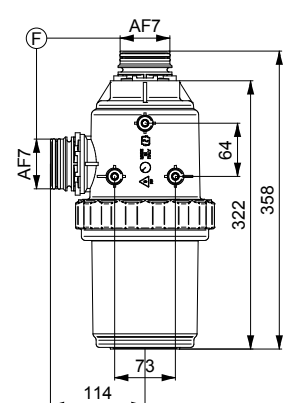

Filtri di aspirazione con valvola per portate fino a 220 l/min.

Suction filters with valve for flow rates up to 220 l/min (58 USGpm).

Filtres d'aspiration avec vanne pour débits jusqu'à 220 l/min.

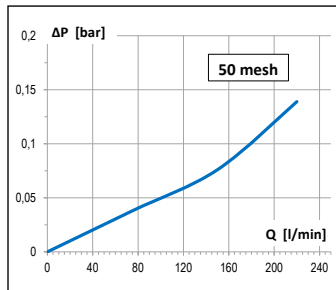

Part No.	F	H mm	I/1'	Mesh	Screen Material	Effective Area cm ²	Sq.in.	Pack
8092007				16		312	48,4	
8092000	G 2 M	27	220	32	INOX	242	37,5	10
8092001				50		222	34,5	
8092002				80		203	31,4	
8092008				16		312	48,4	
8092003	G 2 M	44	220	32	INOX	242	37,5	10
8092004				50		222	34,5	
8092005				80		203	31,4	

SPARE PARTS

Part No.	Screen Mesh	Screen Material
C00100056	16	INOX
C00100008	32	
C00100009	50	
C00100010	80	

Part No.	Gasket Material
G00001042	O-Ring EPDM

DIMENSIONS

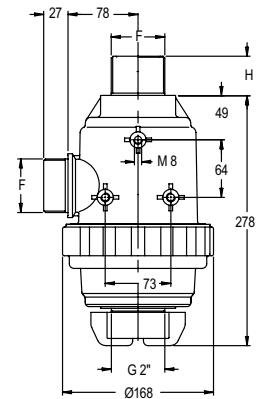

Filtri di aspirazione con valvola per portate fino a 220 l/min.

Suction filters with valve for flow rates up to 220 l/min (58 USGpm).

Filtres d'aspiration avec vanne pour débits jusqu'à 220 l/min.

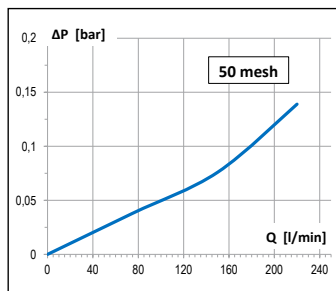

Part No.	F	I/1'	Mesh	Screen Material	Effective Area cm ²	Sq.in.	Pack
8092015			16		312	48,4	
8092016	AF7	220	32	INOX	242	37,5	10
8092017			50		222	34,5	
8092018			80		203	31,4	

SPARE PARTS

Part No.	Screen Mesh	Screen Material
C00100056	16	INOX
C00100008	32	
C00100009	50	
C00100010	80	

Part No.	Gasket Material
G00001042	O-Ring EPDM

DIMENSIONS

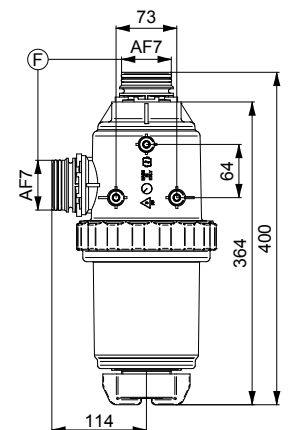

Filtri di aspirazione per portate fino a 220 l/min.

Suction filters for flow rates up to 220 l/min (58 USGpm).

Filtres d'aspiration pour débits jusqu'à 220 l/min.

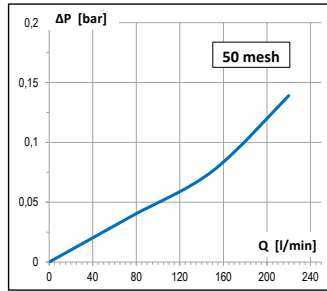

Part No.	F	H mm	I/1'	Mesh	Screen Material	Effective Area cm ²	Sq.in.	Pack
8091000				32		242	37,5	
8091001	G 2 M	27	220	50	INOX	222	34,5	10
8091002				80		203	31,4	
8091007				16		312	48,4	
8091003	G 2 M	44	220	32	INOX	242	37,5	10
8091004				50		222	34,5	
8091005				80		203	31,4	

SPARE PARTS

Part No.	Screen Mesh	Screen Material
C00100056	16	INOX
C00100008	32	
C00100009	50	
C00100010	80	

Part No.	Gasket Material
G00001042	O-Ring EPDM

DIMENSIONS

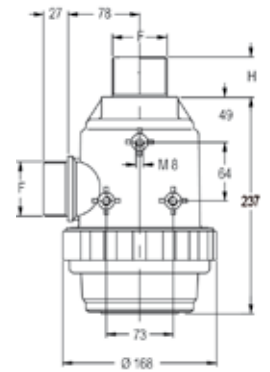

Filtri di aspirazione per portate fino a 220 l/min.

Suction filters for flow rates up to 220 l/min (58 USGpm).

Filtres d'aspiration pour débits jusqu'à 220 l/min.

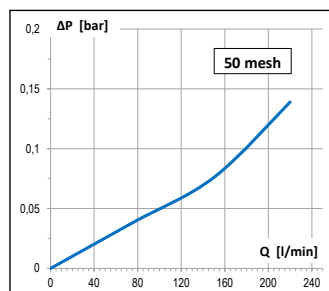
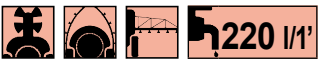

Part No.	F	I/1'	Mesh	Screen Material	Effective Area cm ²	Sq.in.	Pack
8091013			16		312	48,4	
8091014	AF7	220	32	INOX	242	37,5	10
8091015			50		222	34,5	
8091016			80		203	31,4	

SPARE PARTS

Part No.	Screen Mesh	Screen Material
C00100056	16	INOX
C00100008	32	
C00100009	50	
C00100010	80	

Part No.	Gasket Material
G00001042	O-Ring EPDM

DIMENSIONS

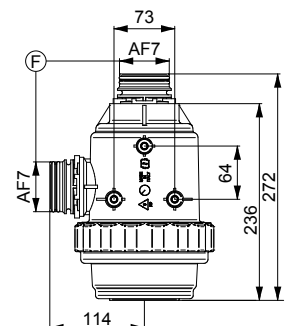

Filtri di aspirazione con valvola per portate fino a 180 l/min.

Suction filters with valve for flow rates up to 180 l/min (47 USGpm).

Filtres d'aspiration avec vanne pour débits jusqu'à 180 l/min.

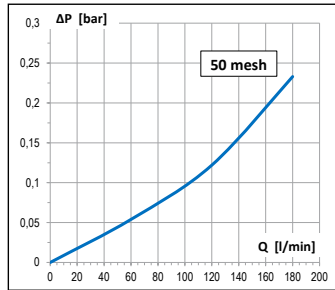
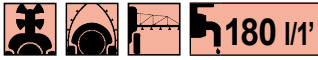

Part No.	F	H	Mesh	Screen Material	Effective Area	Pack
		mm	l/1'		cm ² Sq.in.	
8088000			32		242 37,5	
8088001	G 1½ M	24	180	50	INOX 222 34,5	15
8088002			80		203 31,4	
8088003			32		242 37,5	
8088004	G 1½ M	44	180	50	INOX 222 34,5	15
8088005			80		203 31,4	

SPARE PARTS

Part No.	Screen Mesh	Screen Material
C00100056	16	INOX
C00100008	32	
C00100009	50	
C00100010	80	

Part No.	Gasket Material
G00001042	O-Ring EPDM

DIMENSIONS

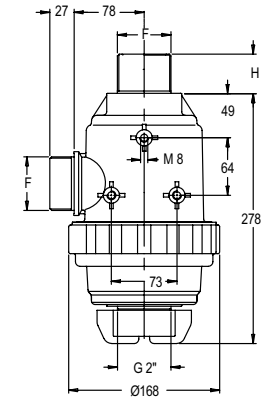

Filtri di aspirazione con valvola per portate fino a 180 l/min.

Suction filters with valve for flow rates up to 180 l/min (47 USGpm).

Filtres d'aspiration avec vanne pour débits jusqu'à 180 l/min.

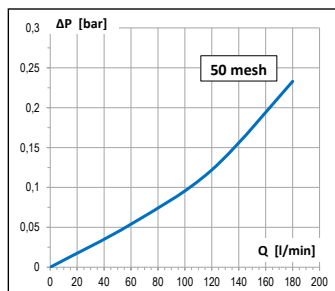
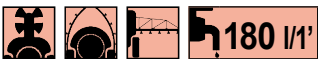

Part No.	F	Mesh	Screen Material	Effective Area	Pack
				cm ² Sq.in.	
8088007		16		261 40,5	
8088008	AF6	180	32	INOX 242 37,5	15
8088009		50		222 34,5	
8088010		80		203 31,4	

SPARE PARTS

Part No.	Screen Mesh	Screen Material
C00100056	16	INOX
C00100008	32	
C00100009	50	
C00100010	80	

Part No.	Gasket Material
G00001042	O-Ring EPDM

DIMENSIONS

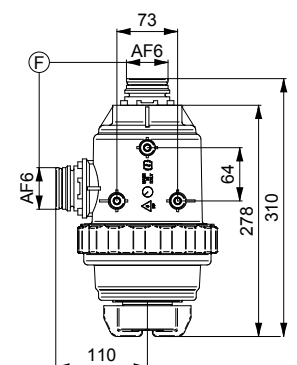

Filtri di aspirazione per portate fino a 180 l/min.

Suction filters for flow rates up to 180 l/min (47 USGpm).

Filtres d'aspiration pour débits jusqu'à 180 l/min.

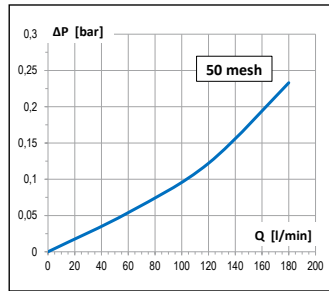

Part No.	F	H	Mesh	Screen Material	Effective Area	Pack
		mm / I/1'			cm ² / Sq.in.	
8087000			32		242 / 37,5	
8087001	G 1½ M	24 / 180	50	INOX	222 / 34,5	15
8087002			80		203 / 31,4	
8087003			32		242 / 37,5	
8087004	G 1½ M	44 / 180	50	INOX	222 / 34,5	15
8087005			80		203 / 31,4	

SPARE PARTS

Part No.	Screen Mesh	Screen Material
C00100056	16	INOX
C00100008	32	
C00100009	50	
C00100010	80	

Part No.	Gasket Material
G00001042	O-Ring EPDM

DIMENSIONS

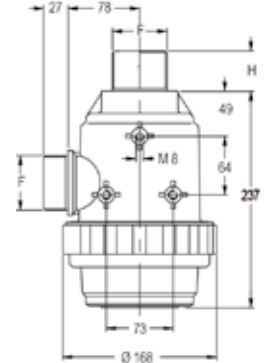

Filtri di aspirazione per portate fino a 180 l/min.

Suction filters for flow rates up to 180 l/min (47 USGpm).

Filtres d'aspiration pour débits jusqu'à 180 l/min.

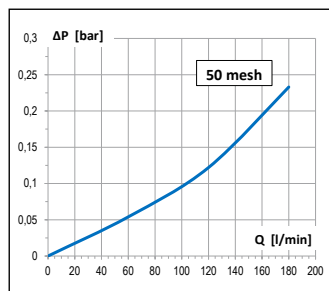
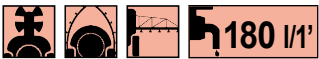

Part No.	F	Mesh	Screen Material	Effective Area	Pack
				cm ² / Sq.in.	
8087009		16		261 / 40,5	
8087010	AF6	32	INOX	242 / 37,5	15
8087011		50		222 / 34,5	
8087012		80		203 / 31,4	

SPARE PARTS

Part No.	Screen Mesh	Screen Material
C00100056	16	INOX
C00100008	32	
C00100009	50	
C00100010	80	

Part No.	Gasket Material
G00001042	O-Ring EPDM

DIMENSIONS

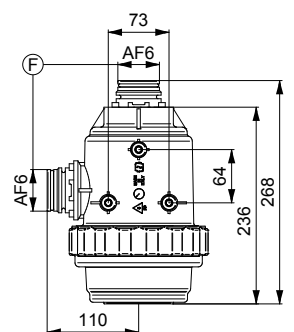

Filtri di aspirazione con valvola per portate fino a 150 l/min.

Suction filters with valve for flow rates up to 150 l/min (40 USGpm).

Filtres d'aspiration avec vanne pour débits jusqu'à 150 l/min.

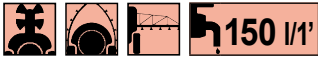

COLOR CODING

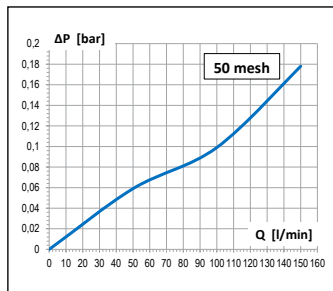

Part No.	F	H	I/1'	Mesh	Screen Material	Effective Area	Pack
		mm				cm ² Sq.in.	
8082010				16		177,8 27,6	
8082000	G 1½ M	24	150	32	INOX	138 21,4	
8082001				50		126 19,5	20
8082002				80		115 17,8	
8082006				16		177,8 27,6	
8082003				32		138 21,4	
8082004	G 1½ M	40	150	50	INOX	126 19,5	20
8082005				80		115 17,8	
8082015				100		110 17,1	

SPARE PARTS

Part No.	Screen Mesh	Screen Material
C00100069	16	
C00100011	32	
C00100012	50	INOX
C00100013	80	
C00100076	100	

Part No.	Gasket Material
G00001040	O-Ring EPDM

DIMENSIONS

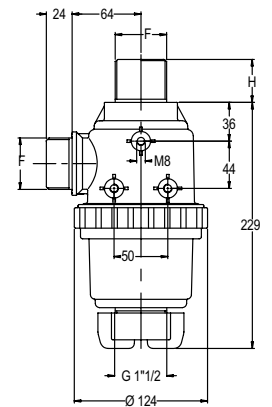

Filtri di aspirazione con valvola per portate fino a 150 l/min.

Suction filters with valve for flow rates up to 150 l/min (40 USGpm).

Filtres d'aspiration avec vanne pour débits jusqu'à 150 l/min.



COLOR CODING

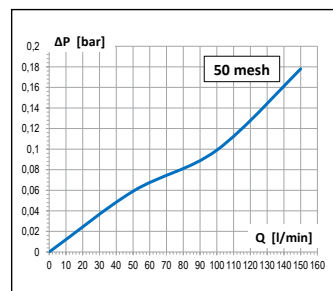

Part No.	F	I/1'	Mesh	Screen Material	Effective Area	Pack
					cm ² Sq.in.	
8082016			16		177,8 27,6	
8082017			32		138 21,4	
8082018	AF6	150	50	INOX	126 19,5	20
8082019			80		115 17,8	
8082020			100		110 17,1	

SPARE PARTS

Part No.	Screen Mesh	Screen Material
C00100069	16	
C00100011	32	
C00100012	50	INOX
C00100013	80	
C00100076	100	

Part No.	Gasket Material
G00001040	O-Ring EPDM

DIMENSIONS

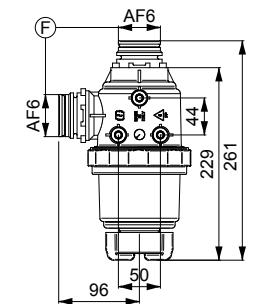

Filtri di aspirazione per portate fino a 150 l/min.

Suction filters for flow rates up to 150 l/min (40 USGpm).

Filtres d'aspiration pour débits jusqu'à 150 l/min.

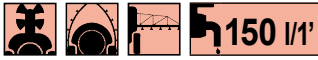

COLOR CODING

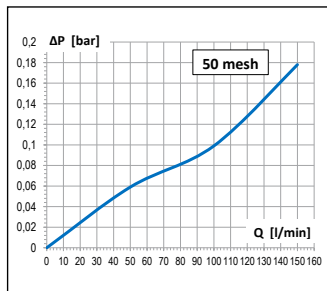

Part No.	F	H	I/1'	Mesh	Screen Material	Effective Area	Pack
		mm				cm ² Sq.in.	
8081000				32		138 21,4	
8081001	G 1½ M	27	150	50	INOX	126 19,5	20
8081002				80		115 17,8	
8081003				32		138 21,4	
8081004	G 1½ M	40	150	50	INOX	126 19,5	20
8081005				80		115 17,8	

SPARE PARTS

Part No.	Screen Mesh	Screen Material
C00100069	16	INOX
C00100011	32	
C00100012	50	
C00100013	80	

Part No.	Gasket Material
G00001040	O-Ring EPDM

DIMENSIONS

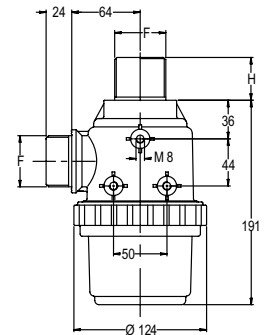

Filtri di aspirazione per portate fino a 150 l/min.

Suction filters for flow rates up to 150 l/min (40 USGpm).

Filtres d'aspiration pour débits jusqu'à 150 l/min.

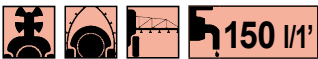

COLOR CODING

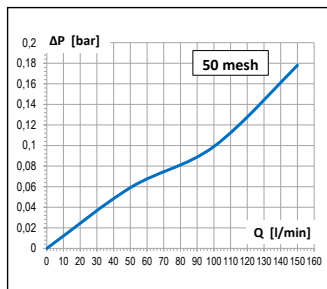

Part No.	F	I/1'	Mesh	Screen Material	Effective Area	Pack
					cm ² Sq.in.	
8081012			16		177,8 27,6	
8081013			32		138 21,4	
8081014	AF6	150	50	INOX	126 19,5	20
8081015			80		115 17,8	
8081016			100		110 17,1	

SPARE PARTS

Part No.	Screen Mesh	Screen Material
C00100069	16	INOX
C00100011	32	
C00100012	50	
C00100013	80	
C00100076	100	

Part No.	Gasket Material
G00001040	O-Ring EPDM

DIMENSIONS

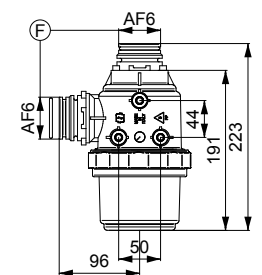

Filtri di aspirazione con valvola per portate fino a 150 l/min.

Suction filters with valve for flow rates up to 150 l/min (40 USGpm).

Filtres d'aspiration avec vanne pour débits jusqu'à 150 l/min.

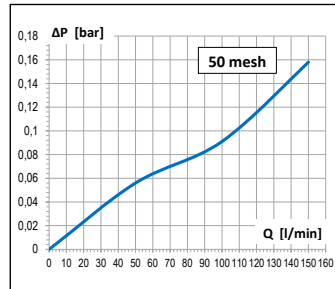

Part No.	F	H mm	I/1'	Mesh	Screen Material	Effective Area cm ²	Sq.in.	Pack
8080000				32		86	13,3	
8080001	G 1½ M	24	150	50	INOX	79	12,3	20
8080002				80		72	11,2	
8080003				32		86	13,3	
8080004	G 1½ M	40	150	50	INOX	79	12,3	20
8080005				80		72	11,2	

SPARE PARTS

Part No.	Screen Mesh	Screen Material
C00100017	32	
C00100018	50	INOX
C00100019	80	

Part No.	Gasket Material
G00001040	O-Ring EPDM

DIMENSIONS

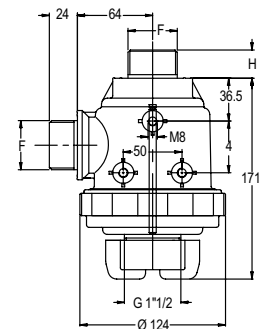

Filtri di aspirazione con valvola per portate fino a 120 l/min.

Suction filters with valve for flow rates up to 120 l/min (32 USGpm).

Filtres d'aspiration avec vanne pour débits jusqu'à 120 l/min.

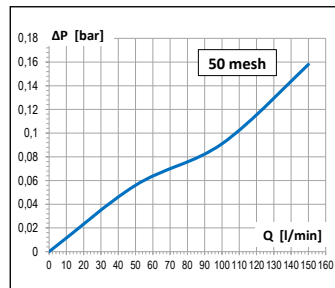

Part No.	F	I/1'	Mesh	Screen Material	Effective Area cm ²	Sq.in.	Pack
8080007			32		86	13,3	
8080008	AF6	120	50	INOX	79	12,3	20
8080009			80		72	11,2	
8080010			100		76	12	

SPARE PARTS

Part No.	Screen Mesh	Screen Material
C00100017	32	
C00100018	50	INOX
C00100019	80	
C00100050	100	

Part No.	Gasket Material
G00001040	O-Ring EPDM

DIMENSIONS

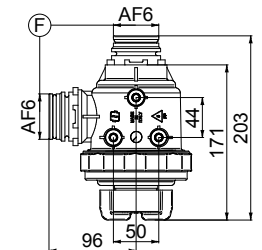

Filtri di aspirazione per portate fino a 150 l/min.

Suction filters for flow rates up to 150 l/min (40 USGpm).

Filtres d'aspiration pour débits jusqu'à 150 l/min.

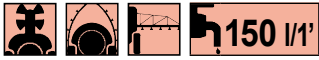

COLOR CODING

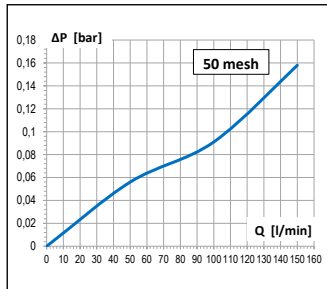

Part No.	F	H mm	l/1'	Mesh	Screen Material	Effective Area cm ²	Sq.in.	Pack
8079000				32		86	13,3	
8079001	G 1½ M	24	150	50	INOX	79	12,3	20
8079002				80		72	11,2	
8079003				32		86	13,3	
8079004	G 1½ M	40	150	50	INOX	79	12,3	20
8079005				80		72	11,2	

SPARE PARTS

Part No.	Screen Mesh	Screen Material
C00100017	32	INOX
C00100018	50	
C00100019	80	

Part No.	Gasket Material
G00001040	O-Ring EPDM

DIMENSIONS

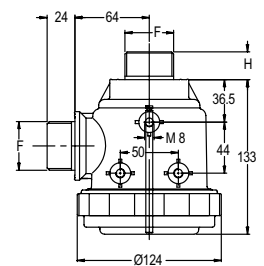

Filtri di aspirazione per portate fino a 120 l/min.

Suction filters for flow rates up to 120 l/min (32 USGpm).

Filtres d'aspiration pour débits jusqu'à 120 l/min.



COLOR CODING

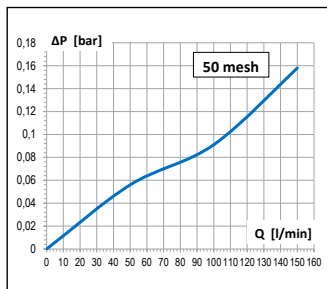

Part No.	F	l/1'	Mesh	Screen Material	Effective Area cm ²	Sq.in.	Pack
8079006			32		86	13,3	
8079007	AF6	120	50	INOX	79	12,3	20
8079008			80				
8079009			100				

SPARE PARTS

Part No.	Screen Mesh	Screen Material
C00100017	32	INOX
C00100018	50	
C00100019	80	
C00100050	100	

Part No.	Gasket Material
G00001040	O-Ring EPDM

DIMENSIONS

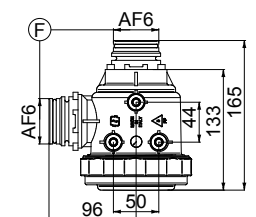

Filtri di aspirazione con valvola per portate fino a 120 l/min.

Suction filters with valve for flow rates up to 120 l/min (32 USGpm).

Filtres d'aspiration avec vanne pour débits jusqu'à 120 l/min.

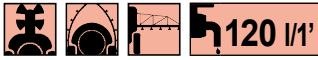

COLOR CODING

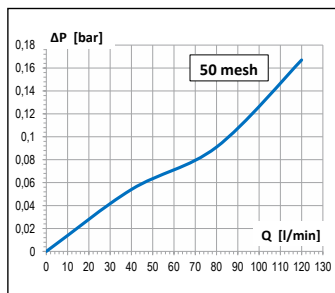

Part No.	F	H	I/1'	Mesh	Screen Material	Effective Area		Pack
						cm ²	Sq.in.	
8078000				32		86	13,3	
8078001	G 1¼ M	24	120	50	INOX	79	12,3	20
8078002				80		72	11,2	
8078006				100		76	12	
8078003				32		86	13,3	
8078004	G 1¼ M	40	120	50	INOX	79	12,3	20
8078005				80		72	11,2	
8078007				100		76	12	

SPARE PARTS

Part No.	Screen Mesh	Screen Material
C00100018	50	
C00100019	80	
C00100050	100	

Part No.	Gasket Material
G00001040	O-Ring EPDM

DIMENSIONS

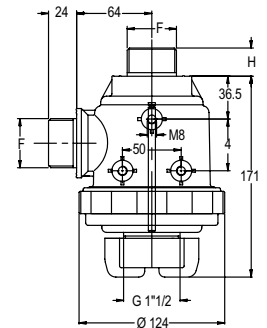

Filtri di aspirazione per portate fino a 120 l/min.

Suction filters for flow rates up to 120 l/min (32 USGpm).

Filtres d'aspiration pour débits jusqu'à 120 l/min.

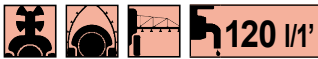

COLOR CODING

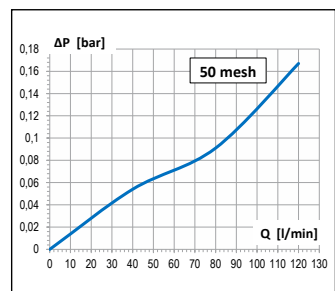

Part No.	F	H	I/1'	Mesh	Screen Material	Effective Area		Pack
						cm ²	Sq.in.	
8077000				32		86	13,3	
8077001	G 1¼ M	24	120	50	INOX	79	12,3	20
8077002				80		72	11,2	
8077006				100		76	12	
8077003				32		86	13,3	
8077004	G 1¼ M	40	120	50	INOX	79	12,3	20
8077005				80		72	11,2	
8077007				100		76	12	

SPARE PARTS

Part No.	Screen Mesh	Screen Material
C00100018	50	
C00100019	80	
C00100050	100	

Part No.	Gasket Material
G00001040	O-Ring EPDM

DIMENSIONS

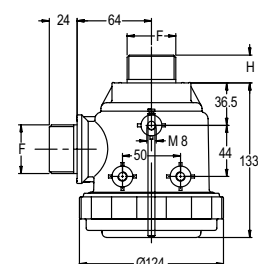

Filtri di aspirazione con valvola per portate fino a 120 l/min.

Suction filters with valve for flow rates up to 120 l/min (40 USGpm).

Filtres d'aspiration avec vanne pour débits jusqu'à 120 l/min.



COLOR CODING

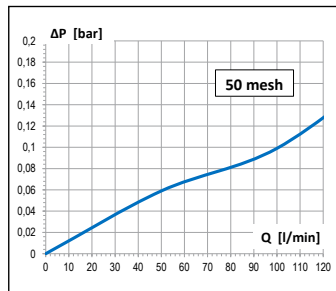

Part No.	F	H	I/1'	Mesh	Screen Material	Effective Area	Pack
		mm				cm ² Sq.in.	
8076007				16		177,8 27,6	
8076000	G 1¼ M	24	120	32	INOX	138 21,4	20
8076001				50		126 19,5	
8076002				80		115 17,8	
8076006				16		177,8 27,6	
8076003	G 1¼ M	40	120	32	INOX	138 21,4	20
8076004				50		126 19,5	
8076005				80		115 17,8	

SPARE PARTS

Part No.	Screen Mesh	Screen Material
C00100069	16	
C00100011	32	INOX
C00100012	50	
C00100013	80	

Part No.	Gasket Material
G00001040	O-Ring EPDM

DIMENSIONS

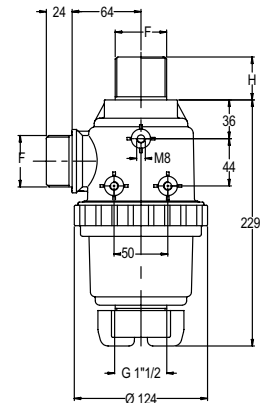

Filtri di aspirazione per portate fino a 120 l/min.

Suction filters for flow rates up to 120 l/min (32 USGpm).

Filtres d'aspiration pour débits jusqu'à 120 l/min.



COLOR CODING

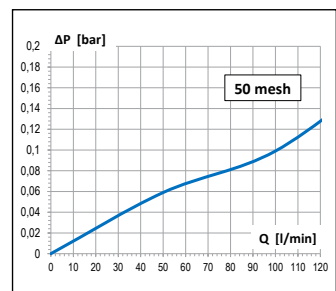

Part No.	F	H	I/1'	Mesh	Screen Material	Effective Area	Pack
		mm				cm ² Sq.in.	
8075006				16		177,8 27,6	
8075000	G 1¼ M	27	120	32	INOX	138 21,4	20
8075001				50		126 19,5	
8075002				80		115 17,8	
8075007				16		177,8 27,6	
8075003	G 1¼ M	40	120	32	INOX	138 21,4	20
8075004				50		126 19,5	
8075005				80		115 17,8	

SPARE PARTS

Part No.	Screen Mesh	Screen Material
C00100069	16	
C00100011	32	INOX
C00100012	50	
C00100013	80	

Part No.	Gasket Material
G00001040	O-Ring EPDM

DIMENSIONS

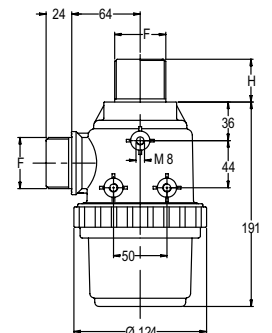

Filtri di aspirazione per portate fino a 100 l/min.

Suction filters for flow rates up to 100 l/min (26 USGpm).

Filtres d'aspiration pour débits jusqu'à 100 l/min.

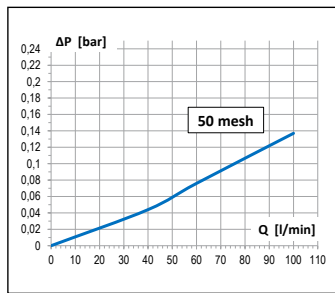
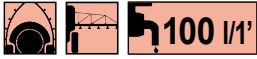

Part No.	F	H	I/1'	Mesh	Screen Material	Effective Area	Pack
		mm				cm ² Sq.in.	
8074000				32	INOX	105 16,3	
8074001				50	INOX	97 15	
8074002	G 1¼ M	24	100	18	PP	90 14	20
8074003				32	PP	69 10,7	
8074008				100	INOX	94 14,5	
8074004				32	INOX	105 16,3	
8074005				50	INOX	97 15	
8074006	G 1¼ M	40	100	18	PP	90 14	20
8074007				32	PP	69 10,7	
8074009				100	INOX	94 14,5	

SPARE PARTS

Part No.	Screen Mesh	Screen Material
C00100020	32	INOX
C00100021	50	
C00100036	100	
C00100022	18	PP
C00100023	32	

Part No.	Gasket Material
G00001034	O-Ring EPDM

DIMENSIONS

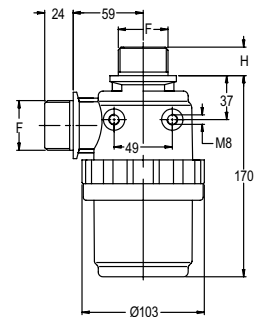

Filtri di aspirazione per portate fino a 150 l/min.

Suction filters for flow rates up to 150 l/min (40 USGpm).

Filtres d'aspiration pour débits jusqu'à 150 l/min.

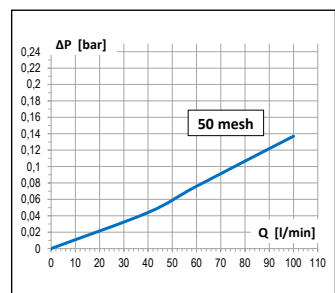
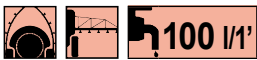

Part No.	F	I/1'	Mesh	Screen Material	Effective Area	Pack
					cm ² Sq.in.	
8074017			18	PP	90 14	
8074018			32	PP	69 10,7	
8074014	AF5	100	32	INOX	105 16,3	20
8074015			50	INOX	97 15	
8074016			100	INOX	94 14,5	

SPARE PARTS

Part No.	Screen Mesh	Screen Material
C00100020	32	INOX
C00100021	50	
C00100036	100	
C00100022	18	PP
C00100023	32	

Part No.	Gasket Material
G00001034	O-Ring EPDM

DIMENSIONS

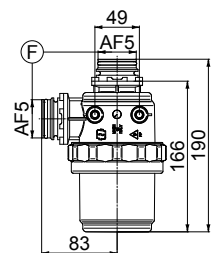

OPTIONALS

AF FORK FITTINGS Pag. 180 - 181

Filtri di aspirazione per portate fino a 60 l/min.

Suction filters for flow rates up to 60 l/min
(16 USGpm).

Filtres d'aspiration pour débits jusqu'à 60 l/min.

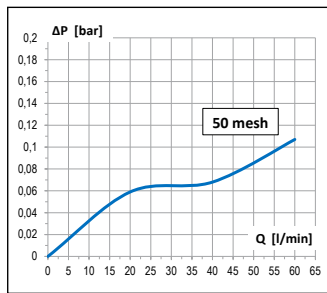
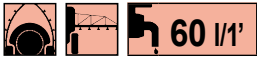

Part No.	F	H	I/1'	Mesh	Screen Material	Effective Area	Pack
		mm				cm ² Sq.in.	
8072000				32	INOX	66 10,3	
8072001	G 1¼ M	24	60	50	INOX	61 9,4	20
8072002				18	PP	56 8,7	
8072003				32	PP	43 6,7	
8072004				32	INOX	66 10,3	
8072005	G 1¼ M	40	60	50	INOX	61 9,4	20
8072006				18	PP	56 8,7	
8072007				32	PP	43 6,7	

SPARE PARTS

Part No.	Screen Mesh	Screen Material
C00100024	32	INOX
C00100025	50	INOX
C00100026	18	PP
C00100027	32	PP

Part No.	Gasket Material
G00001034	O-Ring EPDM

DIMENSIONS

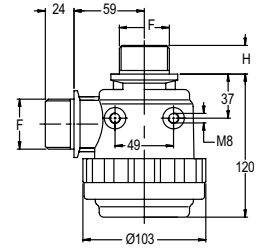

Filtri di aspirazione per portate fino a 60 l/min.

Suction filters for flow rates up to 60 l/min
(16 USGpm).

Filtres d'aspiration pour débits jusqu'à 60 l/min.

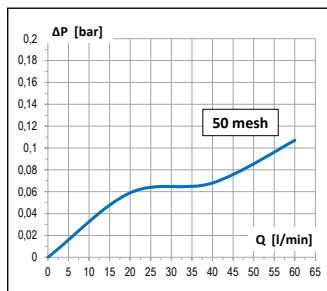
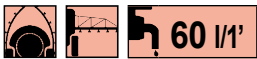

Part No.	F	I/1'	Mesh	Screen Material	Effective Area	Pack
					cm ² Sq.in.	
8072010			18	PP	56 8,7	
8072011	AF5	60	32	PP	43 6,7	20
8072008			32	INOX	66 10,3	
8072009			50	INOX	61 9,4	

SPARE PARTS

Part No.	Screen Mesh	Screen Material
C00100024	32	INOX
C00100025	50	INOX
C00100026	18	PP
C00100027	32	PP

Part No.	Gasket Material
G00001034	O-Ring EPDM

DIMENSIONS

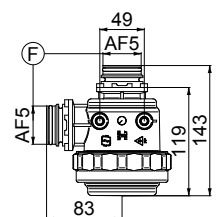

OPTIONALS

AF FORK FITTINGS Pag. 180 - 181

Filtri di mandata per pressioni di esercizio fino a 15 bar. *Line filters for pressures up to 15 bar (220 PSI).* *Filtres en ligne pour pressions jusqu'à 15 bar.*

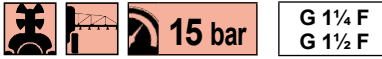

Part No.	F	I/I'	bar	Mesh	Screen Material	Effective Area		Pack
						cm ²	Sq.in.	
8121000				32		116	18	
8121001	G 1 1/4 F	200	15	50	INOX	106	16,4	5
8121002				80		97	15	
8121003				100		103	16	
8121004				32		116	18	
8121005	G 1 1/2 F	280	15	50	INOX	106	16,4	5
8121006				80		97	15	
8121007				100		103	16	

SPARE PARTS

Part No.	Screen Mesh	Screen Material
C00100032	32	INOX
C00100033	50	
C00100034	80	
C00100035	100	

Part No.	Gasket Material
G00001046	O-Ring EPDM

DIMENSIONS

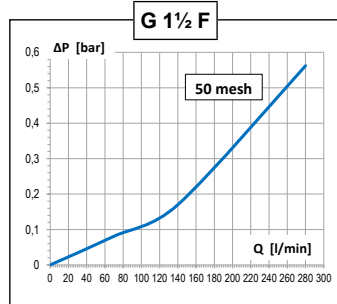
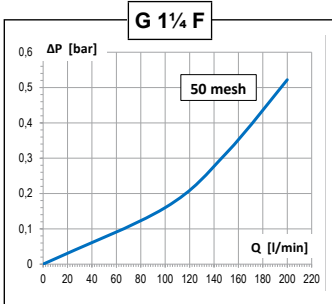
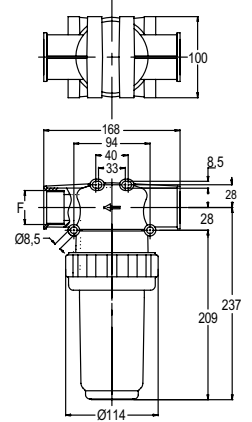

Filtri di mandata per pressioni di esercizio fino a 15 bar. *Line filters for pressures up to 15 bar (220 PSI).* *Filtres en ligne pour pressions jusqu'à 15 bar.*



COLOR CODING

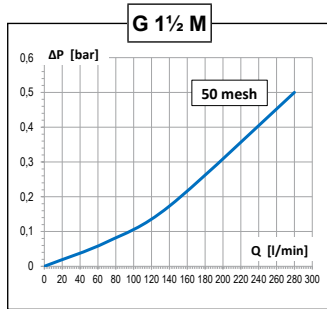
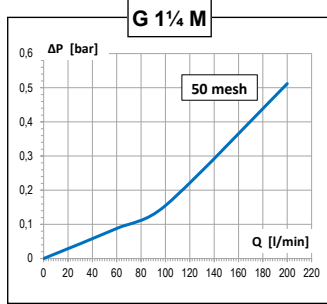

Part No.	F	I/1'	bar	Mesh	Screen Material	Effective Area cm ² Sq.in.	Pack
8127000				32		116 18	
8127001	G 1 1/4 M	200	15	50	INOX	106 16,4	5
8127002				80		97 15	
8127003				100		103 16	
8127004				32		116 18	
8127005	G 1 1/2 M	280	15	50	INOX	106 16,4	5
8127006				80		97 15	
8127007				100		103 16	

SPARE PARTS

Part No.	Screen Mesh	Screen Material
C00100032	32	INOX
C00100033	50	
C00100034	80	
C00100035	100	

Part No.	Gasket Material
G00001046	O-Ring EPDM

DIMENSIONS

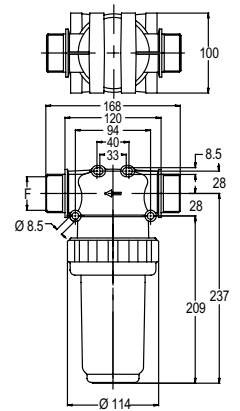

Filtri di mandata per pressioni di esercizio fino a 15 bar. *Line filters for pressures up to 15 bar (220 PSI).* *Filtres en ligne pour pressions jusqu'à 15 bar.*

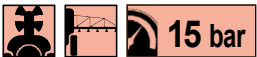

COLOR CODING

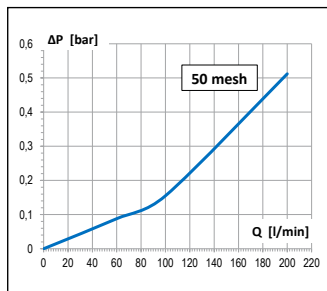

Part No.	F	I/1'	Mesh	Screen Material	Effective Area cm ² Sq.in.	Pack
8127020			32		116 18	
8127021	AF5	280	50	INOX	106 16,4	15
8127022			80		97 15	
8127023			100		103 16	

SPARE PARTS

Part No.	Screen Mesh	Screen Material
C00100032	32	INOX
C00100033	50	
C00100034	80	
C00100035	100	

Part No.	Gasket Material
G00001046	O-Ring EPDM

DIMENSIONS

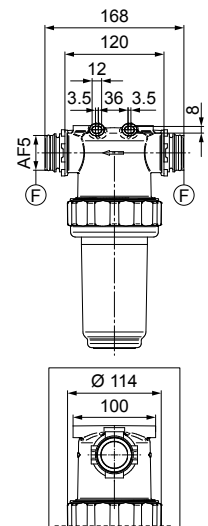

OPTIONALS

AF5 FORK FITTINGS Pag. 180 - 181

Filtri di mandata per pressioni di esercizio fino a 20 bar.

Line filters for pressures up to 20 bar (290 PSI).

Filtres en ligne pour pressions jusqu'à 20 bar.



SPARE PARTS

Part No.	Screen Mesh	Screen Material
C00100000	32	INOX
C00100001	50	
C00100002	80	
C00100003	100	

Part No.	Gasket Material
G00001024	O-Ring EPDM

DIMENSIONS

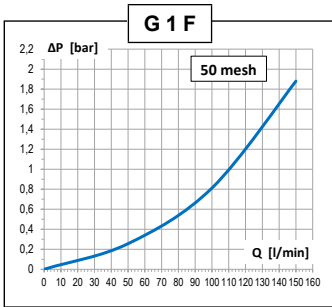
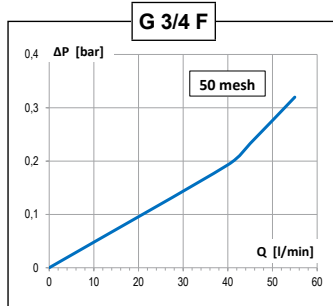
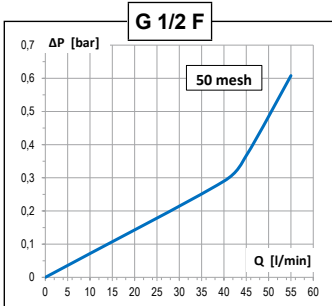
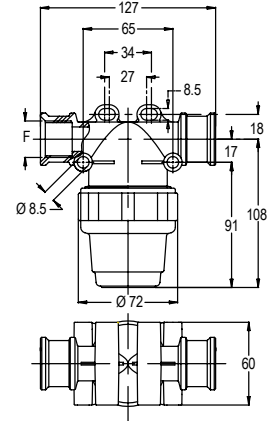

Part No.	F	l/1'	bar	Mesh	Screen Material	Effective Area cm ²	Sq.in.	Pack
8105000	G 1/2 F	80	20	32	INOX	26	4	25
8105001				50		24	3,7	
8105002				80		22	3,4	
8105003				100		23	3,6	
8105004	G 3/4 F	100	20	32	INOX	26	4	25
8105005				50		24	3,7	
8105006				80		22	3,4	
8105007				100		23	3,6	
8105008	G 1 F	150	20	32	INOX	38	5,9	25
8105009				50		35	5,4	
8105010				80		32	5	
8105011				100		34	5,3	



SPARE PARTS

Part No.	Screen Mesh	Screen Material
C00100004	32	INOX
C00100005	50	
C00100006	80	
C00100007	100	

Part No.	Gasket Material
G00001024	O-Ring EPDM

DIMENSIONS

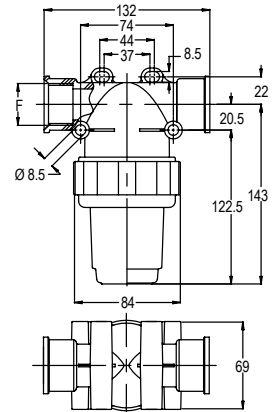

Filtri di mandata per pressioni di esercizio fino a 20 bar. *Line filters for pressures up to 20 bar (290 PSI).* *Fitres en ligne pour pressions jusqu'à 20 bar.*

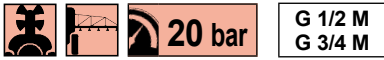

Part No.	F	I/1'	bar	Mesh	Screen Material	Effective Area cm ² Sq.in.	Pack
8110000				32		26 4	
8110001	G 1/2 M	80	20	50	INOX	24 3,7	25
8110002				80		22 3,4	
8110003				100		23 3,6	
8110004				32		26 4	
8110005	G 3/4 M	100	20	50	INOX	24 3,7	25
8110006				80		22 3,4	
8110007				100		23 3,6	

SPARE PARTS

Part No.	Screen Mesh	Screen Material
C00100000	32	
C00100001	50	INOX
C00100002	80	
C00100003	100	

Part No.	Gasket Material
G00001024	O-Ring EPDM

DIMENSIONS

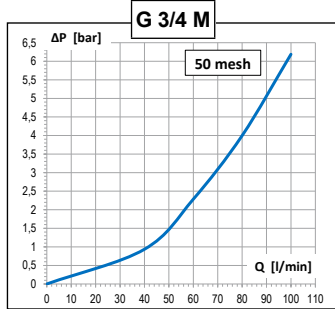
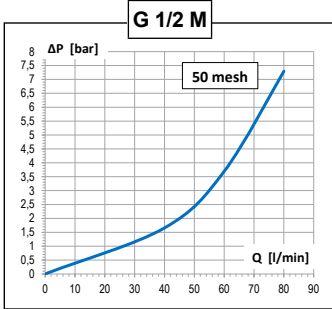
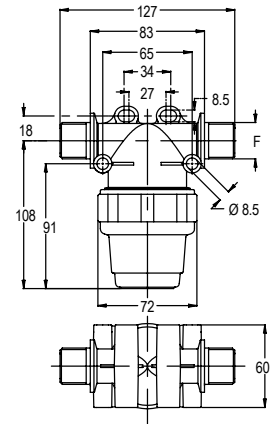

Filtri di mandata per pressioni di esercizio fino a 15 bar. *Line filters for pressures up to 15 bar (220 PSI).* *Fitres en ligne pour pressions jusqu'à 15 bar.*

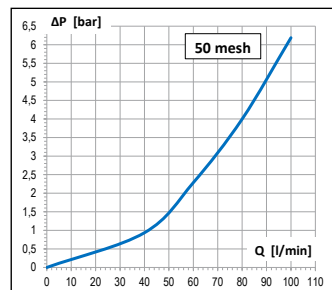

Part No.	F	I/1'	Mesh	Screen Material	Effective Area cm ² Sq.in.	Pack
8110022			32		26 4	
8110023	AF3	100	50	INOX	24 3,7	15
8110024			80		22 3,4	
8110025			100		23 3,6	

SPARE PARTS

Part No.	Screen Mesh	Screen Material
C00100000	32	
C00100001	50	INOX
C00100002	80	
C00100003	100	

Part No.	Gasket Material
G00001024	O-Ring EPDM

DIMENSIONS

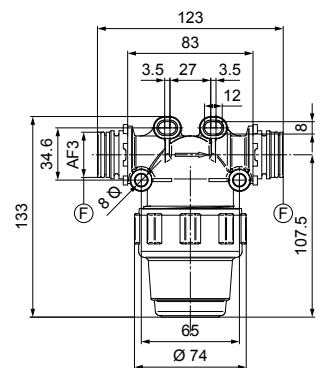

OPTIONALS

AF3 FORK FITTINGS Pag. 180 - 181

Filtri di mandata per pressioni di esercizio fino a 20 bar. *Line filters for pressures up to 20 bar (290 PSI).* *Filtres en ligne pour pressions jusqu'à 20 bar.*

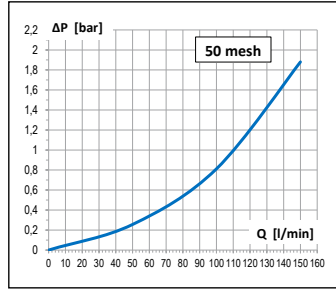

Part No.	F	I/1'	bar	Mesh	Screen Material	Effective Area cm ² Sq.in.	Pack
8110008				32		38 5,9	
8110009	G 1 M	150	20	50	INOX	35 5,4	25
8110010				80		32 5	
8110011				100		34 5,3	

SPARE PARTS

Part No.	Screen Mesh	Screen Material
C00100004	32	INOX
C00100005	50	
C00100006	80	
C00100007	100	

Part No.	Gasket Material
G00001024	O-Ring EPDM

DIMENSIONS

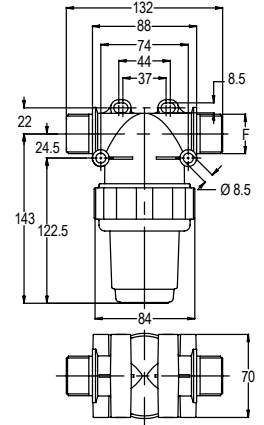

Filtri di mandata per pressioni di esercizio fino a 15 bar. *Line filters for pressures up to 15 bar (220 PSI).* *Filtres en ligne pour pressions jusqu'à 15 bar.*

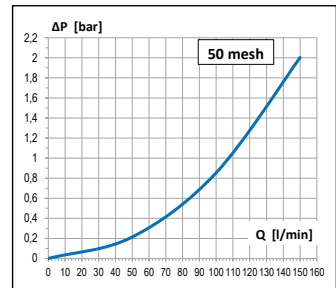

Part No.	F	I/1'	Mesh	Screen Material	Effective Area cm ² Sq.in.	Pack
8110018			32		38 5,9	
8110019	AF4	150	50	INOX	35 5,4	15
8110020			80		32 5	
8110021			100		34 5,3	

SPARE PARTS

Part No.	Screen Mesh	Screen Material
C00100004	32	INOX
C00100005	50	
C00100006	80	
C00100007	100	

Part No.	Gasket Material
G00001024	O-Ring EPDM

DIMENSIONS

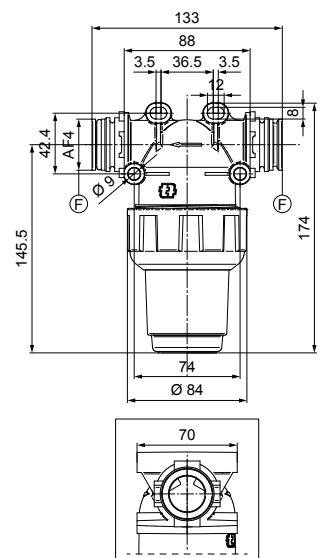

Filtri di mandata autopulenti per pressioni di esercizio fino a 15 bar con filetti femmina.

Self-cleaning line filters for pressures up to 15 bar (220 PSI) - female threads.

Filtres en ligne autonettoyants pour pressions jusqu'à 15 bar - filetage femelle.



Part No.	F	I/1'	bar	Mesh	Screen Material	Effective Area cm ² Sq.in.	Pack
8122000				32		116 18	
8122001	G 1¼ F	200	15	50	INOX	106 16,4	5
8122002				80		97 15	
8122003				100		103 16	
8122004				32		116 18	
8122005	G 1½ F	280	15	50	INOX	106 16,4	5
8122006				80		97 15	
8122007				100		103 16	

SPARE PARTS

Part No.	Screen Mesh	Screen Material
C00100032	32	INOX
C00100033	50	INOX
C00100034	80	INOX
C00100035	100	INOX

Part No.	Gasket Material
G00001046	O-Ring EPDM

DIMENSIONS

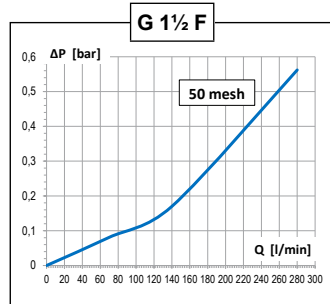
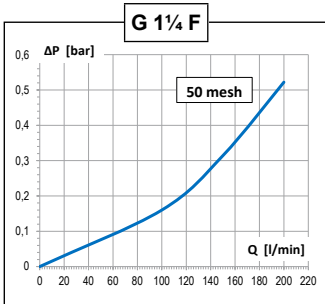
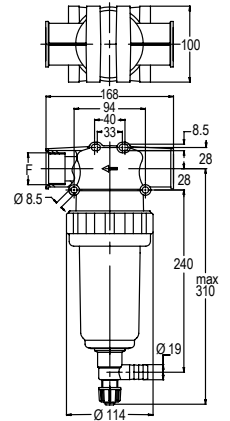

Filtri di mandata autopulenti per pressioni di esercizio fino a 15 bar con filetti maschio.

Self-cleaning line filters for pressures up to 15 bar (220 PSI) - male threads.

Filtres en ligne autonettoyants pour pressions jusqu'à 15 bar - filetage mâle.

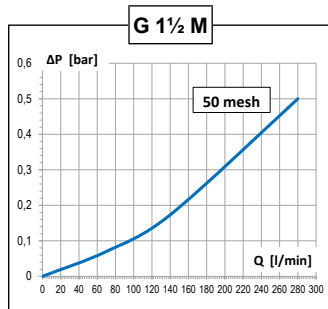
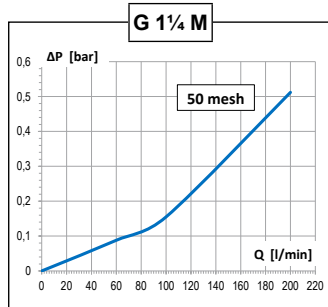

Part No.	F	I/1'	bar	Mesh	Screen Material	Effective Area cm ² Sq.in.	Pack
8128000				32		116 18	
8128001	G 1 1/4 M	200	15	50	INOX	106 16,4	5
8128002				80		97 15	
8128003				100		103 16	
8128004				32		116 18	
8128005	G 1 1/2 M	280	15	50	INOX	106 16,4	5
8128006				80		97 15	
8128007				100		103 16	

SPARE PARTS

Part No.	Screen Mesh	Screen Material
C00100032	32	INOX
C00100033	50	
C00100034	80	
C00100035	100	

Part No.	Gasket Material
G00001046	O-Ring EPDM

DIMENSIONS

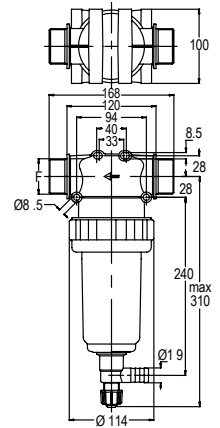

Filtri di mandata autopulenti per pressioni di esercizio fino a 15 bar.

Self-cleaning line filters for pressures up to 15 bar (220 PSI).

Filtres en ligne autonettoyants pour pressions jusqu'à 15 bar.

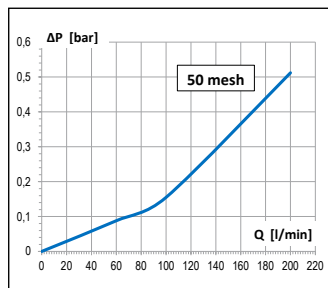
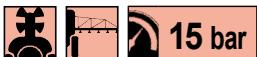

Part No.	F	I/1'	Mesh	Screen Material	Effective Area cm ² Sq.in.	Pack
8128022			32		116 18	
8128023	AF5	280	50	INOX	106 16,4	15
8128024			80		97 15	
8128025			100		103 16	

SPARE PARTS

Part No.	Screen Mesh	Screen Material
C00100032	32	INOX
C00100033	50	
C00100034	80	
C00100035	100	

Part No.	Gasket Material
G00001046	O-Ring EPDM

DIMENSIONS

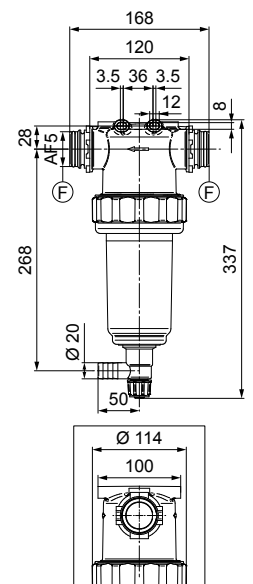

OPTIONALS

AF FORK FITTINGS Pag. 180 - 181

3 FILTRI DI ASPIRAZIONE E MANDATA

SUCTION AND LINE FILTERS / RACCORDE EN POLYPROPYLENE



Filtri di mandata autopulenti per pressioni di esercizio fino a 20 bar con filetti maschio.

Self-cleaning line filters for pressures up to 20 bar (220 PSI) - male threads.

Filtres en ligne autonettoyants pour pressions jusqu'à 20 bar - filetage mâle.

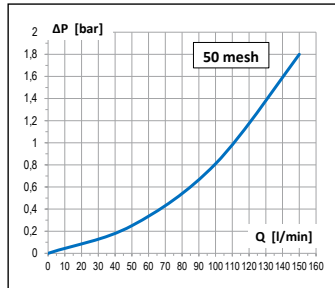

Part No.	F	l/1'	bar	Mesh	Screen Material	Effective Area cm ²	Sq.in.	Pack
8111000				32		38	5,9	
8111001	G 1 M	150	20	50	INOX	35	5,4	10
8111002				80		32	5	
8111003				100		34	5,3	

SPARE PARTS

Part No.	Screen Mesh	Screen Material
C00100004	32	INOX
C00100005	50	INOX
C00100006	80	INOX
C00100007	100	INOX

Part No.	Gasket Material
G00001024	O-Ring EPDM

DIMENSIONS

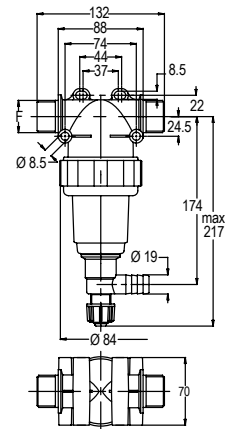

Filtri di mandata autopulenti per pressioni di esercizio fino a 15 bar.

Self-cleaning line filters for pressures up to 15 bar (220 PSI).

Filtres en ligne autonettoyants pour pressions jusqu'à 15 bar.

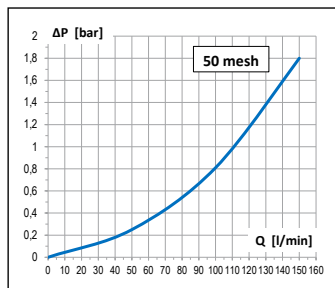

Part No.	F	l/1'	Mesh	Screen Material	Effective Area cm ²	Sq.in.	Pack
8111004			32		38	5,9	
8111005	AF4	150	50	INOX	35	5,4	15
8111006			80		32	5	
8111007			100		34	5,3	

SPARE PARTS

Part No.	Screen Mesh	Screen Material
C00100004	32	INOX
C00100005	50	INOX
C00100006	80	INOX
C00100007	100	INOX

Part No.	Gasket Material
G00001024	O-Ring EPDM

DIMENSIONS

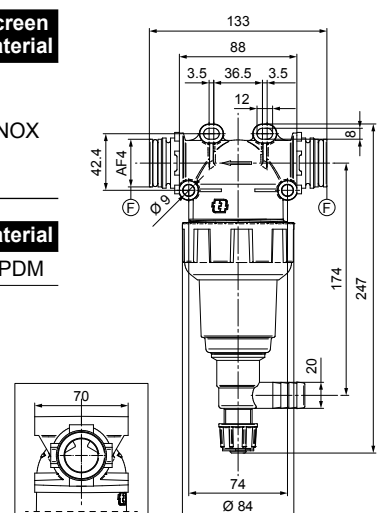

3 FILTRI DI ASPIRAZIONE E MANDATA

SUCTION AND LINE FILTERS / RACCORDE EN POLYPROPYLENE



Filtri di mandata autopulenti per pressioni di esercizio fino a 20 bar con filetti femmina.

Self-cleaning line filters for pressures up to 20 bar (220 PSI) - female threads.

Filtres en ligne autonettoyants pour pressions jusqu'à 20 bar - filetage femelle.

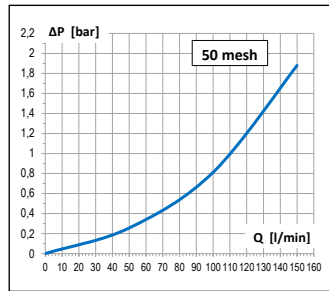

Part No.	F	I/1'	bar	Mesh	Screen Material	Effective Area cm ²	Sq.in.	Pack
8106000				32		38	5,9	
8106001	G 1 F	150	20	50	INOX	35	5,4	10
8106002				80		32	5	
8106003				100		34	5,3	

SPARE PARTS

Part No.	Screen Mesh	Screen Material
C00100004	32	
C00100005	50	INOX
C00100006	80	
C00100007	100	

Part No.	Gasket Material
G00001024	O-Ring EPDM

DIMENSIONS

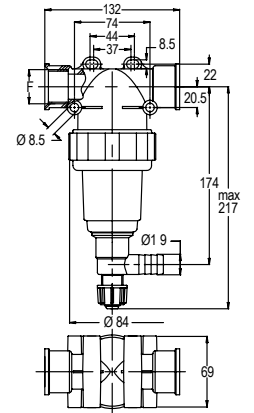

Filtri di mandata per pressioni di esercizio fino a 10 bar (220 PSI). Con filetti femmina.

Line filters for pressures up to 10 bar (145 PSI). Female threads.

Filtres en ligne pour pressions jusqu'à 10 bar (220 PSI). Filetage femelle.



COLOR CODING

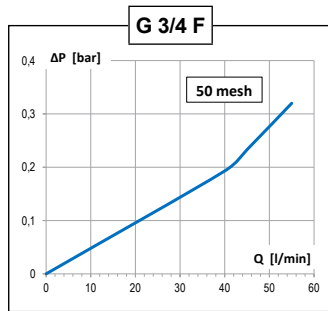
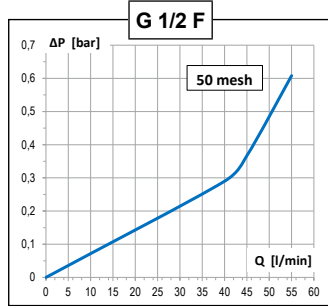

Part No.	F	1/1'	bar	Mesh	Screen Material	Effective Area cm ² Sq.in.	Pack
8105032				32		25,6 4,0	
8105033	G 1/2 F	55	10	50	INOX	23,5 3,6	10
8105034				80		25,6 4,0	
8105035				100		21,5 3,3	
8105024				32		25,6 4,0	
8105025	G 3/4 F	55	10	50	INOX	23,5 3,6	10
8105026				80		25,6 4,0	
8105027				100		21,5 3,3	

SPARE PARTS

Part No.	Screen Mesh	Screen Material
C00100057	32	INOX
C00100058	50	
C00100059	80	
C00100060	100	

Part No.	Gasket Material
G00002052	O-Ring EPDM

DIMENSIONS

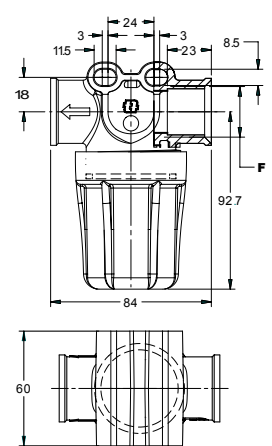

COLOR CODING

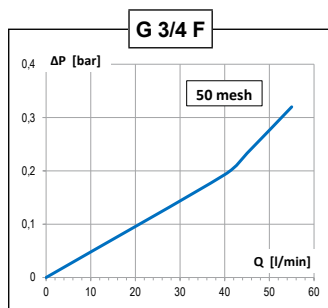
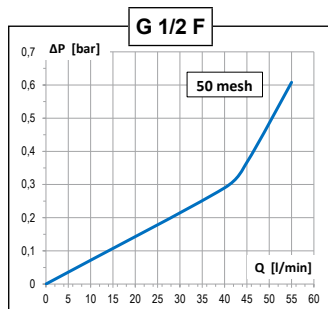

Part No.	F	1/1'	bar	Mesh	Screen Material	Effective Area cm ² Sq.in.	Pack
8105036				32		25,6 4,0	
8105037	G 1/2 F	55	10	50	INOX	23,5 3,6	10
8105038				80		25,6 4,0	
8105039				100		21,5 3,3	
8105040				32		25,6 4,0	
8105041	G 3/4 F	55	10	50	INOX	23,5 3,6	10
8105042				80		25,6 4,0	
8105043				100		21,5 3,3	

SPARE PARTS

Part No.	Screen Mesh	Screen Material
C00100057	32	INOX
C00100058	50	
C00100059	80	
C00100060	100	

Part No.	Gasket Material
G00002052	O-Ring EPDM

DIMENSIONS

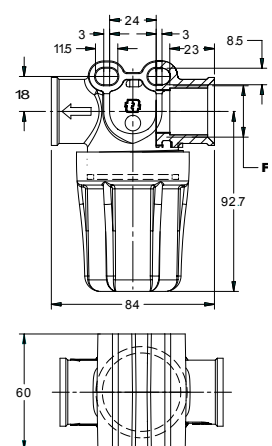

Filtri di mandata per pressioni di esercizio fino a 15 bar (220 PSI). Con filetti maschio.

Line filters for pressures up to 15 bar (220 PSI). With male threads.

Filtres en ligne pour pressions jusqu'à 15 bar (220 PSI). Avec filetage mâle.



Part No.	F	l/1'	bar	Mesh	Screen Material	Effective Area cm ²	Sq.in.	Pack
8118000				32		38	5,9	
8118001	G 1/2 M	80	15	50	INOX	35	5,4	10
8118002				80		32	5	
8118003				100		34	5,3	
8118004				32		38	5,9	
8118005	G 3/4 M	100	15	50	INOX	35	5,4	10
8118006				80		32	5	
8118007				100		34	5,3	
8118008				32		38	5,9	
8118009	G 1 M	150	15	50	INOX	35	5,4	10
8118010				80		32	5	
8118011				100		34	5,3	

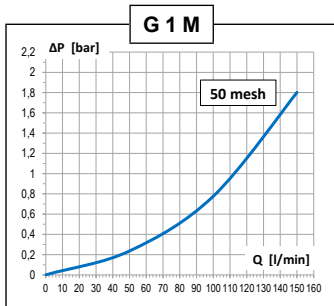
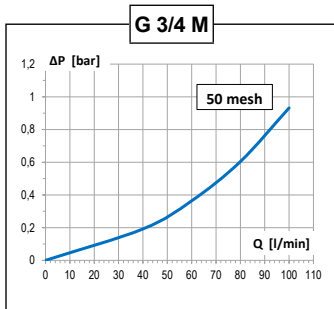
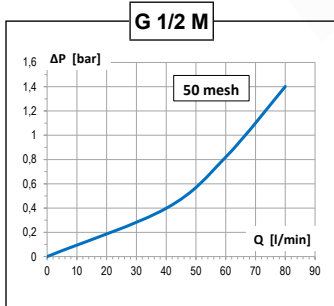

SPARE PARTS

Part No.	Screen Mesh	Screen Material
C00100004	32	INOX
C00100005	50	
C00100006	80	
C00100007	100	

Part No.	Gasket Material
G00001024	O-Ring EPDM

DIMENSIONS

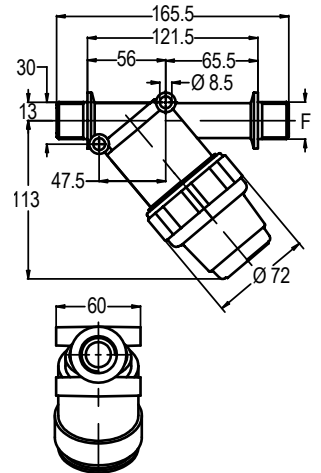

Filtri galleggianti di aspirazione

- Filtro galleggiante realizzato in materiale plastico antiurto.
 - Il raccordo girevole (da ordinare a parte) garantisce un perfetto galleggiamento del filtro anche con tubo di collegamento attorcigliato.

Floating filters

- Suction floating filter in shock-resistant plastic.
 - The swivel fitting (to be ordered separately) assures the perfect floating even in case of twisted pipe.

Filtres flottants d'aspiration

- Filtre flottant d'aspiration fabriqué en plastique antichoc.
 - Le raccord tournant (à commander séparément) assure le flottement parfait du filtre, même en cas de tuyau d'aspiration entortillé.

Ordinare il raccordo separatamente
 Fitting to be ordered separately
 Commander le raccord séparément

Part No.	F mm	Pack
R0000020	33	5
R0000021	35	
R0000022	40	
R0000023	50	



Part No.	Pack
8062003	4

DIMENSIONS

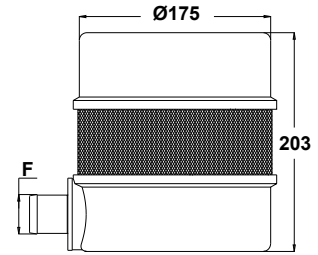

Cestini di fondo.

Foot filters.

Filtres de fond.

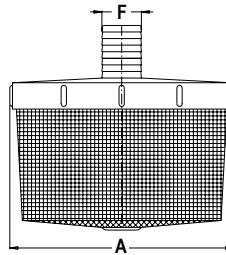

Part No.	A mm	F mm	Type	Pack
8060000	100	15		25
8060001		20		25
8060002	137	20		25
8060003		25		25
8060004		30		10
8060005	137	30		10
8060006		35		
8060007		40		

Filtri di aspirazione per detersivo (con contrappeso).

Suction filters for detergents (with counterweight).

Filtres d'aspiration pour détergents (avec contrepoids).

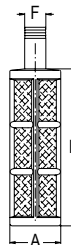

Part No.	F mm	A mm	B mm	Screen Mesh	Pack
8064000	8	22	40	40	10

Filtri di aspirazione

Suction filters

Filtres d'aspiration



Part No.	F mm	A mm	B mm	Screen Mesh	Pack
8064002	19	42	65	30	10
8064003	25	42	65	30	10

Filtri di mandata per portate fino a 150 l/min e pressioni fino a 50 bar.

Line filters for flow rates up to 150 l/min (40 USGpm) and pressure up to 50 bar (720 PSI).

Filtres en ligne pour débits jusqu'à 150 l/min et pressions jusqu'à 50 bar.



Part No.	F	l/1'	bar	Mesh	Screen Material	Effective Area cm ²	Sq. in.	Pack
8135000				32		70	10,9	
8135001	G 3/4 F	150	50	50	INOX	64	10	5
8135002				80		59	9,1	
8135009				100		59,2	9,2	

SPARE PARTS

Part No.	Screen Mesh	Screen Material
C00100014	32	INOX
C00100015	50	
C00100016	80	
C00100073	100	

Part No.	Gasket	Material
G00001032	O-Ring	EPDM

DIMENSIONS

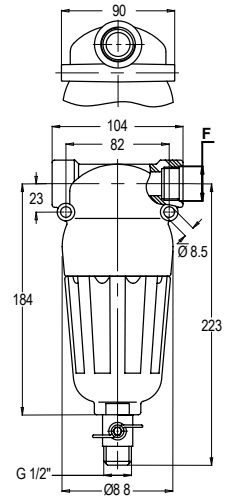

Tappo in ottone

Brass plug

Bouchon en laiton

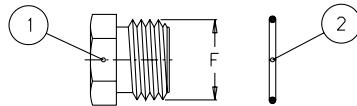

Part No. 1	Part No. 2	F	Pack
8304000	G00001058	G 3/4 M	10

Nipplo in ottone

Brass nipple

Adaptateur en laiton

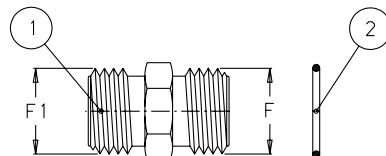

Part No. 1	Part No. 2	F	F1	Pack
8304001	G00001058	G 3/4 M	G 1/2 M	10
8304002	G00001058	G 3/4 M	G 3/4 M	10

Filtri di mandata in ottone per portate fino a 70 l/min e pressioni fino a 50 bar.

Brass line filters for flow rates up to 70 l/min (18.5 USGpm) and pressure up to 50 bar (720 PSI).

Filtres en ligne en laiton pour débits jusqu'à 70 l/min et pressions jusqu'à 50 bar.



Part No.	F	l/1'	bar	Mesh	Screen Material	Pack
8137009				30	INOX	
8137008	G 1/2 F	70	50	40	INOX	5
8137010				70	INOX	
8137021				100	INOX	

SPARE PARTS

Part No.	Screen Mesh	Screen Material
C00100051	30	INOX
C00100042	40	
C00100052	70	
C00100075	100	

DIMENSIONS

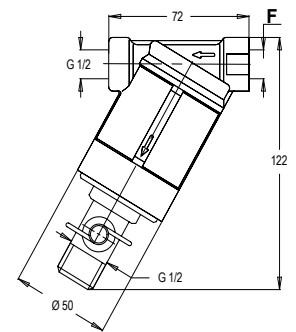

Filtri di mandata in ottone per portate fino a 70 l/min e pressioni fino a 50 bar.

Brass line filters for flow rates up to 70 l/min (18.5 USGpm) and pressure up to 50 bar (720 PSI).

Filtres en ligne en laiton pour débits jusqu'à 70 l/min et pressions jusqu'à 50 bar.

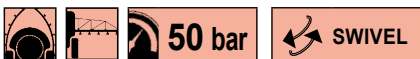

Part No.	F	l/1'	bar	Mesh	Screen Material	Pack
8137011				30	INOX	
8137004	G 1/2 F	70	50	40	INOX	5
8137012				70	INOX	
8137022				100	INOX	

SPARE PARTS

Part No.	Screen Mesh	Screen Material
C00100051	30	INOX
C00100042	40	
C00100052	70	
C00100075	100	

DIMENSIONS

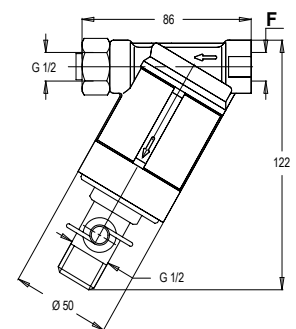

Filtri di mandata in ottone per portate fino a 150 l/min e pressioni fino a 50 bar.

Brass line filters for flow rates up to 150 l/min (40 USGpm) and pressure up to 50 bar (720 PSI).

Filtres en ligne en laiton pour débits jusqu'à 150 l/min et pressions jusqu'à 50 bar.



Part No.	F	I/1'	bar	Mesh	Screen Material	Effective Area cm ²	Sq.in.	Pack
8137006				30				
8137007	G 3/4 F	150	50	40	INOX	145	22	5
8137015				80				
8137016				100				
8137013				30				
8137014	G 1/2 F	150	50	40	INOX	145	22	5
8137017				80				
8137018				100				

SPARE PARTS

Part No.	Screen Mesh	Screen Material
C00100043	30	INOX
C00100044	40	INOX
C00100053	80	INOX
C00100054	100	INOX

DIMENSIONS

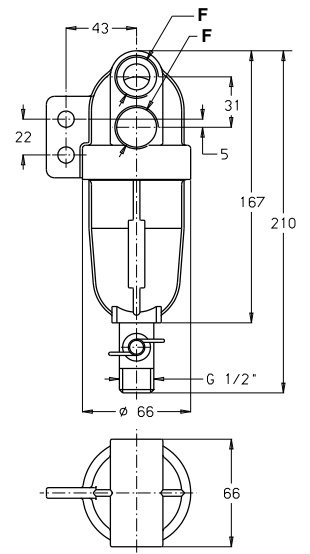

Filtro a siluro per portate fino a 110 l/min e pressioni fino a 50 bar.

"Torpedo" filter for flow rates up to 110 l/min (29 USGpm), max. pressure 50 bar (720 PSI).

Filtre à "torpille" pour débit jusqu'à 110 l/min et pressions jusqu'à 50 bar.



Part No.	F	I/1'	bar	Mesh	Screen Material	Pack
8137005	G 1/2 M	110	50	40	INOX	5

SPARE PARTS

Part No.	Screen Mesh	Screen Material
C00100041	40	INOX

DIMENSIONS

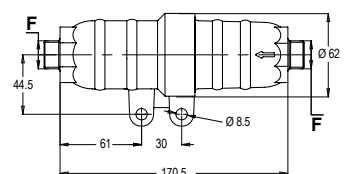

3 FILTRI DI ASPIRAZIONE E MANDATA

SUCTION AND LINE FILTERS / RACCORDS EN POLYPROPYLENE



Filtri di mandata in ottone per portate fino a 30 l/min e pressioni fino a 15 bar.

Brass line filters for flow rates up to 30 l/min (8 USGpm) and pressure up to 15 bar (220 PSI).

Filtres en ligne en laiton pour débits jusqu'à 30 l/min et pressions jusqu'à 15 bar.



Part No.	F	l/1'	bar	Mesh	Pack
0211000520	G 1/2 F	30	15	45	10
0211000530	G 3/4 F				

Filtri di mandata in ottone per portate fino a 30 l/min e pressioni fino a 310 bar.

Brass line filters for flow rates up to 30 l/min (8 USGpm) and pressure up to 310 bar (4550 PSI).

Filtres en ligne en laiton pour débits jusqu'à 30 l/min et pressions jusqu'à 310 bar.



Part No.	F	F1	l/1'	bar	Mesh	Screen Material	Pack
0211000660	G 1/4 F	R 1/4 M	30	310	110	INOX	5



LEGENDA

FEATURES



Prodotti non per uso alimentare
Products not for food use
Produits non pour un usage alimentaire

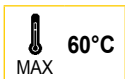

Temperatura massima
Max temperature
Temperature maxi

RACCORDERIA IN POLIPROPILENE 4

POLYPROPYLENE FITTINGS / RACCORDE EN POLYPROPYLÈNE

Raccorderia in polipropilene

La raccorderia GEOLINE è realizzata in polipropilene (altri materiali a richiesta) e Guarnizioni in EPDM (Viton® a richiesta).

I Girelli, le Ghiere e i tappi GEOLINE sono realizzati in polipropilene rinforzato con fibra di vetro (altri materiali a richiesta) e Guarnizioni in EPDM (Viton® a richiesta).

Le filettature GEOLINE sono conformi alle normative BSP (altre filettature a richiesta).

Polypropylene fittings

GEOLINE fittings are made of polypropylene (other materials on demand), with EPDM Gaskets (Viton® on demand).

GEOLINE fly nuts, back nuts and cups are made of fiberglass reinforced polypropylene (other materials on demand), with EPDM Gaskets (Viton® on demand).

GEOLINE threads comply with BSP standards (other threads on demand).

Raccords en polypropylène

Tous les raccords GEOLINE sont en polypropylène (autres matériaux sur demande), et les joints en EPDM (Viton® sur demande).

Les écrous, embouts et bouchons GEOLINE sont en polypropylène renforcé par fibres de verre (autres matériaux sur demande), avec les joints en EPDM (Viton® sur demande).

Les filetages GEOLINE sont conformes aux normes BSP (autres filetages sur demande).



Portagomma dritto attacco a forchetta femmina
 Straight hoesetail with female fork coupling
 Raccord droit avec accouplement à fourche femelle

NYLON

NEW

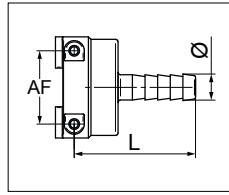
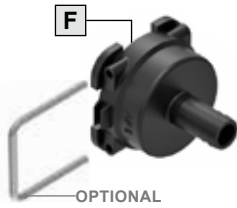

Part No.	AF	Ø mm	L mm	Pack	Fork
8415301		10	48	25	
8415302		13	48	25	
8415303	3	16	48	25	F00000025
8415304		20	54	25	
8415305		25	54	25	
8415501		13	52	25	
8415502		16	52	25	
8415503		20	58	25	
8415504		25	58	25	
8415505	5	30	58	25	F00000029
8415506		32	61	25	
8415507		35	63	25	
8415508		38	69	25	
8415509		40	69	25	

Portagomma curvo 90° attacco a forchetta femmina
 90° hoesetail with female fork coupling
 Raccord coudé à 90° avec accouplement à fourche femelle

NYLON

NEW

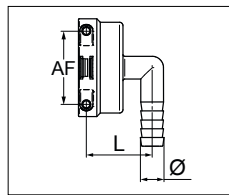
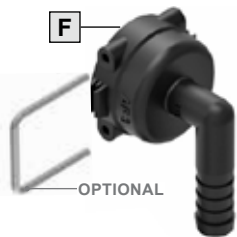

Part No.	AF	Ø mm	L mm	Pack	Fork
8419501		13	38	25	
8419502		16	38	25	
8419503		20	38	25	
8419504		25	38	25	
8419505	5	30	38	25	F00000029
8419506		32	38	25	
8419507		35	38	25	
8419508		38	38	25	
8419509		40	38	25	

Tappo attacco a forchetta femmina
 Female fork coupling plug
 Bouchon pour accouplement à fourche femelle

NYLON

NEW

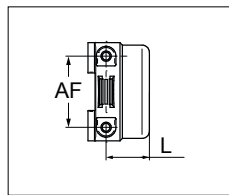
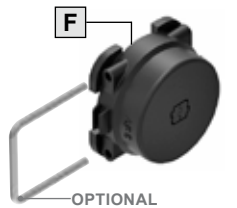

Part No.	AF	L mm	Pack	Fork
8459301	3	18	25	F00000025
8459501	5	21	25	F00000029

Manicotto attacco a forchetta femmina
 Female fork coupling plug
 Manchon pour accouplement à fourche femelle

NYLON

NEW

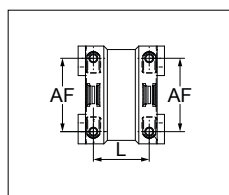
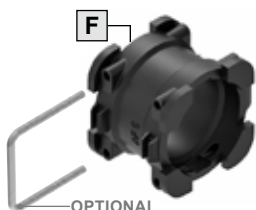

Part No.	AF	L mm	Pack	Fork
8433501	5	32	1	F00000029

Portagomma dritto attacco a forchetta maschio
 Straight hoesetail with male fork coupling
 Raccord droit avec accouplement à fourche mâle

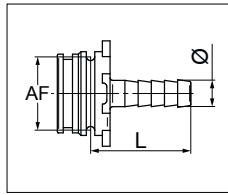
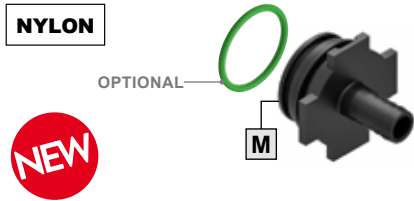

Part No.	AF	Ø mm	L mm	Pack	EPDM	VITON®
					O-ring	O-ring
8416301		10	38	25		
8416302		13	38	25		
8416303	3	16	38	25	G00001020	G00001021
8416304		20	44	25		
8416305		25	44	25		
8416306		30	44	25		
8416501		13	40	25		
8416502		16	40	25		
8416503		20	45	25		
8416504		25	45	25		
8416505	5	30	45	25	G00001277	G00001074
8416506		32	49	25		
8416507		35	51	25		
8416508		38	57	25		
8416509		40	57	25		

Portagomma curvo 90° attacco a forchetta maschio
 90° hoesetail with male fork coupling
 Raccord coudé à 90° avec accouplement à fourche mâle

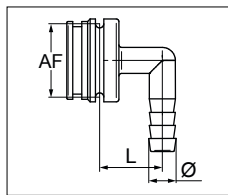
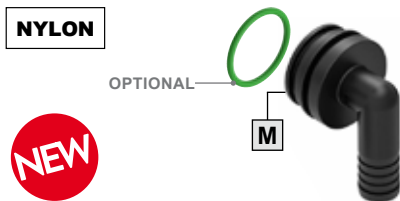

Part No.	AF	Ø mm	L mm	Pack	EPDM	VITON®
					O-ring	O-ring
8420301		10	24	25		
8420302		13	24	25		
8420303	3	16	24	25	G00001020	G00001021
8420304		20	24	25		
8420305		25	24	25		
8420501		13	35	25		
8420502		16	35	25		
8420503		20	35	25		
8420504		25	35	25		
8420505	5	30	35	25	G00001277	G00001074
8420506		32	35	25		
8420507		35	35	25		
8420508		38	35	25		
8420509		40	35	25		

Tappo attacco a forchetta maschio
 Male fork coupling plug
 Bouchon pour accouplement à fourche mâle

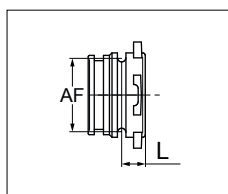
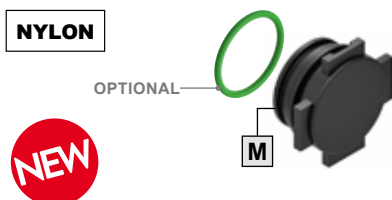

Part No.	AF	L mm	Pack	EPDM	VITON®
				O-ring	O-ring
8460301	3	9	25	G00001020	G00001021
8460501	5	11	25	G00001277	G00001074

Nipplo attacco a forchetta maschio
 Male fork coupling plug
 Nipple pour accouplement à fourche mâle

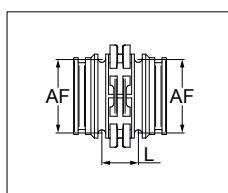
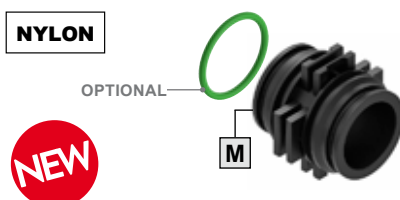

Part No.	AF	L mm	Pack	EPDM	VITON®
				O-ring	O-ring
8434301	5	17	1	G00001277	G00001074
8434501	5	20	1	G00001277	G00001074

Raccordo portagomma diritto per girello
 Hosetail for fly nut
 Raccord droit pour écrou

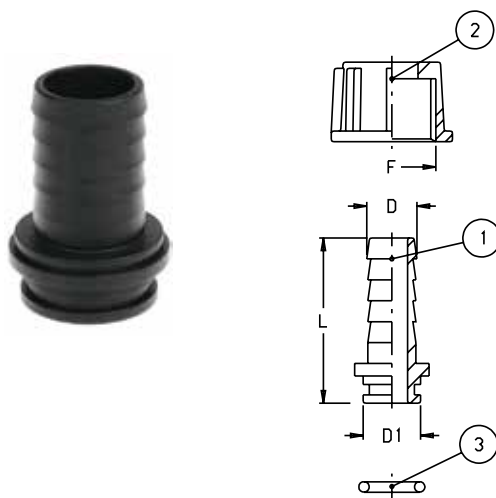

Part No. 1	Part No. 2	Part No. 3	F	D mm	D1 mm	L mm	Pack
8002150	8040151	G00001002	G 1/2	11	13,7	33	25
8002151	8040152	G00001002		13	13,7	33	
8002200	8040201	G00001012		13	17,5	44	
8002201	8040201	G00001012	G 3/4	15	17,5	44	25
8002202	8040202	G00001012		19	17,5	49	
8002250	8040251	G00001018	G 1	13	24,5	49	25
8002251	8040251	G00001018		15	24,5	50	
8002252	8040251	G00001018		19	24,5	51	
8002253	8040251	G00001018		22	24,5	51	
8002254	8040251	G00001018		25	24,5	51	
8002300	8040301	G00001022	G 1 1/4	22	31,5	53	25
8002301	8040301	G00001022		25	31,5	53	
8002302	8040301	G00001022		30	31,5	60	
8002303	8040301	G00001022		32	31,5	63	
8002356	8040351	G00001028	G 1 1/2	15	37,5	38	25
8002350	8040351	G00001028		25	37,5	55	
8002351	8040351	G00001028		30	37,5	62	
8002352	8040351	G00001028		32	37,5	65	
8002353	8040351	G00001028		35	37,5	70	
8002354	8040351	G00001028	38	37,5	72		
8002355	8040351	G00001028	40	37,5	72		
8002400	8040401	G00001030 x2	G 2	40	47	78	10
8002401	8040401	G00001030 x2		45	47	81	
8002402	8040401	G00001030 x2		50	47	84	
8002501	8040501	G00001285 x2	G 3	76	75	90	10

Raccordo portagomma curvo 90° per girello
 90° Hosetail for fly nut
 Raccord coudé à 90° pour écrou

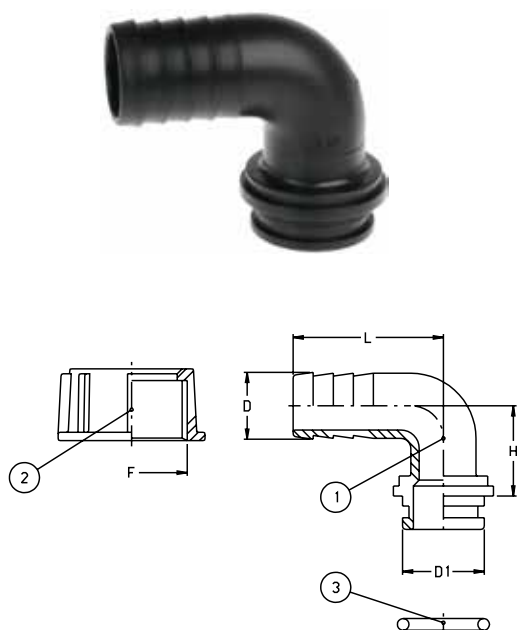

Part No. 1	Part No. 2	Part No. 3	F	D mm	D1 mm	L mm	Pack
8012200	8040202	G00001012	G 3/4	13	17,5	37	25
8012201	8040202	G00001012		15	17,5	40	
8012203	8040202	G00001012		19	17,5	45	
8012250	8040251	G00001018	G 1	15	24,5	40	25
8012251	8040251	G00001018		19	24,5	45	
8012252	8040251	G00001018		25	24,5	53	
8012300	8040301	G00001022	G 1 1/4	22	31,5	53	25
8012301	8040301	G00001022		25	31,5	53	
8012302	8040301	G00001022		30	31,5	60	
8012303	8040301	G00001022		32	31,5	60	
8012350	8040351	G00001028	G 1 1/2	25	37,5	53	25
8012351	8040351	G00001028		30	37,5	60	
8012352	8040351	G00001028		32	37,5	60	
8012353	8040351	G00001028		35	37,5	80	
8012354	8040351	G00001028		38	37,5	85	
8012355	8040351	G00001028	40	37,5	85		
8012400	8040401	G00001030 x2	G 2	40	47	85	10
8012401	8040401	G00001030 x2		45	47	90	
8012402	8040401	G00001030 x2		50	47	90	
8012403	8040401	G00001030 x2		52	47	90	
8012501	8040501	G00001285 x2	G 3	76	75	125	1

Raccordo portagomma diritto con battuta piana per girello
Flat seat hosetail for fly nut
Raccord droit avec siège plat pour écrou

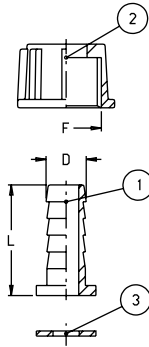

Part No. 1	Part No. 2	Part No. 3	F	D mm	L mm	Pack
8003100	8040101	G00002000	G 3/8	11	37	25
8003150	8040152	G00002002	G 1/2	11	37	25
8003151	8040152	G00002002		13	37	
8003200	8040201	G00002004	G 3/4	15	36	25
8003201	8040201	G00002004		19	41	
8003250	8040251	G00002006	G 1	25	41	25
8003300	8040301	G00002010	G 1¼	30	49	

Raccordo portagomma curvo 90° con battuta piana per girello
90° flat seat hosetail for fly nut.
Raccord coudé a 90° avec siège plat pour écrou.

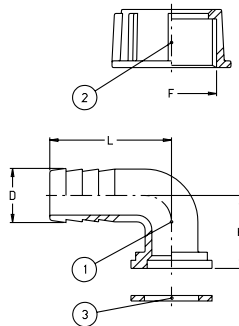

Part No. 1	Part No. 2	Part No. 3	F	D mm	H mm	L mm	Pack
8013150	8040152	G00002002	G 1/2	11	28,5	33	25
8013200	8040201	G00002004	G 3/4	13	31,5	36	25
8013201	8040202	G00002004		19	33	45	
8013250	8040251	G00002006	G 1	25	36,5	53	25
8013300	8040301	G00002010	G 1¼	30	44	60	25

Raccordo portagomma curvo 45° per girello
45° hosetail for fly nut
Raccord coudé a 45° pour écrou

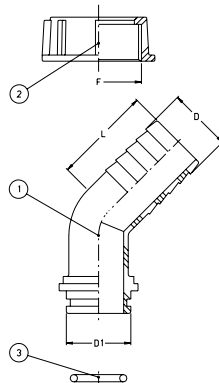

Part No. 1	Part No. 2	Part No. 3	F	D mm	D1 mm	L mm	Pack
8015300	8040301	G00001022	G 1¼	30	31,5	48	25
8015350	8040351	G00001028		30	37,5	48	
8015351	8040351	G00001028	G 1½	35	37,5	48	25
8015352	8040351	G00001028		40	37,5	51	
8015400	8040401	G00001030	G 2	40	47	60	25

Raccordo portagomma curvo 45° con filetto maschio
45° male threaded hosetail
Raccord porte-tuyau coudé a 45° filetage mâle

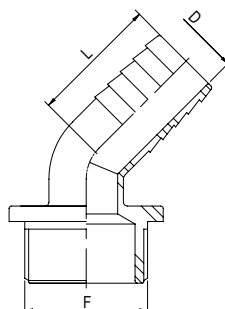

Part No.	F	D mm	L mm	Pack
8014300	G 1¼	30	55	25
8014301		35	55	
8014302		40	55	
8014350	G 1½	30	55	25
8014351		35	55	
8014352		40	60	

Raccordo portagomma diritto filetto maschio
 Hosetail male thread
 Raccord droit filetage mâle

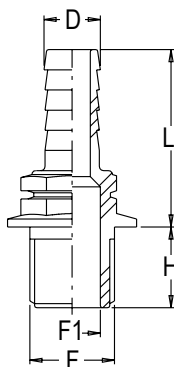

Part No.	F	F1 mm	D mm	H mm	L mm	Pack
8001101	G 3/8	10	11	20	43	25
8001151		14	13	20	44	
8001152	G 1/2	14	15	20	44	25
8001153		14	19	20	49	
8001154		14	22	20	48	
8001201		18	13	22	46	
8001202		18	15	22	46	
8001203	G 3/4	18	19	22	51	25
8001204		18	22	22	51	
8001205		18	25	22	51	
8001251		25	19	22	53	
8001252	G 1	25	25	22	53	25
8001253		25	30	22	60	
8001254		25	32	22	63	
8001301		32	25	24	55	
8001302		32	30	24	63	
8001303	G 1 1/4	32	32	24	65	25
8001304		32	35	24	69	
8001305		32	38	24	72	
8001306		32	40	24	72	
8001351		38	40	24	72	
8001352	G 1 1/2	38	45	24	75	25
8001353		38	50	24	78	
8001401	G 2	47,5	52	27	78	10
8001501	G 3	75,5	76	35	103,5	10

Raccordo portagomma curvo 90° filetto maschio
 90° hosetail - male thread
 Raccord coudé à 90° filetage mâle

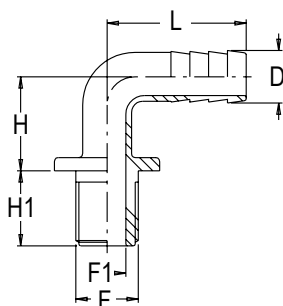

Part No.	F	F1 mm	D mm	H mm	L mm	H1 mm	Pack
8011101	G 3/8	10	13	25	37	20	25
8011102		10	15	25	37	20	
8011151		14	13	25	37	20	
8011152		14	15	25	37	20	
8011153	G 1/2	14	19	25	37	20	25
8011154		14	13	25	37	27	
8011155		14	15	25	37	27	
8011156		14	19	25	37	27	
8011201		18	15	31	45	22	
8011202	G 3/4	18	19	31	53	22	25
8011203		18	25	31	53	22	
8011251		25	25	31	53	22	
8011252	G 1	25	30	31	60	22	25
8011253		25	32	31	60	22	
8011301		32	25	32	60	24	
8011302		32	30	32	60	24	
8011303	G 1 1/4	32	32	32	60	24	25
8011305		32	35	47	85	24	
8011304		32	40	47	85	24	
8011351		38	30	47	80	24	
8011352		38	32	47	80	24	
8011353	G 1 1/2	38	35	47	80	24	25
8011354		38	38	47	80	24	
8011355		38	40	47	85	24	
8011401	G 2	47,5	50	53	90	27	10
8011402		47,5	52	53	95	27	
8011501	G 3	75,5	76	90	125	35	10

Raccordo portagomma curvo 90° filetto maschio
 90° hosetail - male thread
 Raccord coudé à 90° filetage mâle

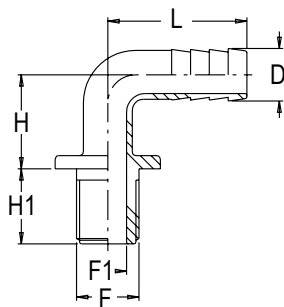

Part No.	F	B mm	D mm	H mm	L mm	H1 mm	Pack
8011339	1"¼ NPT M	24,5	32	32	60	24	25
8011340	1"¼ NPT M	30	38	47	80	24	
8011389	1"½ NPT M	30	38	47	80	24	
8011439	2" NPT M	43	52	53	95	27	

Raccordo a gomito 90° filetti femmina
 90° elbow-female threads
 Raccord coudé à 90° filetages femelle

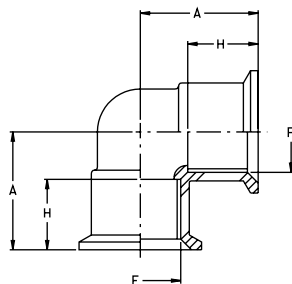

Part No.	F	H mm	A mm	Pack
8019151	G 1/2	21	33,5	25
8019201	G 3/4	23	38,5	25
8019251	G 1	23	42,5	25
8019301	G 1¼	25	50	10
8019351	G 1½	25	52,5	10
8019401	G 2	28	62,5	10

Raccordo a gomito 90° filetti maschio-femmina
 90° elbow-male and female threads
 Raccord coudé à 90° filetages mâle/femelle

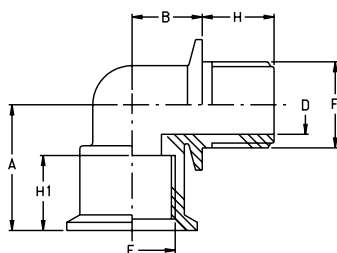

Part No.	F	D mm	H mm	H1 mm	A mm	B mm	Pack
8021151	G 1/2	14	20	21	33,5	13,5	25
8021201	G 3/4	18	22	23	38,5	21,5	25
8021251	G 1	25	22	23	42,5	24,5	25
8021301	G 1¼	32	24	25	50	30	10
8021351	G 1½	38	24	25	52,5	34	10
8021401	G 2	47,5	27	28	62,5	67	10

Raccordo a gomito 90° filetti maschio
 90° elbow-male threads
 Raccord coudé à 90° filetages mâles

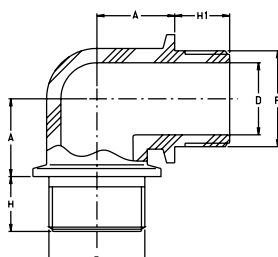

Part No.	F	H mm	H1 mm	A mm	D mm	Pack
8020251	G 1	22	22	27	25	25
8020301	G 1¼	24	24	34	32	10
8020302		24	41	34	32	
8020401	G 2	27	27	44	47,5	10

Raccordo portagomma diritto filetto femmina
 Hosetail female thread
 Raccord droit filetage femelle

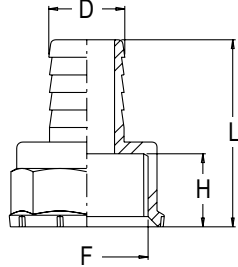

Part No.	F	D mm	H mm	L mm	Pack
8000151	G 1/2	15	21	54	25
8000152		19	25	59	
8000301		19	25	64	
8000302		22	25	64	
8000303	G 1¼	25	25	64	25
8000304		30	25	71	
8000305		32	25	74	
8000306		35	25	79	
8000307	G 1½	40	25	81	25
8000351		35	25	79	
8000352		40	25	81	
8000353		45	25	84	
8000354	G 2	50	25	87	10
8000402		50	28	90	

Raccordo portagomma curvo 90° filetto femmina
 90° hosetail female thread
 Raccord coudé a 90° femelle

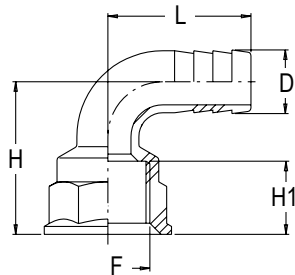

Part No.	F	D mm	H mm	L mm	H1 mm	Pack
8010201	G 3/4	19	48	45	23	25
8010202		22	48	53	23	
8010203		25	52	53	23	
8010204		30	52	60	23	
8010251	G 1	30	62	60	23	25

Kit raccordo tutto un pezzo
 Hosetail unit
 Raccord complet

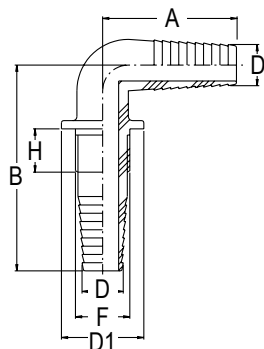

Part No.	F	H mm	D mm	D1 mm	A mm	B mm	Pack
8039151	G 1/2	20	15-17	32	45	80	25
8039201	G 3/4	21	20-24	40	65	100	25
8039251	G 1	22	26-29	44	65	100	25

Raccordo a "T" filetti femmina
Female tee
Raccord en "T" filetages femelle

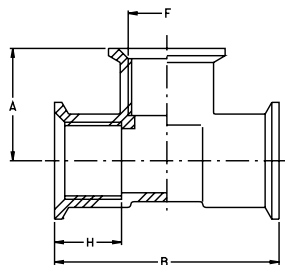

Part No.	F	H mm	B mm	A mm	Pack
8026151	G 1/2	21	67	33,5	25
8026201	G 3/4	23	77	38,5	25
8026251	G 1	23	85	42,5	10
8026301	G 1¼	25	100	50	10
8026351	G 1½	25	105	52,5	5
8026401	G 2	28	125	62,5	5
8026501	G 3	36	169	84,5	5

Raccordo a "T" filetti maschio
Male tee
Raccord en "T" filetages mâle

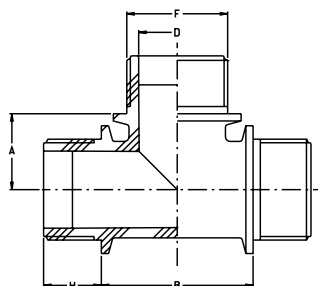

Part No.	F	H mm	B mm	A mm	D mm	Pack
8027301	G 1¼	24	111	55,5	32	10
8027351	G 1½	24	118	59	38	5
8027401	G 2	27	138	69	47,5	5

Raccordo a "T" filetti maschio - femmina
Male and female tee
Raccord en "T" filetages mâle/femelle

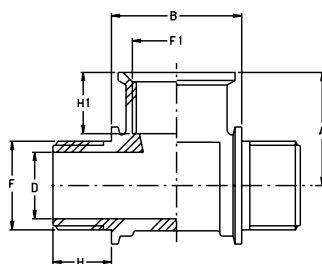

Part No.	F	F1	H mm	H1 mm	A mm	D mm	B mm	Pack
8028251	G 1	G 1	22	23	25	49	42,5	10
8028301	G 1¼	G 1 1/4	24	25	32	60	50	10
8028351	G 1½	G 1 1/2	24	25	38	64	52,5	5
8028401	G 2	G 2	27	28	47,5	76	62,5	5

Giunto filettato maschio
Male threaded connector
Joint fileté mâle

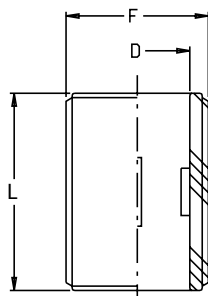

Part No.	F	D mm	L mm	Pack
8052201	G 3/4	18	46	25
8052251	G 1	25	46	25
8052301	G 1¼	32	50	25
8052351	G 1½	38	50	10
8052401	G 2	47,5	56	10

Nipplo
Nipple
Nipple

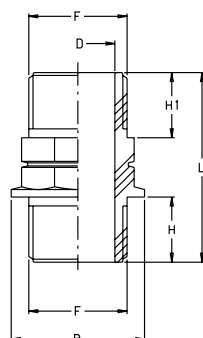

Part No.	F	B mm	H mm	D mm	L mm	H1 mm	Pack
8056151	G 1/2	32	20	14	54	20	25
8056152		32	38	14	75	20	
8056201	G 3/4	40	22	18	60	22	25
8056202		40	48	18	86	22	
8056251	G 1	45	22	25	64	22	25
8056252		45	28	25	70	22	
8056253		45	48	25	90	22	
8056301	G 1¼	54,5	24	32	68	24	25
8056302		54,5	50	32	94	24	
8056351	G 1½	62	24	38	68	24	25
8056352		62	50	38	94	24	
8056401	G 2	76	27	47,5	74	27	10
8056402		76	50	47,5	97	27	
8056451	G 2½	80	31	63	79,5	31	10
8056501	G 3	95	33,25	73,5	84,5	33,25	10

Nipplo ridotto
Reducing nipple
Nipple double réduit

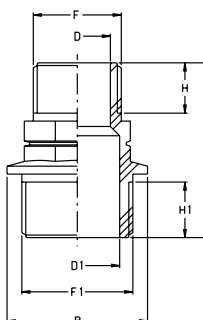

Part No.	F	B mm	H mm	D mm	F1 mm	H1 mm	D1 mm	L mm	Pack
8058101	G 3/8	24	11,5	10	G 1/2	15	14	38,5	25
8058151	G 1/2	40	20	14	G 3/4	22	18	58	25
8058152		44	20	14	G 1	22	25	60	
8058201	G 3/4	44	22	18	G 1	22	25	62	25
8058251	G 1	53	22	25	G 1¼	24	32	66	25
8058301	G 1¼	60	24	32	G 1½	24	38	68	25
8058351	G 1½	76	24	38	G 2	27	47,5	71	10
8058401	G 2	80	26	47,5	G 2½	31	63	75	10
8058451	G 2½	95	31	63	G 3	33	73,5	82	10
8058402	G 2	95	33	47,5	G 3	26	73,5	77	10

Riduzione maschio/femmina
Male and female reducer
Reducteur mâle/femelle

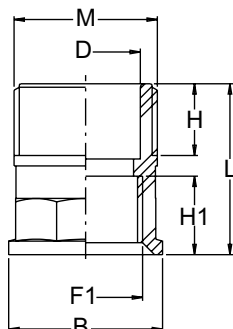

Part No.	M x F1	H mm	H1 mm	L mm	D mm	B mm	Pack
8059151	G 1/2 x G 1/2	20	21	44	14	32	25
8059202	G 3/4 x G 1/2	22	21	46	18	32	25
8059203	G 3/4 x G 1	22	23	48	18	44	25
8059204	G 3/4 x G 1¼	22	25	51	18	53	25
8059251	G 1 x G 3/4	24	16,5	45	25	36	25
8059252	G 1 x G 1	22	23	48	25	44	25
8059253	G 1 x G 1¼	22	25	51	25	53	25
8059301	G 1¼ x G 1	24	23	50	32	45	25
8059302	G 1¼ x G 1¼	24	25	53	32	53	25
8059303	G 1¼ x G 1½	24	25	53	32	60	25
8059304	G 1¼ x G 3/4	21,5	16,5	47,5	32	46	25
8059351	G 1½ x G 1¼	24	25	53	38	53	10
8059352	G 1½ x G 1	22,5	19,5	53,5	38	50	10
8059401	G 2 x G 1½	24	25	56	47,5	60	10
8059402	G 2 x G 1¼	26	22	58,5	47,5	65	10
8059403	G 2 x 3	27	36	74	47,5	106	10
8059451	G 2½ x G 1½	31	23,5	64,5	63	80	10
8059501	G 3 x 2	35	28,5	72,5	75,5	106	10
8059502	G 3 x G 2½	33	33	71,25	73,5	95	10

Manicotto ridotto
Reducing socket
Manchon réduit

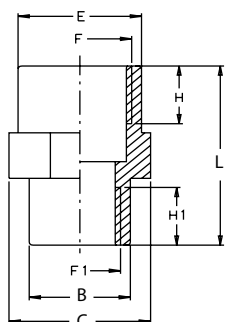

Part No.	F x F1	H mm	H1 mm	L mm	E mm	B mm	C mm	Pack
8057101	G 1/2 x G 3/8	15,5	12	33,25	28	23	36	25
8057151	G 3/4 x G 1/2	16,5	15,5	38,25	34	28	36	25
8057201	G 1 x G 3/4	19,5	16,5	43	42	34	46	25
8057251	G 1¼ x G 1	22	20	49	51	42	55	25
8057301	G 1½ x G 1¼	23,5	22	50,5	58	51	65	25
8057351	G 2 x G 1½	25	23,5	55	71,5	58	75	10

Manicotto
Socket
Manchon

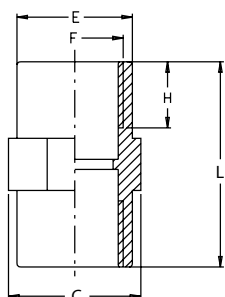

Part No.	F	H mm	L mm	E mm	C mm	Pack
8054101	G 3/8	12	30	23	30	25
8054151	G 1/2	15,5	36,5	28	30	25
8054201	G 3/4	16,5	39,5	34	36	25
8054251	G 1	20	45,5	42	46	25
8054301	G 1¼	22	51	51	55	25
8054351	G 1½	23,5	50,5	58	65	10
8054401	G 2	25	59,5	71,5	75	10

Kit bocchettone di scarico
Complete tank outlet
Kit Goulotte de vidange

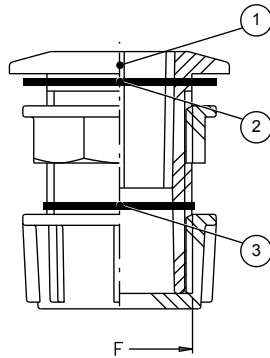

Part No.	EPDM	VITON®	EPDM	VITON®	F	Pack
	Part No. 1	Part No. 2	Part No. 3	Part No. 3		
8051151	G00002008	G00002009	G00001014	G00001015	G 1/2	25
8051201	G00002010	G00002011	G00002004	G00002005	G 3/4	25
8051251	G00002012	G00002013	G00002006	G00002007	G 1	25
8051301	G00002014	G00002015	G00002010	G00002011	G 1¼ (long)	25
8051302	G00002014	G00002015	G00002010	G00002011	G 1¼ (short)	25
8051351	G00002016	G00002017	G00002012	G00002013	G 1½	25
8051401	G00002018	G00002019	G00002014	G00002015	G 2	10

Kit bocchettone di scarico completo di guarnizioni. Bianco - atossico
Tank outlet kit with gaskets. White - non-toxic
Kit goulotte de vidange avec joint. Blanc - non toxique

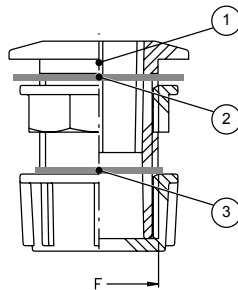

Part No.	F	Pack
1		
8359201	G 3/4	25
8359251	G 1	25
8359301	G 1¼	25
8359351	G 1½	25
8359401	G 2	20

SPARE PARTS

Part No.	Pack	Part No.	Pack
2		3	
G00002031	50	G00002034	50
G00002027	50	G00002026	50
G00002028	20	G00002031	50
G00002029	50	G00002027	50
G00002030	20	G00002028	20

Bocchettone di scarico
Tank outlet
Goulotte de vidange

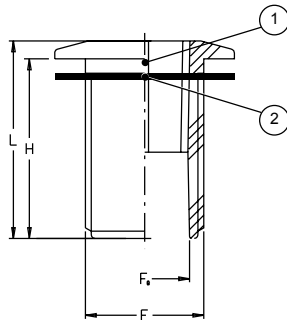

Part No.	EPDM	VITON®	F	H mm	L mm	Fo mm	Pack
	Part No. 1	Part No. 2					
8050151	G00002008	G00002009	G 1/2	43,5	47	14	25
8050201	G00002010	G00002011	G 3/4	43,5	48	18	25
8050251	G00002012	G00002013	G 1	50	55	25	25
8050301	G00002014	G00002015	G 1¼	40	46	32	25
8050302	G00002014	G00002015	G 1¼	48	54	32	25
8050351	G00002016	G00002017	G 1½	45	51	38	25
8050401	G00002018	G00002019	G 2	64	71	47,5	10

Kit aspirazione antivortice con scarico antinquinante

Kit aspirazione antivortice con scarico antinquinante di nuova concezione permette di abbinare le funzioni di aspirazione pompa e di scarico cisterna nel rispetto delle vigenti norme CE.

Antivortex suction Kit with antipollution outlet

Antivortex suction kit with antipollution outlet of new conception combining 2 functions: the suction of pump and the emptying of the tank in conformity with E.E.C. directions.

Kit aspiration anti-tourbillon avec Goulotte de vidange antipollution

Kit aspiration anti-tourbillon de nouvelle conception muni de Goulotte de vidange antipollution. Il permet de combiner les fonctions d'aspiration de la pompe et de vidange citerne conformément aux dispositions CEE en vigueur.

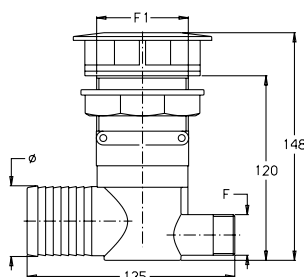

Part No.	Ø mm	F	F1	Pack
8209000	25			
8209001	30			
8209002	35	G 3/4	G 2	10
8209003	40			
8209004	45			

Girello
Fly nut
Écrou

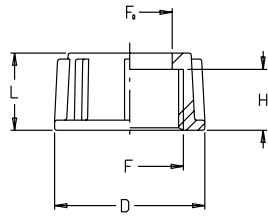

Part No.	F	D mm	H mm	L mm	Fo mm	Pack
8040101	G 3/8	26,5	14	18	13	25
8040151	G 1/2	29	15	19	12,5	25
8040152	G 1/2	29	15	19	15,5	25
8040202	G 3/4	37	15	19	21,8	25
8040251	G 1	44	18	21,5	27,3	25
8040301	G 1¼	55	18	21,5	35	25
8040351	G 1½	63	18	22	41,5	25
8040401	G 2	80	19	24	52,5	10
8040451	G 2½	92	20	24	66	10
8040501	G 3	105	25,5	30	77	10

Ghiera
Back nut
Embout

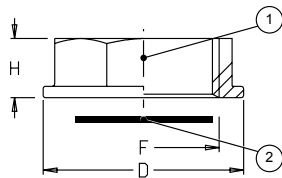

Part No. 1	EPDM	VITON®	F	D mm	H mm	Pack
	Part No. 2	Part No. 2				
8042101	G00001010	G00001011	G 3/8	26,5	13	25
8042151	G00001014	G00001015	G 1/2	29	13	25
8042201	G00002004	G00002005	G 3/4	37	13	25
8042251	G00002006	G00002007	G 1	44	13	25
8042301	G00002010	G00002011	G 1¼	55	15	25
8042351	G00002012	G00002013	G 1½	63	15	25
8042401	G00002014	G00002015	G 2	80	17	10
8042451	/	/	G 2½	105	23	10
8042501	/	/	G 3	125	26,5	10

Tappo filettato femmina
Threaded blanking cap
Bouchon fileté femelle

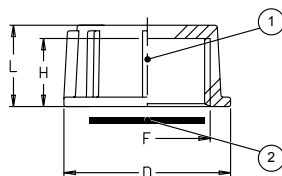

Part No. 1	EPDM	VITON®	F	D mm	H mm	L mm	Pack
	Part No. 2	Part No. 2					
8044101	G00001010	G00001011	G 3/8	26,5	14	18	25
8044151	G00001014	G00001015	G 1/2	29	15	19	25
8044201	G00002004	G00002005	G 3/4	37	15	19	25
8044251	G00002006	G00002007	G 1	44	18	21,5	25
8044301	G00002010	G00002011	G 1¼	55	18	21,5	25
8044351	G00002012	G00002013	G 1½	63	18	22	25
8044401	G00002014	G00002015	G 2	80	19	24	10
8044451	/	/	G 2½	92	20	24	10

Tappo filettato maschio
Threaded male plug
Bouchon fileté mâle

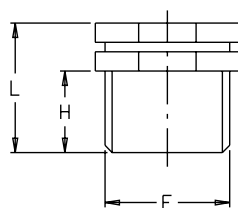

Part No.	F	H mm	L mm	Pack
8046151	G 1/2	15	23	25
8046201	G 3/4	17	27	25
8046251	G 1	19	31	25
8046301	G 1¼	22	34	25
8046351	G 1½	24	36	25
8046401	G 2	24	36	10
8046451	G 2½	31	51	10

Accoppiatori con bloccaggio a camme

I nostri accoppiatori a camme sono realizzati in polipropilene rinforzato con fibra di vetro per garantire ottima resistenza agli agenti chimici e massima durata. Leve di bloccaggio, anelli e spinotti sono in acciaio inossidabile.

Tutti i nostri accoppiatori a camme sono intercambiabili ai prodotti realizzati dai principali costruttori mondiali.

- Filettature NPT a richiesta.
- Guarnizioni di tenuta standard in NBR.

Cam lever couplings

Our comprehensive range of cam lever couplings are made from Glass reinforced polypropylene for strength and durability, featuring stainless steel arms, pins and rings.

They are interchangeable with other couplers and adapters.

- NPT threads on demand.
- NBR standard Gaskets

Raccords rapides a cammes

Tous nos raccords rapides sont fabriqués en polypropylène renforcé par fibres de verre avec parties métalliques en acier inoxydable afin de garantir une fiabilité et une durée optimale.

Tous nos raccords sont compatibles avec les produits des principaux fabricants.

- Filetage NPT sur demande.
- Joints en: NBR.



Adattatore maschio » Filetto femmina

Male adapter » Female thread
Adapteur mâle » Filet femelle

A



Part No.	Size	F	Pack
8034201	G 3/4	G 3/4	25
8034251	G 1	G 1	25
8034301	G 1¼	G 1¼	25
8034351	G 1½	G 1½	25
8034401	G 2	G 2	25
8034501	G 3	G 3	10

Accoppiatore femmina » Filetto maschio

Female coupler » Male thread
Coupleur femelle » Filet mâle

B



Part No. 1	Size	F	Pack
8034202	G 3/4	G 3/4	25
8034252	G 1	G 1	25
8034302	G 1¼	G 1¼	25
8034352	G 1½	G 1½	25
8034402	G 2	G 2	25
8034502	G 3	G 3	10

SPARE PARTS

Part No. 2	Pack
G00002063	50
G00002062	50
G00002061	50
G00002060	50
G00002059	50
G00002058	50

Accoppiatore femmina » Portagomma

Female coupler » Hosetail
Coupleur femelle » Portetuyau

C



Part No. 1	Size	Ø mm	Pack
8034203	G 3/4	19	25
8034253	G 1	25	25
8034304	G 1¼	32	25
8034354	G 1½	38	25
8034403	G 2	50	25
8034503	G 3	75	10

SPARE PARTS

Part No. 2	Pack
G00002063	50
G00002062	50
G00002061	50
G00002060	50
G00002059	50
G00002058	50

Accoppiatore femmina » Filetto femmina.
 Female coupler » Female thread
 Coupleur femelle » Filet femelle.



Part No. 1	Size	F	Pack
8034204	G 3/4	G 3/4	25
8034254	G 1	G 1	25
8034305	G 1¼	G 1¼	25
8034355	G 1½	G 1½	25
8034404	G 2	G 2	25
8034504	G 3	G 3	10

SPARE PARTS

Part No. 2	Pack
G00002063	50
G00002062	50
G00002061	50
G00002060	50
G00002059	50
G00002058	50

Adattatore maschio » Portagomma
 Male adapter » Hosetail
 Adapteur mâle » Portetuyau



Part No.	Size	Ø mm	Pack
8034205	G 3/4	19	25
8034255	G 1	25	25
8034307	G 1¼	32	25
8034357	G 1½	38	25
8034405	G 2	50	25
8034505	G 3	75	10

Adattatore maschio » Filetto maschio.
 Male adapter » Male thread
 Adapteur mâle » Filet mâle



Part No.	Size	F	Pack
8034206	G 3/4	G 3/4	25
8034256	G 1	G 1	25
8034308	G 1¼	G 1¼	25
8034358	G 1½	G 1½	25
8034406	G 2	G 2	25
8034506	G 3	G 3	10

Tappo per accoppiatore femmina
 Cap for female coupler
 Bouchon pour coupleur femelle



Part No. 1	Size	Pack	Part No. 2
8034207	G 3/4	25	G00002063
8034257	G 1	25	G00002062
8034309	G 1¼	25	G00002061
8034359	G 1½	25	G00002060
8034407	G 2	25	G00002059
8034507	G 3	10	G00002058

Tappo per adattatore maschio
 Cap for male adapter
 Bouchon adapteur mâle



Part No.	Size	Pack
8034208	G 3/4	25
8034258	G 1	25
8034310	G 1¼	25
8034360	G 1½	25
8034408	G 2	25
8034508	G 3	10

Raccordo portagomma a "T"
Tee hosetail
Raccord en "T"

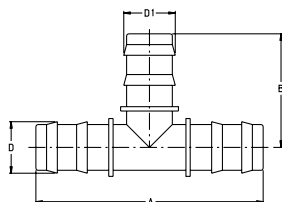

Part No.	D mm	D1 mm	A mm	B mm	Pack
8025000	16	16	68	34	100
8025001	20	20	59	44	100
8025002	25	25	106	47	100
8025003	25	32	95	56	100
8025004	32	32	130	49	100
8025005	40	40	140	68	50

Raccordo a "Y"
"Y" fitting
Raccord en "Y"

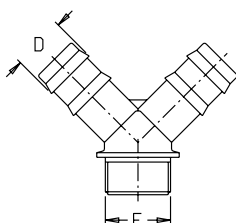

Part No.	F	D mm	Pack
8031000	G 3/4	15	25
8031001	G 3/4	25	25
8031002	G 1	25	25
8031003	G 1	30	25
8031004	G 1 1/4	30	25

Raccordo portagomma diritto di giunzione
Hosetail connector
Raccord porte-tuyau

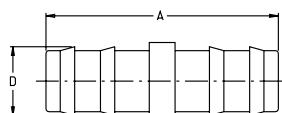

Part No.	D mm	A mm	Pack
8004000	16	59	100
8004001	20	68	100
8004002	25	73	100
8004004	32	73	100
8004003	36	87	50

Raccordo a "T" filetti maschio per raccordi a battuta piana
Male tee for flat seat fittings
Raccord en "T" filetages mâle pour raccords avec siège plat

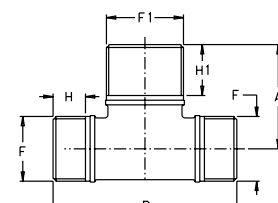

Part No.	F	F1	H mm	H1 mm	A mm	B mm	Pack
8027151	G 1/2	G 1/2	15	15	34	68	50
8027152	G 1/2	G 3/4	15	16,5	35	68	50
8027201	G 3/4	G 3/4	16,5	16,5	35	71	50
8027202	G 3/4	G 1	16,5	17	43	71	50
8027251	G 1	G 1	17	17	43	86	25
8027252	G 1	G 1 1/4	17	19,5	51	86	25

Guarnizioni O-Rings per raccorderia con filetto femmina

O-Ring gaskets for fittings with female thread
Joints toriques pour raccords filetage femelle

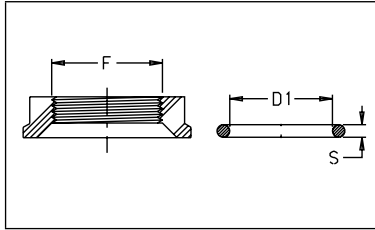

EPDM

VITON®

Part No.	Part No.	F	D1 mm	S mm	Pack
G00001018	G00001019	G 1/2	20,24	2,62	50
G00001020	G00001021	G 3/4	25,07	2,62	50
G00001026	G00001027	G 1	29,82	2,62	50
G00001046	G00001047	G 1¼	39,69	3,53	50
G00001048	G00001049	G 1½	47,22	3,53	50
G00001052	G00001053	G 2	58,74	3,53	50

Guarnizioni O-Rings per raccorderia con girello

O-Ring Gaskets for fittings with fly nut
Joints toriques pour raccords avec écrou

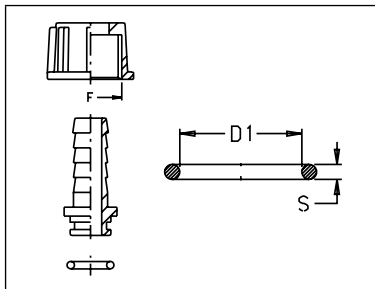

EPDM

VITON®

Part No.	Part No.	F	D1 mm	S mm	Pack
G00001002	G00001003	G 1/2	10,5	2	50
G00001012	G00001013	G 3/4	13,1	2,62	50
G00001018	G00001019	G 1	20,24	2,62	50
G00001022	G00001023	G 1¼	26,65	2,62	50
G00001028	G00001029	G 1½	31,42	2,62	50
G00001030	G00001031	G 2	39,34	2,62	50

Guarnizioni per raccorderia a sede piana con girello

Gaskets for flat seat fittings with fly nut
Joints pour raccords à siège plat avec écrou

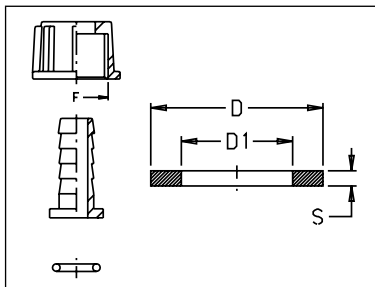

EPDM

VITON®

Part No.	Part No.	F	D mm	D1 mm	S mm	Pack
G00002000	G00002001	G 3/8	14	10	2,5	50
G00002002	G00002003	G 1/2	19,2	11,5	2,5	50
G00002004	G00002005	G 3/4	24,5	17	2,5	50
G00002006	G00002007	G 1	30,7	20	2,5	50
G00002010	G00002011	G 1¼	39,5	27,5	2,5	50

Guarnizioni per tappi con filetto femmina
Gaskets for threaded blanking cap
Joints pour bouchons filetage femelle

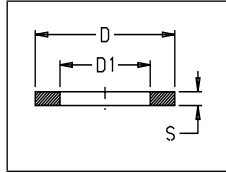
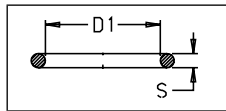
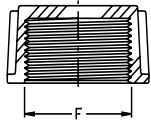

EPDM		VITON®		F	D	D1	S	Pack
Part No.	Part No.		mm	mm	mm	mm		
G00001010	G00001011	G 3/8	-	11,19	2,62	50		
G00001014	G00001015	G 1/2	-	13,95	2,62	50		
G00002004	G00002005	G 3/4	24,5	17	2,5	50		
G00002006	G00002007	G 1	30,7	20	2,5	50		
G00002010	G00002011	G 1¼	39,5	27,5	2,5	50		
G00002012	G00002013	G 1½	45	33	3	50		
G00002014	G00002015	G 2	60	40	4	50		

Guarnizioni piane per raccorderia a parete con filetto maschio
Flat Gaskets for wall fittings with male thread
Joints toriques pour raccord mural filetage mâle

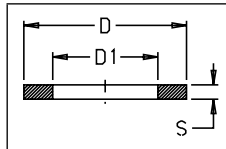
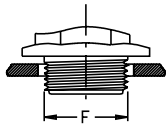

EPDM		VITON®		F	D	D1	S	Pack
Part No.	Part No.		mm	mm	mm	mm		
G00002044	/	G 1/4	20	13	3	50		
G00002004	G00002005	G 3/8	24,5	17	2,5	50		
G00002008	G00002009	G 1/2	33	21	2,5	50		
G00002010	G00002011	G 3/4	39,5	27,5	2,5	50		
G00002012	G00002013	G 1	45	33	3	50		
G00002014	G00002015	G 1¼	60	40	4	50		
G00002016	G00002017	G 1½	67	47	3	50		
G00002018	G00002019	G 2	84	59	4	50		
G00002045	/	G 2½	94,5	76	3,5	50		
G00002040	/	G 3	110	90	3,5	50		

Guarnizioni O-Rings per raccorderia con attacco a forchetta. O-Ring gaskets for fittings with fork couplings. Joints toriques pour raccords à fourche.



EPDM



VITON®

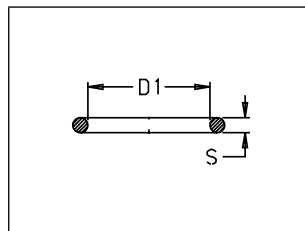

EPDM		VITON®		Type	D1	S	Pack
Part No.	Part No.		mm	mm	mm		
G00001020	G00001021	AF3	25,07	2,62	50		
G00001276	/	AF4	28,17	3,53	50		
G00001277	G00001074	AF5	36,10	3,53	50		
G00001278	/	AF6	41,28	3,53	50		
G00001050	G00001051	AF7	53,57	3,53	50		
G00001054	G00001055	AF9	82,14	3,53	50		







LEGENDA

Campo di impiego / Use / Utilisation

- | | | | | | |
|--|---|---|--|---|--|
|  | Per macchine a basso volume
<i>For low-volume spraying machines</i>
<i>Pour machines basse volum</i> |  | Per atomizzatori
<i>For orchard sprayers</i>
<i>Pour atomiseurs</i> |  | Per macchine da diserbo
<i>For crop sprayers</i>
<i>Pour pulvérisateurs</i> |
|  | Componente modulare
<i>Modular component</i>
<i>Composant modulaire</i> | | | | |



Caratteristiche / Features / Caracteristiques

- | | | | | | |
|--|---|---|---|---|--|
|  | Portata
<i>Flow rate</i>
<i>Débit</i> |  | Pressione d'esercizio
<i>Operating pressure</i>
<i>Pression de service</i> |  | Peso
<i>Weight</i>
<i>Poids</i> |
|  | Temperatura max
<i>Max temperature</i>
<i>Temperature maxi</i> |  | Tensione di alimentazione
<i>Working voltage</i>
<i>Tension d'alimentation</i> | | |

Accessori da ordinare separatamente *Accessories to be ordered separately* *Accessoires à commander séparément*

- FILTER** Cestelli per coperchi
Basket filters for tank lids
Filters à corbeille pour couvercles
- 
- RING** Anelli per coperchi
Rings for tank lids
Bagues pour couvercles
- 

FEATURES

- | | |
|---|---|
|  | Prodotti non per uso alimentare
<i>Products not for food use</i>
<i>Produits non pour un usage alimentaire</i> |
|  | Temperatura massima
<i>Max temperature</i>
<i>Temperature maxi</i> |

ARTICOLI PER IMMISSIONE LIQUIDI E DI COMPLETAMENTO 5

BASKET FILTERS, TANK LIDS AND ACCESSORIES
ARTICLES POUR L'EQUIPEMENT DES CUVES

Articoli per immissione liquidi e di completamento

Tutti gli articoli per completamento cisterne GEOLINE sono stati progettati per soddisfare le più diverse esigenze di trasporto di liquidi per uso agricolo e industriale. Sono realizzati in polipropilene, le tenute sono in EPDM (Viton® a richiesta) mentre i particolari metallici sono realizzati in acciaio inox AISI 304.

Basket filters, tank lids and accessories

All GEOLINE basket filters, tank lids and accessories are designed to meet a variety of requirements for transporting liquids for agricultural and industrial applications. They are in polypropylene, with EPDM gaskets (Viton® on demand) and AISI 304 stainless steel parts.

Articles pour l'équipement des cuves

Tous les articles pour l'équipement des cuves GEOLINE ont été étudiés pour satisfaire les exigences les plus diverses dans le transport de liquides soit d'emploi agricole qu'industriel. Ils sont tous réalisés en polypropylène, les joints sont en EPDM (Viton® sur demande) tandis que les parties métalliques sont en acier inoxydable AISI 304.



Coperchi per cisterne serie Abat

- Particolarmente indicato per cisterne di grandi capacità, dove vengono applicate pompe di caricamento ad alta portata fino a 600 l/1'.
 - La nuova valvola di sfiato garantisce un perfetto passaggio d'aria, non riscontrabile sugli altri coperchi in commercio.

Caratteristiche tecniche:

- struttura in polipropilene
- angolo di ribaltamento massimo di 180°
- tenuta garantita da una sfera galleggiante direttamente a battuta sulla guarnizione.
- angolo di svitamento 10°
- valvola di sfiato con sfera galleggiante.

Tank lids - Abat series

New hinged tank lid ABAT:

-above all suggested for big capacity tanks, on which there are applied pumps at high flow rate until 600 l/1'.
 - the new breather valve grants a perfect air passage, not finding in other tank lids on sale

Technical features:

- polypropylene structure
- max upending angle: 180°
- Seal guaranteed by a floating ball sitting directly against the gasket.
- unscrewing angle: 10°
- floating ball vent valve.

Couvercles pour cuves série Abat

- Particulièrement indiqué pour cuves de grand capacité, sur lequel on applique pompe de chargement à haute débit jusqu'à 600 l/1'.
 - La nouvelle soupape garantis un parfait passage d'air, pas vérifiable sur les autres couvercles en commerce.

Caractéristiques techniques:

- structure en polypropylène
- angle de renversement maxi. 180°
- Tenue garantie par une sphère flottante directement en butée sur le joint.
- angle de dévissage 10°
- clapet d'aspiration à bille flottante.



Part No.	ØA mm	ØC mm	B mm	D mm	BREATHER	Pack
8169014	357	320	380	120	FLOATING BALL VENT VALVE	8
8170015	457	415	480	120	FLOATING BALL VENT VALVE	8
8169015	357	320	380	120	CLOSED	8
8170016	457	415	480	120	CLOSED	8



Ordinare filtro separatamente
 Filter to be ordered separately
 Commander filtre séparément

FILTER
 Pag. 205

HIGHLIGHTS

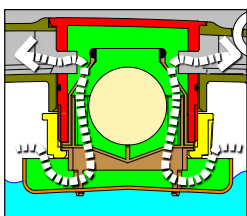

OPEN

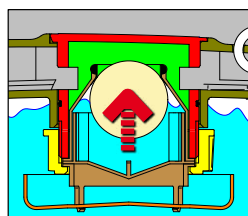

CLOSED



- Possibilità di chiusura con lucchetto (non fornito).
- Possibility to lock with padlock (not supplied).
- Possibilité de verrouillage avec cadenas (non fourni).

DIMENSIONS

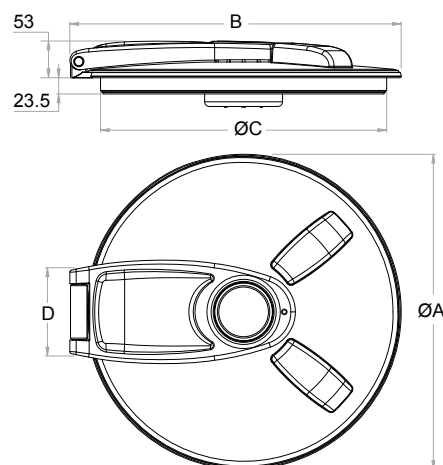

Set Coperchio + Anello.

Lid + Ring kit.

Kit Couvercle + Bague.

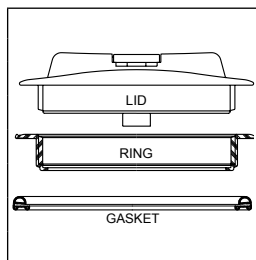

Part No.	Ø mm	LID	Configuration RING	GASKET	Pack
8149000	250	8146002	8148000	/	10
8149002	255	8146002	8148002	G00000001	10
8155001	350	8152004	8154000	/	10
8155006	350	8152004	8154002	G00000002	10
8161001	450	8158005	8160000	/	10
8161007	450	8158005	8160002	G00000003	10

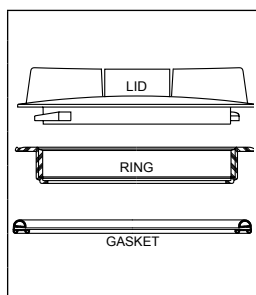

Part No.	Ø mm	LID	Configuration RING	GASKET	Pack
8155000	350	8152002	8154000	/	10
8155004	350	8152002	8154002	G00000002	10
8161000	450	8158002	8160000	/	10
8161005	450	8158002	8160002	G00000003	10
8167001	620	8164002	8166000	/	10
8167002	620	8164002	8166001	G00000044	10
8167003	620	8164000	8166001	G00000044	10

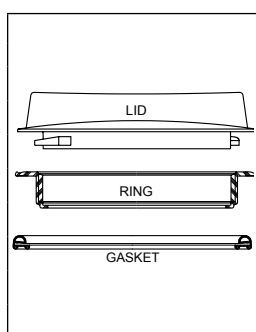

Part No.	Ø mm	LID	Configuration RING	GASKET	Pack
8143001	140	8140002	8142000	G00000000	10
8143002	140	8140003	8142000	G00000000	10
8149001	250	8146000	8148000	/	10
8155002	350	8152000	8154000	/	10
8155005	350	8152000	8154002	G00000002	10
8161002	450	8158000	8160000	/	10
8161003	450	8158000	8160002	G00000003	10
8167000	620	8164000	8166000	/	10



Ordinare filtro separatamente
Filter to be ordered separately
Commander filtre séparément

FILTER



Pag. 205

Coperchi per cisterne serie Manta con 1 sfiato a labirinto.

Tank lids Manta with 1 vent

Couvercles pour cuves série Manta avec 1 labyrinthe.

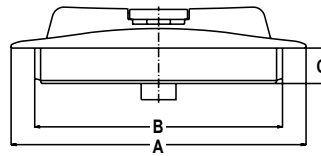

Part No.	A mm	B mm	C mm	BREATHER	Pack
8146002	250	210	31	1 LABYRINTH	10
8152004	350	313	29	1 LABYRINTH	10
8158005	450	408	23	1 LABYRINTH	10



Ordinare anello e filtro separatamente.
 Ring and filter to be ordered separately.
 Commander bauge et filtre séparément.

FILTER



Pag. 205

RING



Pag. 204

Coperchi per cisterne serie Manta con 1 sfiato a molla.

Tank lids, Manta series, with 1 spring breather.

Couvercles pour citernes série Manta avec 1 évent à ressort.

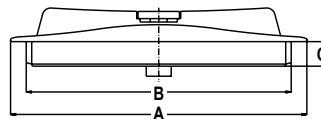

Part No.	A mm	B mm	C mm	BREATHER	Pack
8146001	250	210	31	1 SPRING VALVE	10



Ordinare anello e filtro separatamente.
 Ring and filter to be ordered separately.
 Commander bauge et filtre séparément.

FILTER



Pag. 205

RING



Pag. 204

Coperchi per cisterne serie Manta chiusi.

Closed tank lids, Manta series

Couvercles pour citernes série Manta fermés.

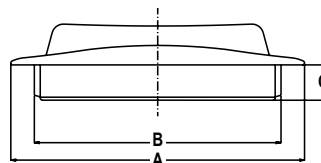

Part No.	A mm	B mm	C mm	BREATHER	Pack
8146000	250	210	31	CLOSED	10
8152000	350	313	29	CLOSED	10
8158000	450	408	23	CLOSED	10
8164000	611	599	28	CLOSED	10



Ordinare anello e filtro separatamente.
 Ring and filter to be ordered separately.
 Commander bauge et filtre séparément.

FILTER



Pag. 205

RING



Pag. 204

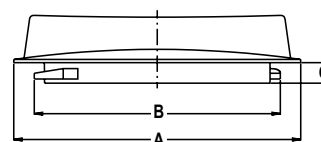

Part No.	A mm	B mm	C mm	BREATHER
8140000	140	120	8	CLOSED

Coperchi per cisterne serie Manta con 2 sfiati a labirinto.

Tank lids Manta with 2 vents.

Couvercles pour cuves série Manta avec 2 labyrinthe.

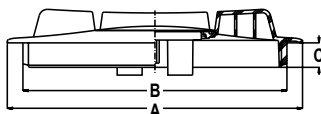

Part No.	A mm	B mm	C mm	BREATHER	Pack
8152002	350	313	29	2 LABYRINTH	10
8158002	450	408	23	2 LABYRINTH	10
8164002	611	559	26	2 LABYRINTH	10



Ordinare anello e filtro separatamente.
Ring and filter to be ordered separately.
Commander bauge et filtre séparément.

FILTER



Pag. 205

RING



Pag. 204

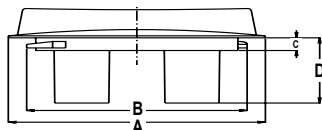

Part No.	A mm	B mm	C mm	D mm	BREATHER	Pack
8140002	140	120	8	52,5	2 LABYRINTH	10

Coperchi per cisterne serie Manta con sfiato a 4 labirinti.

Tank lids Manta with 4 vents.

Couvercles pour cuves série Manta avec 4 labyrinthe.

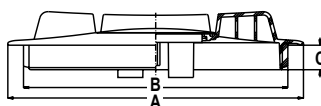

Part No.	A mm	B mm	C mm	BREATHER	Pack
8152003	350	313	29	4 LABYRINTH	10
8158003	450	408	23	4 LABYRINTH	10



Ordinare anello e filtro separatamente.
Ring and filter to be ordered separately.
Commander bauge et filtre séparément.

FILTER



Pag. 205

RING



Pag. 204

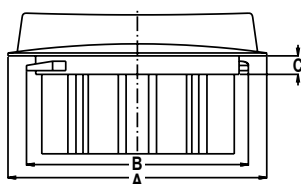

Part No.	A mm	B mm	C mm	D mm	BREATHER	Pack
8140003	140	120	8	52,5	4 LABYRINTH	10

Coperchi per cisterne serie Manta con 2 sfianti a molla.

Tank lids, Manta series, with 2 spring breather.

Couvercles pour citernes série Manta avec 2 événements à ressort.

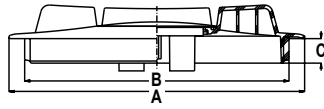

Part No.	A mm	B mm	C mm	BREATHER	Pack
8152001	350	313	29	2 SPRING VALVE	10
8158001	450	408	23	2 SPRING VALVE	10



Ordinare anello e filtro separatamente.
 Ring and filter to be ordered separately.
 Commander bague et filtre séparément.

FILTER



Pag. 205

RING



Pag. 204

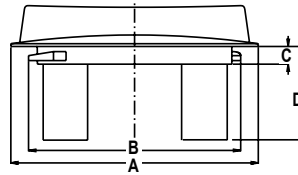

Part No.	A mm	B mm	C mm	D mm	BREATHER	Pack
8140001	140	120	8	52,5	2 SPRING VALVE	10

RINGS

Anelli per coperchi serie Manta.

Rings for tank lids (Manta series).

Bagues pour couvercles série Manta.

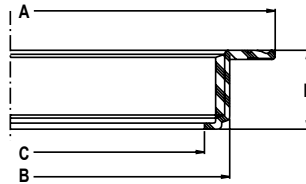

Part No.	A mm	B mm	C mm	L mm	FIXING	Pack
8148000	262	217	192	39	FLAT SURFACES	10
8154000	357	320	290	38		
8160000	457	415	382	35		
8166000	617	567	536	40,5		

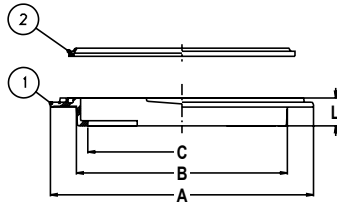

Part No. 1	Part No. 2	A mm	B mm	C mm	L mm	FIXING	Pack
8142000	G00000000	154	125	112	17	FLAT SURFACES	10

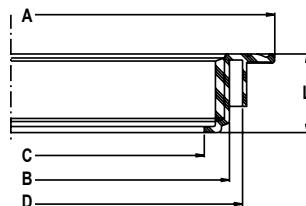

Part No.	A mm	B mm	C mm	L mm	D mm	FIXING	Pack
8148001	262	217	192	39	230	SIDE CONNECTION	10
8154001	357	320	290	38	335		
8160001	457	415	382	35	430		

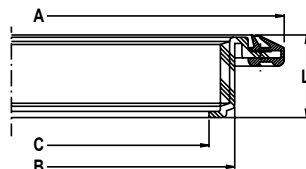

Part No.	A mm	B mm	C mm	L mm	GASKET	FIXING	Pack
8148002	265	217	192	39	G00000001	FLAT SURFACES c/w GASKET	10
8154002	368	320	290	38	G00000002		
8160002	463	415	382	35	G00000003		
8166001	612	567	536	35	G00000044		

FILTERS

Cestelli per coperchi serie Manta e Abat (18 Mesh).

Basket filters for tank lids Manta and Abat series (18 Mesh).

Filtres à corbeille pour couvercles série Manta et Abat (18 Mesh).

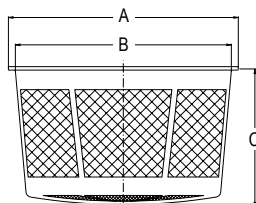

Part No.	A mm	B mm	C mm	Pack	SUITABLE FOR RINGS	SUITABLE FOR TANK LIDS
8147000	201	189	50			
8147001	201	189	120	25	8148xxx	
8147002	201	189	240			
8153000	301	287	60			
8153001	301	287	240	25	8154xxx	8169xxx
8159000	400	380	180	20		
8159001	400	380	280	20	8160xxx	8170xxx
8159002	400	380	320	15		

Cestelli in acciaio Inox per coperchi serie Manta.

Stainless Steel basket filters for Manta series tank lids.

Cuves en acier inoxydable pour couvercles série Manta.

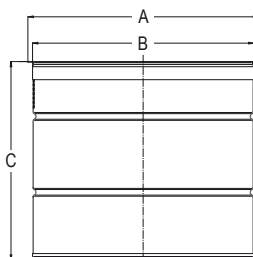

INOX

Part No.	A mm	B mm	C mm	Pack	SUITABLE FOR RINGS	SUITABLE FOR TANK LIDS
8159008	395	379	340	1	8160xxx	8170xxx

GASKETS

Guarnizioni esterne per anelli.

External gasket for rings.

Joints extérieures pour bagues.

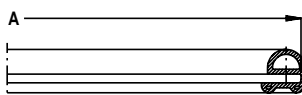

Part No.	RINGS	A mm	Pack
G0000001	8148002	255	10
G0000002	8154002	350	10
G0000003	8160002	460	10
G0000004	8166001	612	10

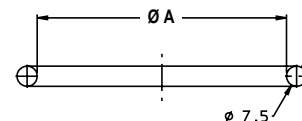

Part No.	RINGS	TANK LIDS	A mm	Pack
G0000006	8154000	8169xxx	285	10
G0000007	8160000	8170xxx	370	10
G0000010	8142000		105	10
G0000011	8148000		190	10
G0000028	8166000		505	10

Coperchio filettato femmina per serbatoi.
 Standard in colore nero

Female threaded tank lids.
 Standard black color.

Couvercle filetage femelle pour citernes.
 Standard en couleur noire.

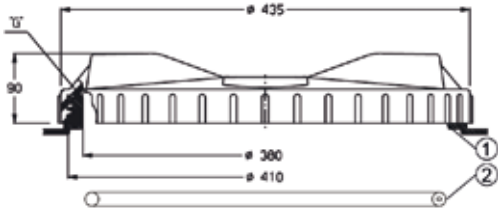

Part No. 1	Part No. 2	BREATHER	Pack
8178002	G00000007	CLOSED	10

OPTIONALS

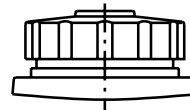

Part No.		Pack
8367000	VALVE	10

Coperchio filettato femmina chiuso senza
 guarnizione di serie.

Closed female threaded cover. It does not feature
 a gasket.

Couvercle fileté femelle fermé sans garniture de
 série.

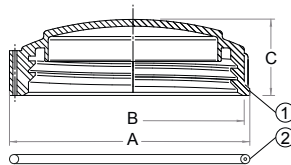

Part No. 1	Part No. 2	TYPE	A mm	B mm	C mm	Pack
8178000	G00001066	○	172	6"	56	10

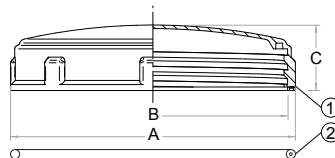

Part No. 1	Part No. 2	TYPE	A mm	B mm	C mm	Pack
8178011	G00000012	□	122	113	31	10
8178004	G00001075	○	240	226	55	10

Coperchio filettato femmina con sfiato a molla
 senza guarnizione di serie.

Female threaded cover with breather spring. It
 does not feature a gasket.

Couvercle fileté femelle avec évent à ressort sans
 garniture de série.

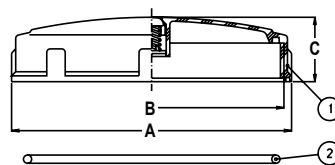

Part No. 1	Part No. 2	TYPE	A mm	B mm	C mm	Pack
8178012	G00000012	□	122	113	31	10
8178001	G00001066	○	172	6"	56	10
8178006	G00001075	○	240	226	55	10

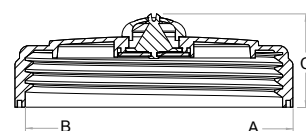

Part No.	A mm	B mm	C mm	BREATHER	Pack
8178019	122	113	41	DIAPHRAGM	10

Coperchio filettato femmina da completare con valvola di sfiato in EPDM e guarnizione fornita a parte.

Female threaded cover to be completed with breather valve in EPDM and gasket supplied separately.

Couvercle fileté femelle à compléter avec évent clapet en EPDM et garniture fournis séparément.

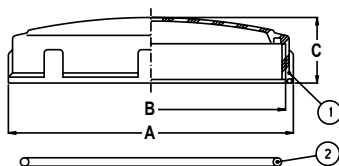

Part No. 1	Part No. 2	TYPE	A mm	B mm	C mm	Pack
8178005	G00001075	○	240	226	55	10

Valvola in EPDM.

EPDM air valve.

Clapet en EPDM.

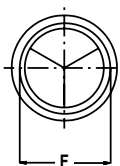

Part No.	F mm	Pack
V00101000	33	25
V00101002	33	25

Coperchio filettato femmina, con sfiato a molla, con guarnizione di serie.

Female threaded cover with breather spring and gasket.

Couvercle fileté femelle avec évent à ressort et garniture de série.

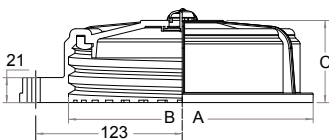
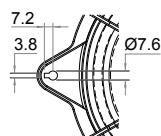

Part No.	A mm	B mm	C mm	BREATHER	Pack
8178018	220	180	69	DIAPHRAGM	10

SPARE PARTS

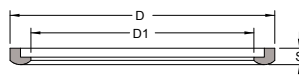

Part No.	D mm	D1 mm	S mm	Pack
G00000048	178	150	6	10

Coperchio filettato chiuso. Con guarnizione di serie.

Closed threaded cover. Gasket included.

Couvercle fileté fermé. Avec garniture de série.

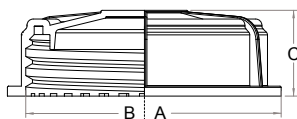

Part No.	A mm	B mm	C mm	Pack
8178016	220	180	69	10

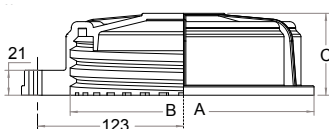
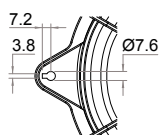

Part No.	A mm	B mm	C mm	Pack
8178017	220	180	69	10

SPARE PARTS

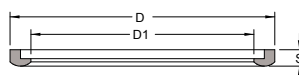

Part No.	D mm	D1 mm	S mm	Pack
G00000048	178	150	6	10

Coperchio filettato chiuso.
 Senza guarnizione di serie.

Closed threaded cover.
 It does not feature a gasket.

Couvercle fileté fermé.
 Sans garniture de série.

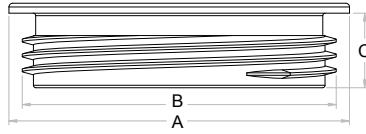

Part No.	A mm	B mm	C mm	Pack
8180000	137	126	30	10

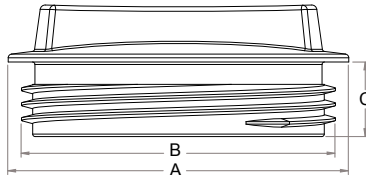

Part No.	A mm	B mm	C mm	Pack
8180001	137	126	30	10



Per completare, ordinare la guarnizione.
 To complete, please order the gasket.
 Joint à commander pour compléter.

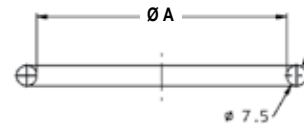

Part No.	A mm	Pack
G00000046	112	10

Coperchio filettato chiuso.
 Senza guarnizione di serie.

Closed threaded cover. It does not feature a gasket.

Couvercle fileté fermé. Sans garniture de série.

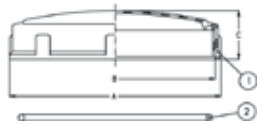

Part No. 1	A mm	B mm	C mm	Pack
8178015	122	113	31	10
8178014 gasket included	122	113	31	10



Per completare, ordinare la guarnizione.
 To complete, please order the gasket.
 Joint à commander pour compléter.

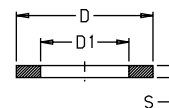

Part No. 2	D mm	D1 mm	S mm	Pack
G00000012	106	89	5	10

Coperchi per serbatoi lavamani con disco di sfiato
 antisbattimento

Caps for handwash tanks with anti-rattling exhaust
 disk

Bouchons avec évent pour réservoirs lave-mains

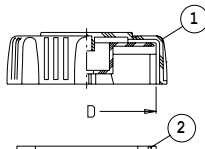

Part No. 1	Part No. 2	TYPE	D mm	BREATHER	Pack
8178007	G00002036	<input type="checkbox"/>	60	LABYRYNTH	10
8178008	G00002037	<input type="checkbox"/>	80	LABYRYNTH	10

Valvola di ritegno, filetti Maschio e Femmina.

Non-return valve, Male and Female threaded.

Vanne anti-retour, filetage male et femelle.

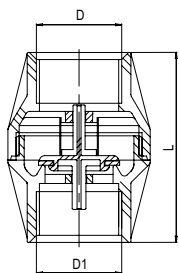

Part No.	D BSP	D1 BSP	MAX		Pack
			bar	L mm	
8206000	G 1¼ F	G 1¼ F	6	94	10
8206001	G 1½ F	G 1½ F	6	94	
8206006	G 1½ F	G 1¼ F	6	96	
8206004	G 2 F	G 2 F	4	96	

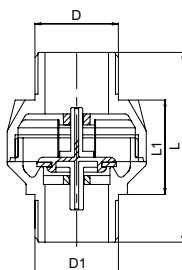

Part No.	D BSP	D1 BSP	MAX		Pack
			bar	L mm	
8206002	G 1¼ M	G 1¼ M	6	94	10
8206003	G 1½ M	G 1½ M	6		
8206005	G 2 M	G 2 M	4		

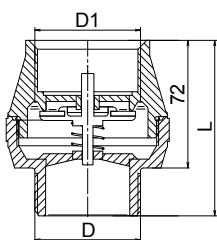

Part No.	D BSP	D1 BSP	MAX		Pack
			bar	L mm	
8206007	G 2 M	G 2 F	4	99	10

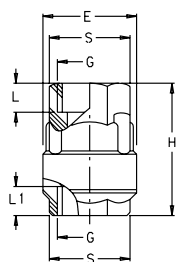

Part No.	G	MAX					bar	Pack
		E mm	H mm	L mm	L1 mm	S mm		
8369000	G 1/2	40	62	16	16	27	10	20
8369001	G 3/4	47	68	17	17	34	10	20
8369002	G 1	57	75	17	18	41	10	20

Testa rotante lavaserbatoi.

Viene azionata dal fluido, garantendo un lavaggio effettivo a 360°.
 Per un corretto fissaggio si consiglia di utilizzare il kit K00107002.

Rotational spray head

This tank rinsing nozzle has a fluid-driven rotational spray head which provides 360° coverage inside the surface of the tank.
 For an accurate coupling, the use of the KIT Ref. K00107002 is highly recommended.

Tête rotative

Cette buse de rinçage de cuve est dotée d'une tête rotative actionnée par la pression du liquide qui donne une couverture à 360° en assurant un rinçage efficace des cuves du pulvérisateur.
 Pour un bon montage, il est recommandé d'utiliser le KIT Réf. K00107002.

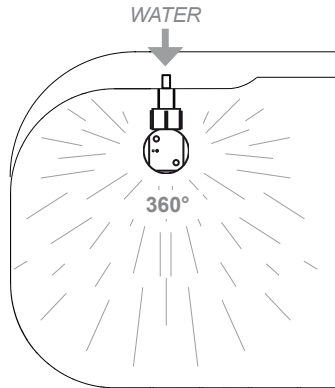
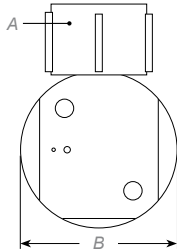

FEATURES

bar	1/1"
2	14
3	18
4	22

Part No.	Angle	A	B mm	bar	Pack
8185007	360°	G1	64	4	5

OPTIONALS





Part No.	Ø	Pack
K00107002	G1	5

Lavaserbatoi rotante.

Tank rinsing head.

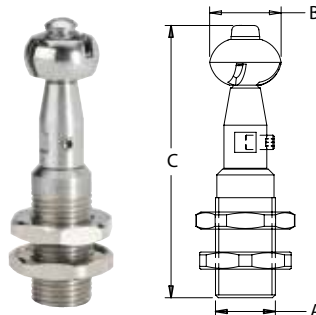
Tête de lavage rotative.



TYPE	FEATURES								
 240°	<table border="1"> <thead> <tr> <th>bar</th> <th>1/1"</th> </tr> </thead> <tbody> <tr> <td>5</td> <td>13,5</td> </tr> <tr> <td>7,5</td> <td>15,5</td> </tr> <tr> <td>10</td> <td>18</td> </tr> </tbody> </table>	bar	1/1"	5	13,5	7,5	15,5	10	18
bar	1/1"								
5	13,5								
7,5	15,5								
10	18								

Part No.	Angle	A	B mm	C mm	bar	Pack
8185005	240°	G 1/4 M	25	60	10	5
8185003	360°	G 1/4 M	25	60	10	

Part No.	Angle	A	B mm	C mm	bar	Pack
8185000	240°	G 1/2 M	25	95	10	5
8185006	360°	G 1/2 M	25	95	10	

 360°	<table border="1"> <thead> <tr> <th>bar</th> <th>1/1"</th> </tr> </thead> <tbody> <tr> <td>5</td> <td>24</td> </tr> <tr> <td>7,5</td> <td>29</td> </tr> <tr> <td>10</td> <td>34</td> </tr> </tbody> </table>	bar	1/1"	5	24	7,5	29	10	34
bar	1/1"								
5	24								
7,5	29								
10	34								

Valvola per lava barattolo

Rinsing head valve

Vanne pour tête de lavage

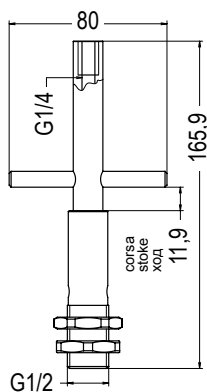

ASSEMBLY

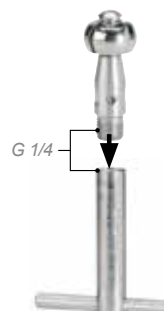

Part No.	bar	Pack
8185004	10	5

Miscelatore idraulico per polveri in polipropilene o inox.

S/S or polypropilene hydraulic powered mixer.

Mélangeur hydraulique pour poudres en acier inox ou polypropylène.

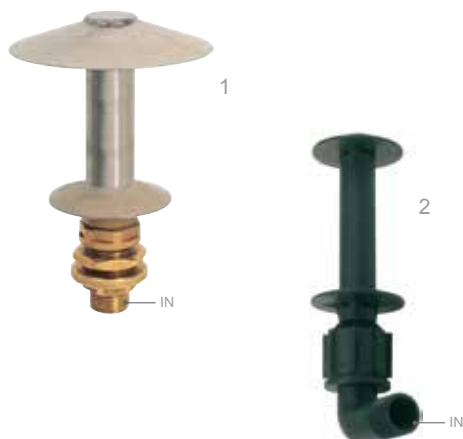

Part No.	Material	IN	Pack
1 8199001	INOX	G 1/2 M	10

Part No.	Material	IN	Pack
2 8199000	PP	G 1/2 M	10

ASSEMBLY

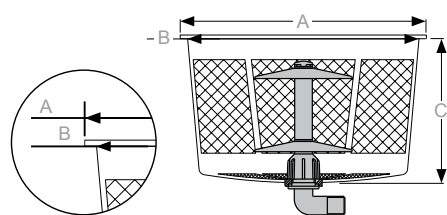

Installare utilizzando i seguenti cestelli
For fitting use the following basket filters
Installer en utilisant les suivantes filtres à corbeille



Part No.	A mm	B mm	C mm
8153001	Ø 301	Ø 287	240
8159000	Ø 400	Ø 380	180
8159001	Ø 400	Ø 380	280
8159002	Ø 400	Ø 380	320

Valvola di scarico dall'alto da 3".
Molla in acciaio inox.

Cable drain valve 3".
S/S spring.

Vanne de vidance à câble.
Ressort en acier inox.



Fino ad esaurimento
Selling out
Jusqu'à épuisement

Part No.	Pack
8203000	5

ASSEMBLY



Agitatore idraulico ispezionabile.

Easy-to-check swivel hydraulic stirrer.

Agitateur hydraulique orientable de facile inspection.



Part No.	NOZZLES mm	MATERIAL	IN	Pack
8201017	Ø 2	INOX	G 1/2"	5

Part No.	NOZZLES mm	MATERIAL	IN	Pack
8201018	Ø 2	INOX	G 1/2"	5
8201019	Ø 1,25	INOX	G 1/2"	

Linea continua: portata totale. Linea tratteggiata: portata dell'ugello.
 Unbroken line: total flow rate. Dashed line: nozzle flow rate.
 Ligne continue: débit total. Ligne en tirets: débit de buse

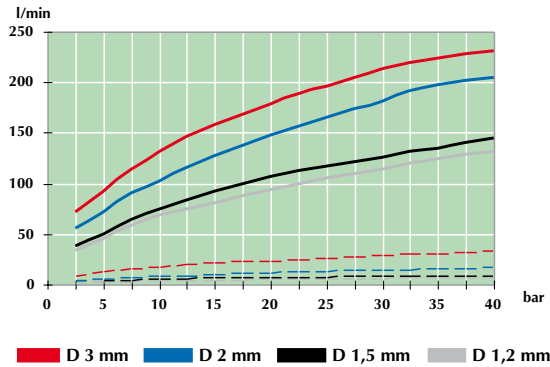

Agitatore idraulico ispezionabile.

Easy-to-check swivel hydraulic stirrer.

Agitateur hydraulique orientable de facile inspection.



Part No.	NOZZLES mm	MATERIAL	IN	FLY NUT	Pack
8201000	Ø 1,2	CERAMIC	G 1/2"	G 1" 1/4	5
8201001	Ø 1,5	CERAMIC	G 1/2"	G 1" 1/4	
8201002	Ø 2	CERAMIC	G 1/2"	G 1" 1/4	
8201003	Ø 3	CERAMIC	G 1/2"	G 1" 1/4	

Part No.	NOZZLES mm	MATERIAL	IN	FLY NUT	Pack
8201004	Ø 1,2	CERAMIC	G 1/2"	G 1" 1/4	5
8201005	Ø 1,5	CERAMIC	G 1/2"	G 1" 1/4	
8201006	Ø 2	CERAMIC	G 1/2"	G 1" 1/4	
8201007	Ø 3	CERAMIC	G 1/2"	G 1" 1/4	

Linea continua: portata totale. Linea tratteggiata: portata dell'ugello.
 Unbroken line: total flow rate. Dashed line: nozzle flow rate.
 Ligne continue: débit total. Ligne en tirets: débit de buse

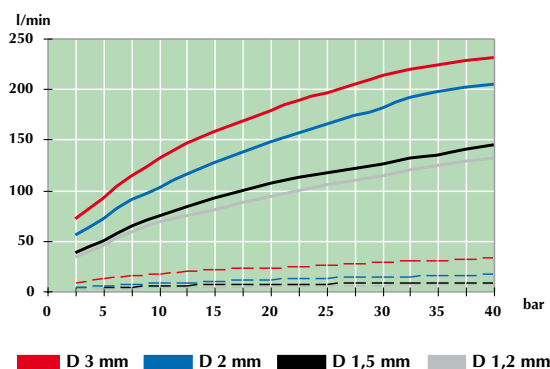

Agitatore idraulico orientabile.

Swivel hydraulic stirrer.

Agitateur hydraulique orientable.

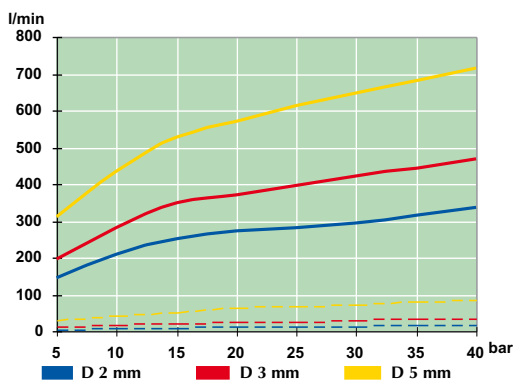

Linea continua: portata totale. Linea tratteggiata: portata dell'ugello.
 Unbroken line: total flow rate. Dashed line: nozzle flow rate.
 Ligne continue: débit total. Ligne en tirets: débit de buse

Part No.	NOZZLES mm	MATERIAL	Pack
8201010	Ø 2	CERAMIC	3
8201011	Ø 3	CERAMIC	
8201012	Ø 5	INOX	

DIMENSIONS

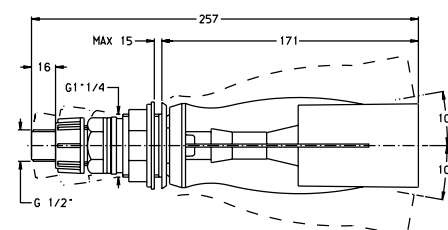

Agitatore idraulico in ottone completo di filtro
 - ingresso G 1/2"
 - foro parete ø 22 mm

Brass hydraulic stirrer
 - BSP1/2" inlet
 - wall hole ø 22 mm

Agitateur hydraulique en laiton
 - entrée 1/2" Gaz
 - trou mural ø 22 mm



Part No.	NOZZLE mm	Pack
8201013	Ø 1,2	20
8201014	Ø 1,5	
8201015	Ø 2	
8201016	Ø 3	

DIMENSIONS

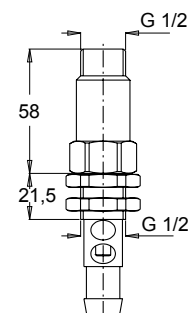

Idroiettoire orientabile (senza raccordo di aspirazione).

Swivel ejector (without a suction fitting).

Hydro-éjecteur orientable (sans raccord d'aspiration).



Part No.	NOZZLES mm	bar	Pack
8197007	Ø 3	10+35	10
8197008	Ø 5		

DIMENSIONS



Grafico ottenuto con una prevalenza di 2 m e tubo di aspirazione Ø 30 mm.
 Linea continua: portata totale. Linea tratteggiata: portata dell'ugello.

Test conditions: 2 mt head and Ø 30 mm suction pipe.
 Unbroken line: total flow rate. Dashed line: nozzle flow rate.

Conditions d'essai: hauteur d'élevation de 2 mt et tuyau d'aspiration Ø 30 mm.
 Ligne continue: débit total. Ligne en tirets: débit de buse.

Raccordo di aspirazione: da ordinare separatamente
 Suction fitting: to be ordered separately
 Raccord d'aspiration: à commander séparément

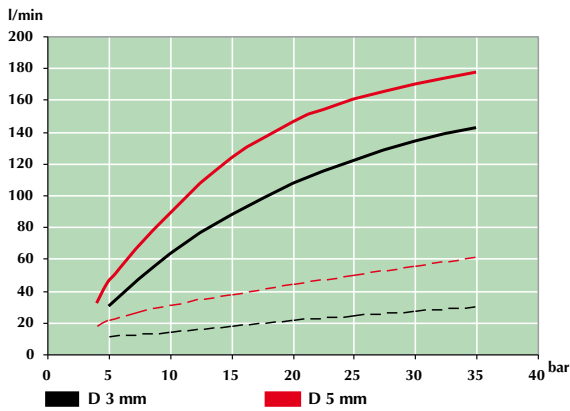
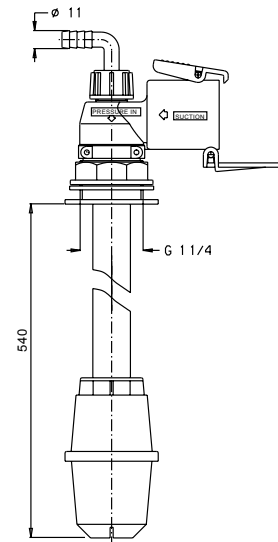
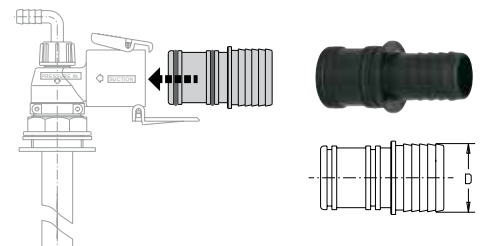

Part No.	D mm	Pack
K00002000	25	10
K00002001	30	10
K00002002	35	10
K00002003	40	10

Antivortice

Antivortex

Anti-tourbillon

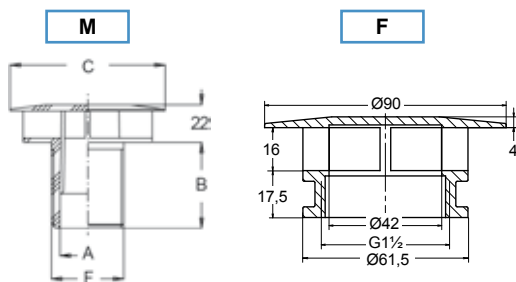

Part No.	F	A mm	B mm	C mm	Pack
8209005	G1½ M	32	50	90	
8209006	G1½ M	38	50	90	
8209007	G1½ F	42	17,5	90	25
8209008	G2 M	56	60	118	
8209009	G1 M	25	50	90	

Valvola di sfiato a labirinto.

Labyrinth breather valve.

Soupape avec labyrinthe.



Part No.	F	BREATHER	Pack
8208000	G1 M	COMPLETE	50
8208001	G1 M	WITHOUT NUT	

Protezione foglie per gruppi ventola montati su atomizzatori con viti per il fissaggio.

Leaf protection for atomizers with fixing screws.

Accessoir anti-feuilles pour les pulvérisateurs avec vis de montage.



Part No.	Pack
8316002	5

Caricabotte inox

Stainless steel ejector

Ejecteur en acier inox

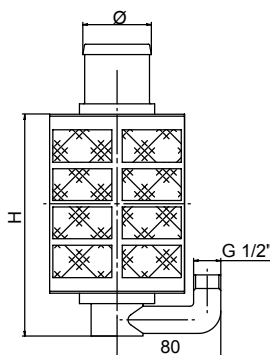

Part No.	Ø mm	H mm	Screen MESH	Pack
8197005	30	173	50	
8197006	40	173	50	6
8197011	50	173	50	

Flangia per atomizzatori in ottone con guarnizione in EPDM.

Brass sprayer flange with EPDM joint.

Bride en laiton pour atomiseur avec joint en EPDM.

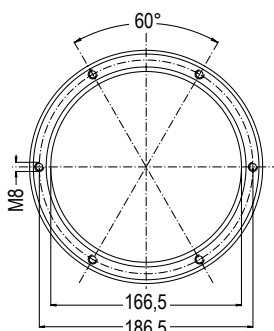

Part No.	Pack
8195000	10

Rubinetti per serbatoi lavamani

Taps for handwash tanks

Robinets pour réservoirs lave-mains

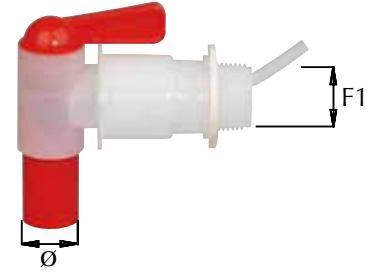
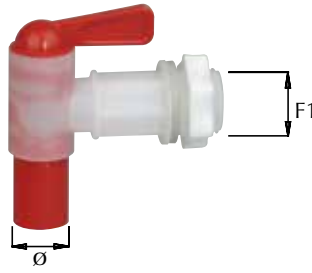

MAX

Part No.	F1	Ø mm	bar	Pack
8365000	3/4"	8	0,5	50

MAX

Part No.	F1	Ø mm	bar	Pack
8365001	3/4"	18	0,5	50

MAX

Part No.	F1	Ø mm	bar	Pack
8365002	3/4"	18	0,5	50

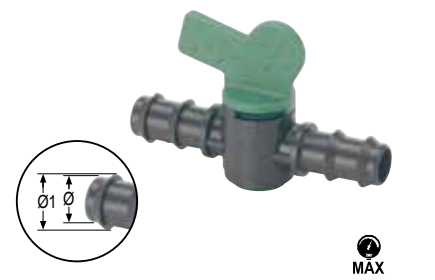
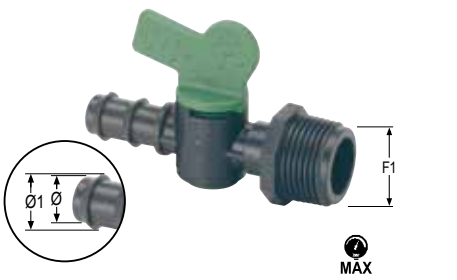

MAX

Part No.	F1	Ø mm	Ø1 mm	bar	Pack
8365003	1/2"	13	16	5	50
8365004	1/2"	16	19	5	
8365005	3/4"	13	16	5	
8365006	3/4"	16	19	5	

MAX

Part No.	F1	bar	Pack
8365007	1/2" x 1/2"	5	50
8365008	3/4" x 3/4"	5	

MAX

Part No.	Ø mm	Ø1 mm	bar	Pack
8365009	10 - 10	11	5	50
8365010	13 - 13	16	5	
8365011	16 - 16	19	5	

Raccordo a tre vie per miscelatore.

Mixer 3-way fitting.

Junction à 3 voies pour mélangeur.



MAX

Part No.	D mm	l/1'	bar	Pack
8199006	5	20÷50	2÷15	5
8199007	7	50÷100	4÷15	
8199008	9	100÷150	7÷15	
8199009	12	150÷250	4÷15	

DIMENSION

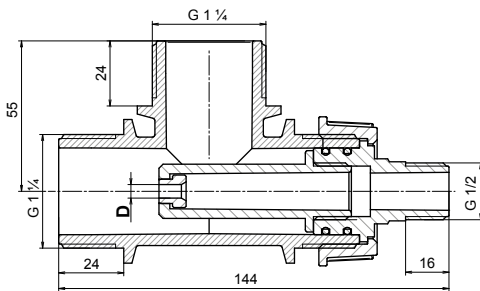

ASSEMBLY

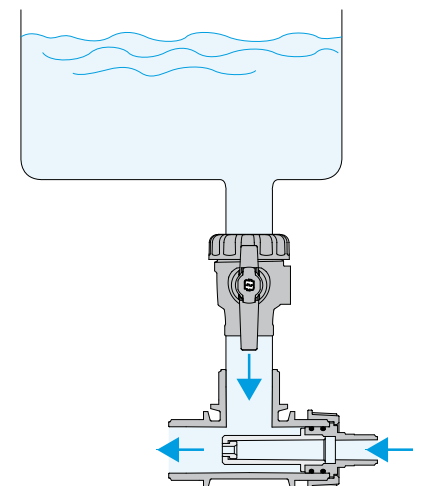

GeoDry



Il misuratore di livello meccanico **GeoDry** permette una facile e precisa lettura del livello durante la guida.

Grazie al sistema di rinvio a carrucola, la condizione di cisterna vuota (riserva) viene mostrata nella parte superiore della scala graduata, per una facile ed immediata lettura.

Costruito in acciaio inox e propilene, **GeoDry** è particolarmente indicato anche per impieghi con liquidi fortemente aggressivi e densi.

Dotato di scala di lettura "neutra", da personalizzare in funzione della capacità del serbatoio su cui viene installato, è adatto per cisterne profonde fino a 3 metri.

Viene fornito parzialmente assemblato e dotato di kit per l'installazione.

*The mechanical level indicator **GeoDry** allows an easy and precise reading of the level while driving.*

Thanks to the counter pulley system, the condition of empty tank is shown in the upper part of the scale, for easy and immediate reading.

*Built in stainless steel and polypropylene, **GeoDry** is extremely suitable for applications with dense and highly corrosive liquids.*

Equipped with a "neutral" reading scale, to customize according to the capacity of the tank on which is installed, it is suitable for tanks up to 3 meters deep.

Comes partially assembled and fitted with a kit for the installation.

*L'indicatore de niveau mécanique **GeoDry** permet une lecture facile et précise du niveau, même en conduisant.*

Grace au système de renvoi par poulie, la condition de la cuve vide est indiquée dans la partie supérieure de l'échelle, pour une lecture facile et immédiate.

*Construit en acier inoxydable et polypropylène, **GeoDry** est parfaitement adapté pour des applications avec liquides hautement corrosifs et denses.*

Equipé d'une échelle de lecture "neutre", à personnaliser en fonction de la capacité du réservoir sur lequel est installé, convient pour les réservoirs jusqu'à 3 mètres de profondeur.

Vient partiellement assemblé, et muni d'un kit pour la mise en place.

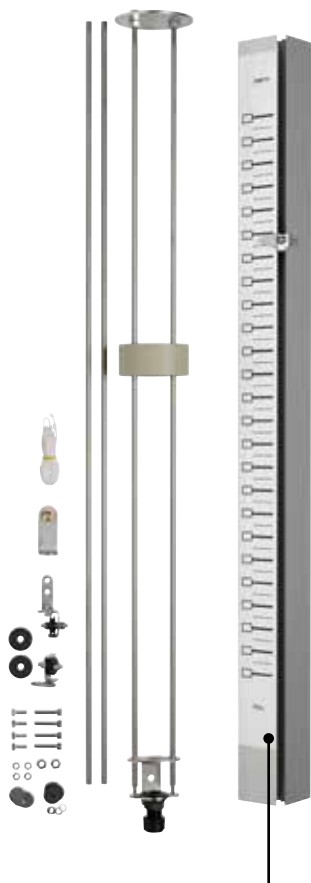

Scala graduata personalizzabile, con zona RISERVA nella parte superiore

Personalized scale, with RESERVE area on the top

Échelle personnalisée, avec zone de RÉSERVE dans la partie supérieure

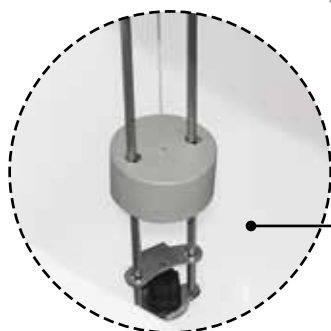

interno cisterna
internal part of the tank
intérieur du réservoir



Part No.	mm	Pack
8212009	2000	1
8212010	3000	1

Campo di impiego Use / Utilisation



KIT

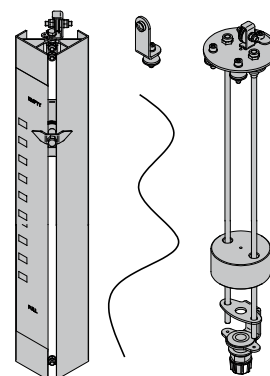

INSTALLATION

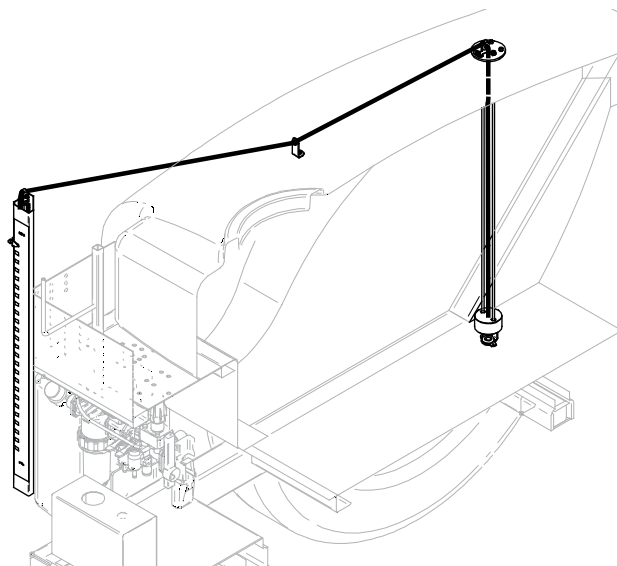

GeoDry



Il misuratore di livello meccanico **GeoDry** permette una facile e precisa lettura del livello durante la guida.

Grazie al sistema di rinvio a carrucola, la condizione di cisterna vuota (riserva) viene mostrata nella parte superiore della scala graduata, per una facile ed immediata lettura.

Costruito in acciaio inox e propilene, **GeoDry** è particolarmente indicato anche per impieghi con liquidi fortemente aggressivi e densi.

Dotato di scala di lettura "neutra", da personalizzare in funzione della capacità del serbatoio su cui viene installato, è adatto per cisterne profonde fino a 1,5 metri.

Viene fornito parzialmente assemblato e dotato di kit per l'installazione.

*The mechanical level indicator **GeoDry** allows an easy and precise reading of the level while driving.*

Thanks to the counter pulley system, the condition of empty tank is shown in the upper part of the scale, for easy and immediate reading.

*Built in stainless steel and polypropylene, **GeoDry** is extremely suitable for applications with dense and highly corrosive liquids.*

Equipped with a "neutral" reading scale, to customize according to the capacity of the tank on which is installed, it is suitable for tanks up to 1,5 meters deep.

Comes partially assembled and fitted with a kit for the installation.

*L'indicatore di livello meccanico **GeoDry** permet une lecture facile et précise du niveau, même en conduisant.*

Grace au système de renvoi par poulie, la condition de la cuve vide est indiquée dans la partie supérieure de l'échelle, pour une lecture facile et immédiate.

*Construit en acier inoxydable et polypropylène, **GeoDry** est parfaitement adapté pour des applications avec liquides hautement corrosifs et denses.*

Équipé d'une échelle de lecture "neutre", à personnaliser en fonction de la capacité du réservoir sur lequel est installé, convient pour les réservoirs jusqu'à 1,5 mètres de profondeur.

Vient partiellement assemblé, et muni d'un kit pour la mise en place.

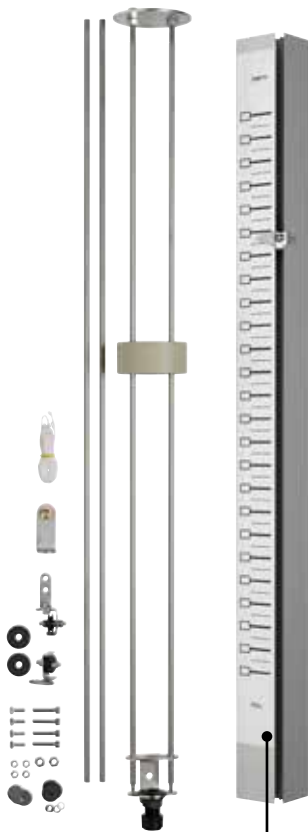

Scala graduata personalizzabile, con zona RISERVA nella parte superiore

Personalized scale, with RESERVE area on the top

Échelle personnalisée, avec zone de RÉSERVE dans la partie supérieure

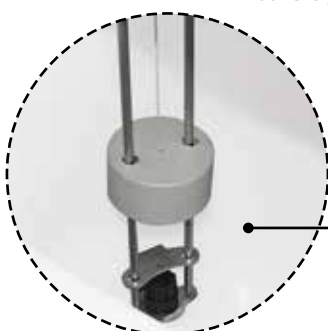

interno cisterna
internal part of the tank
intérieur du réservoir



Part No.	mm	Pack
8212011	1500	1

Campo di impiego Use / Utilisation



KIT

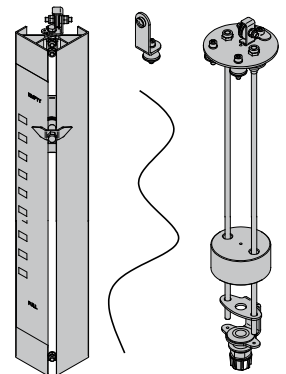

INSTALLATION

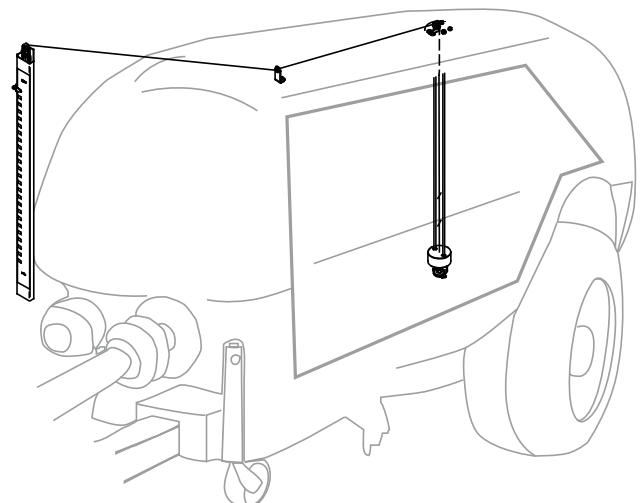

Indicatore di livello con galleggiante (senza scala graduata).

Tank level indicator with float (without graduated scale).

Indicateur de niveau avec flotteur (sans échelle graduée).



Part No.	Pack
8212000	5

KIT



Indicatore di livello + Galleggiante
Tank level indicator + Float
Indicateur de niveau + Flotteur

OPTIONALS

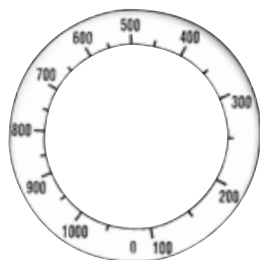

Part No.	Range	Pack
8212001	Neuter	5
8212002	0 ÷ 1000	5
8212003	0 ÷ 1500	5
8212004	0 ÷ 2000	5

Scala graduata
Graduated scale
Echelle graduée

INSTALLATION



Non compreso nel kit
Not included
Non compris dans le kit

Indicatore di livello esterno, completo di tubo.

Tank level indicator including tube.

Indicateur de niveau avec tuyau.



L = 1,5 m

Non compreso nel kit
Not included
Non compris dans le kit

Part No.	Pack
8212005	5

GeoMix 4



Lavacontenitori di fitofarmaci con comando di sicurezza.
 Cisterna in polietilene da 40 l.
 Oblò per ispezione miscelatore.
 Adattabile ad ogni tipo di macchina da diserbo.

- Cisterna in polietilene con oblò di controllo;
- Lavabarattoli con apertura di sicurezza a pressione;
- Ugelli in ceramica per miscelazione;
- Getto rotante lavabotte premix;
- Comando getto rotante lavabotte;
- Comando miscelazione;
- Comando eiettore per incorporazione in cisterna;
- Rete di protezione in plastica.

*Phytosanitary product container washing unit with safety control.
 40-litre polyethylene tank.
 Mixer inspection window.
 Adaptable to any type of spraying machine.*

- Tank in rotational polyethylene with transparent control cover.
- Container washer with pressure operated safety valve.
- Ceramic mixer nozzles.
- Rotating nozzle for cleaning internal surfaces.
- Rotating nozzle for internal cleaning lever control.
- Mixer control.
- Injector / transfer control.
- Protective grill in plastic.

*Lave-conteneurs de produits phytopharmaceutiques avec commande de sécurité.
 Cuve en polyéthylène de 40 l.
 Hublot de visite du mélangeur.
 Adaptable à tout type de pulvérisateurs.*

- Cuve en polyéthylène rotative, avec hublot de contrôle.
- Lave-recipientes avec ouverture de sécurité a pression.
- Buses en céramique pour pré-mélange.
- Jet rotatif pour nettoyer la trémie
- Régulateur du jet rotatif.
- Régulateur premelangeur.
- Régulateur l'éjecteur pour incorporation en cuve.
- Réseau de protection en plastique.

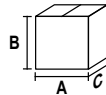

Part No.	Color	I	bar	A mm	B mm	C mm	kg	Pack
8199018								
8199020		40	15	504	632	399	15	1
8199021								
8199023								

DIMENSIONS

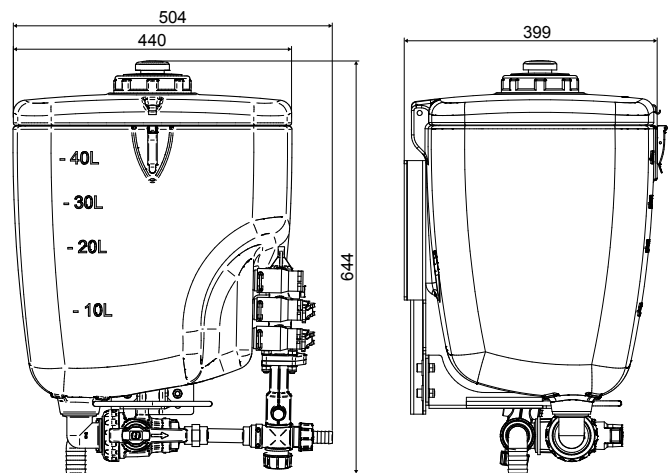

CERTIFICATION



OPTIONAL

GeoMix 4

Supporto a parallelogramma (manuale).

Parallelogram support (manual)

Support à parallélogramme (manuel)



Part No.	L mm	H mm	kg	Pack
8199019	240	480	10,8	1

DIMENSIONS

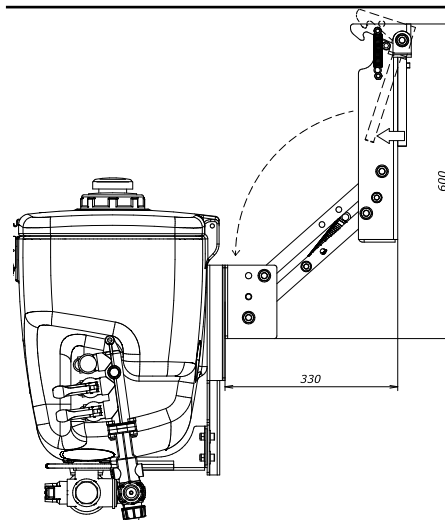

OPTIONAL

GeoMix 4

Kit di aspirazione per prodotti chimici in polvere prelevati direttamente dal contenitore. Adatto per GeoMix4.

Suction kit for powdered chemical products drawn directly from the container. Suitable to GeoMix4.



Kit d'aspiration de produits chimiques en poudre prélevés directement dans leur conditionnement. Approprié à GeoMix4.



Part No.	HOSE LENGTH mm	Pack
K00112006	1500	1

LEGENDA



Campo di impiego / Use / Utilisation

- | | | | | | |
|--|--|---|---|---|---|
|  | Per macchine a basso volume
<i>For low-volume spraying machines</i>
<i>Pour machines basse volum</i> |  | Per atomizzatori
<i>For orchard sprayers</i>
<i>Pour atomiseurs</i> |  | Per macchine da diserbo
<i>For crop sprayers</i>
<i>Pour pulvérisateurs</i> |
|--|--|---|---|---|---|

Caratteristiche / Features / Caracteristiques

- | | | | | | |
|--|---|---|--|---|---|
|  | Portata
<i>Flow rate</i>
<i>Débit</i> |  | Pressione d'esercizio
<i>Operating pressure</i>
<i>Pression de service</i> |  | Per testine attacco rapido
<i>For quick fitting caps</i>
<i>Pour têtes à raccord rapide</i> |
|--|---|---|--|---|---|

FEATURES

- | | |
|---|--|
|  | Prodotti non per uso alimentare
<i>Products not for food use</i>
<i>Produits non pour un usage alimentaire</i> |
|  | Temperatura massima
<i>Max temperature</i>
<i>Temperature maxi</i> |

Accessori opzionali Optionals Accessoires optionals

- | | |
|---|---|
|  | Testine serraugello
<i>Nozzle caps</i>
<i>Têtes de buse</i> |
|  | Ugelli
<i>Nozzles</i>
<i>Buses</i> |
|  | Fascette di montaggio per DRY BOOM
<i>DRY BOOM mounting clamps</i>
<i>Brides de montage pour DRY BOOM</i> |

Ugelli e portaugelli

Tutti i portaugelli GEOLINE hanno struttura in nylon 66, guarnizioni in EPDM o VITON® e particolari metallici interni in acciaio inox AISI 304

Portaugelli

- Corpo in Nylon ad alta resistenza
- Membrana in EPDM, o in Viton®
- Valvola antigoccia tarata a 0,5 bar (a richiesta 0.2; 0.3; 1.0; 1.8 bar)

Testine attacco rapido

- Disponibili in una vasta gamma di colori
- Guarnizioni interne in EPDM, a richiesta in Viton®.

Nozzles and nozzle holders

All GEOLINE nozzle holders have a nylon 66 structure.

They are equipped with EPDM gaskets (VITON® on demand) and AISI 304 stainless steel internal parts.

Nozzle holders

- Nylon body
- Rubber diaphragm in EPDM or Viton®
- Diaphragm check valve calibrated to 0.5 bar (0.2; 0.3; 1.0; 1.8 bar on demand)

Quick caps

- available in a wide range of colours
- EPDM gaskets; Viton® on demand

Buses et porte-buses

Tous les porte-buses GEOLINE ont une structure en nylon 66.

Les joints sont en EPDM (VITON® sur demande) et les parties intérieures en acier inoxydable AISI 304.

Porte-buses

- Corps en nylon
- Membrane en EPDM ou Viton®
- Antigoutte tarée à 0.5 bar (0.2; 0.3; 1.0; 1.8 bar sur demande)

Ecrous à raccord rapide

- En vaste gamme de couleurs
- Joint EPDM ou Viton® sur demande



Portaugelli con antigoccia a membrana in EPDM/VITON® completi di o-ring di tenuta, vite e dado di fissaggio. Attacco rapido. (testine non incluse)

Nozzle holders with diaphragm check-valve EPDM/VITON®, including o-ring gasket, fixing screw and nut. Quick fitting. (caps not included)

Porte-buse avec antigoutte à membrane, avec joint torique en EPDM/VITON®, vis et écrou de fixation inclus. Raccord rapide. (têtes non comprises)



Portaugelli per 2 ugelli.
Double nozzle holders.
Porte-buses à 2 sorties.



EPDM		VITON®						
Part No.	Part No.	Type	F mm	D	B mm	bar	Pack	
8244200	8244204	RH	10	20 mm	23,5	20	10	
8244201	8244205		10	25 mm	26,3			
8244202	8244206		10	1/2"	23,5			
8244203	8244207		10	3/4"	26,3			

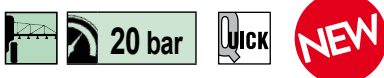

Portaugelli per 3 ugelli.
Triple nozzle holders.
Porte-buses à 3 sorties.



EPDM		VITON®								
Part No.	Part No.	Type	F mm	D	B mm	bar	Pack			
8244208	8244214	RH	7	20 mm	23,5	20	10			
8244220	8244226		10	20 mm	23,5					
8244232	8244238		10	22 mm	23,5					
8244244	8244250		10	25 mm	26,3					
8244256	8244268		7	1/2"	23,5					
8244280	8244292		10	1/2"	23,5					
8244304	8244316		10	3/4"	26,3					
8244328	8244346		10	1"	29,5					
8244209	8244215		LH	7	20 mm			23,5	20	10
8244221	8244227			10	20 mm			23,5		
8244233	8244239	10		22 mm	23,5					
8244245	8244251	10		25 mm	26,3					
8244257	8244269	7		1/2"	23,5					
8244281	8244293	10		1/2"	23,5					
8244305	8244317	10		3/4"	26,3					
8244329	8244347	10		1"	29,5					



Portaugelli per 4 ugelli.
Quadruple nozzle holders.
Porte-buses à 4 sorties.



EPDM		VITON®								
Part No.	Part No.	Type	F mm	D	B mm	bar	Pack			
8244210	8244216	RH	7	20 mm	23,5	20	10			
8244222	8244228		10	20 mm	23,5					
8244234	8244240		10	22 mm	23,5					
8244246	8244252		10	25 mm	26,3					
8244258	8244270		7	1/2"	23,5					
8244282	8244294		10	1/2"	23,5					
8244306	8244318		10	3/4"	26,3					
8244330	8244348		10	1"	29,5					
8244211	8244217		LH	7	20 mm			23,5	20	10
8244223	8244229			10	20 mm			23,5		
8244235	8244241	10		22 mm	23,5					
8244247	8244253	10		25 mm	26,3					
8244259	8244271	7		1/2"	23,5					
8244283	8244295	10		1/2"	23,5					
8244307	8244319	10		3/4"	26,3					
8244331	8244349	10		1"	29,5					



Portaugelli per 5 ugelli.
Quintuple nozzle holders.
Porte-buses à 5 sorties.



		EPDM	VITON®					
Part No.	Part No.	Type	F mm	D	B mm	bar	Pack	
8244212	8244218		7	20 mm	23,5			
8244224	8244230		10	20 mm	23,5			
8244236	8244242		10	22 mm	23,5			
8244248	8244254	RH	10	25 mm	26,3	20	10	
8244260	8244272		7	1/2"	23,5			
8244284	8244296		10	1/2"	23,5			
8244308	8244320		10	3/4"	26,3			
8244332	8244350		10	1"	29,5			
8244213	8244219		7	20 mm	23,5			
8244225	8244231		10	20 mm	23,5			
8244237	8244243		10	22 mm	23,5			
8244249	8244255	LH	10	25 mm	26,3	20	10	
8244261	8244273		7	1/2"	23,5			
8244285	8244297		10	1/2"	23,5			
8244309	8244321		10	3/4"	26,3			
8244333	8244351		10	1"	29,5			

TYPE



RH
Versione con antigoccia a destra.
Version with check-valve right.
Version avec antigoutte - goutte.



LH
Versione con antigoccia a sinistra.
Version with check-valve left.
Version avec antigoutte - gauche.

OPERATION

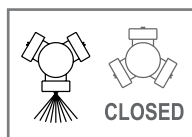

DIMENSIONS

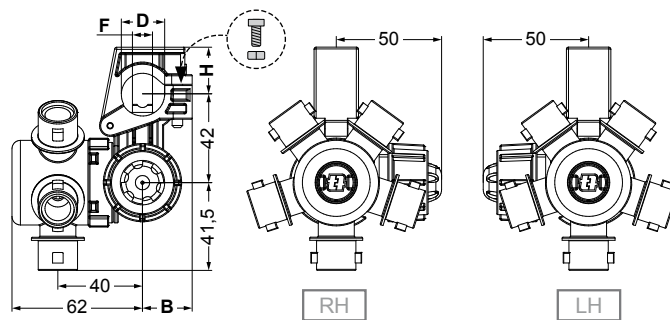

SPARE PARTS

Part No.	Diaphragm Material	Pack	Part No.	F mm	Pack
M0010000	EPDM	50	G00001006	7	50
M00100001	VITON®		G00001008	10	

OPTIONALS



Portaugelli con antigoccia a membrana in EPDM/VITON® completi di o-ring di tenuta, vite e dado di fissaggio. Attacco rapido. (testine non incluse)

Nozzle holders with diaphragm check-valve EPDM/VITON®, including o-ring gasket, fixing screw and nut. Quick fitting. (caps not included)

Porte-buse avec antigoutte à membrane, avec joint torique en EPDM/VITON®, vis et écrou de fixation inclus. Raccord rapide. (têtes non comprises)

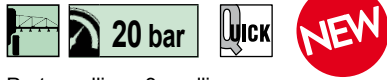

Portaugelli per 3 ugelli.
Triple nozzle holders.
Porte-buses à 3 sorties.



EPDM		VITON®		Type	F mm	D	B mm	bar	Pack
Part No.	Part No.	Part No.	Part No.						
8244262	8244274				7	1/2"	23,5		
8244286	8244298			RH	10	1/2"	23,5	20	10
8244310	8244322				10	3/4"	26,3		
8244334	8244352				10	1"	29,5		
8244263	8244275				7	1/2"	23,5		
8244287	8244299			LH	10	1/2"	23,5	20	10
8244311	8244323				10	3/4"	26,3		
8244335	8244353				10	1"	29,5		

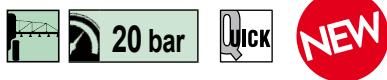

Portaugelli per 4 ugelli.
Quadruple nozzle holders.
Porte-buses à 4 sorties.



EPDM		VITON®		Type	F mm	D	B mm	bar	Pack
Part No.	Part No.	Part No.	Part No.						
8244264	8244276				7	1/2"	23,5		
8244288	8244300			RH	10	1/2"	23,5	20	10
8244312	8244324				10	3/4"	26,3		
8244336	8244354				10	1"	29,5		
8244265	8244277				7	1/2"	23,5		
8244289	8244301			LH	10	1/2"	23,5	20	10
8244313	8244325				10	3/4"	26,3		
8244337	8244355				10	1"	29,5		

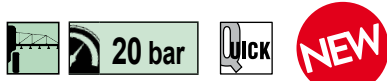

Portaugelli per 5 ugelli.
Quintuple nozzle holders.
Porte-buses à 5 sorties.



EPDM		VITON®		Type	F mm	D	B mm	bar	Pack
Part No.	Part No.	Part No.	Part No.						
8244266	8244278				7	1/2"	23,5		
8244290	8244302			RH	10	1/2"	23,5	20	10
8244314	8244326				10	3/4"	26,3		
8244338	8244356				10	1"	29,5		
8244267	8244279				7	1/2"	23,5		
8244291	8244303			LH	10	1/2"	23,5	20	10
8244315	8244327				10	3/4"	26,3		
8244339	8244357				10	1"	29,5		

Dry Boom Fixing



TYPE

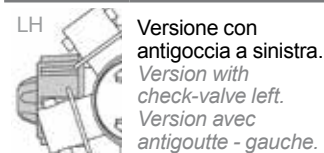
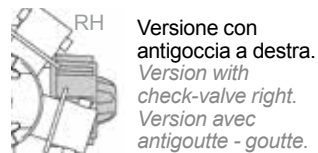

OPERATION

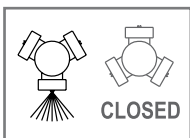

DIMENSIONS

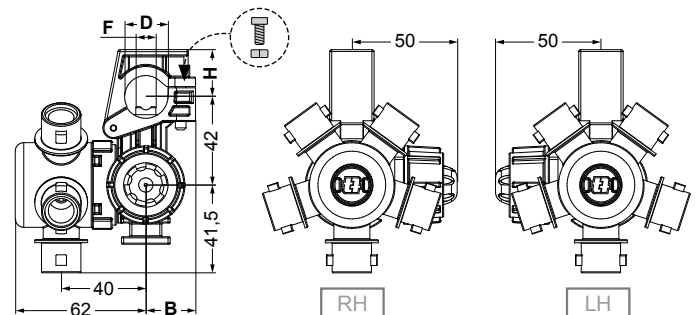

SPARE PARTS

Part No.	Diaphragm Material	Pack
M0010000	EPDM	50
M0010001	VITON®	

Part No.	F mm	Pack
G00001006	7	50
G00001008	10	

OPTIONALS

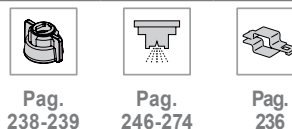

Portaugelli per 3 ugelli con antigoccia a membrana in EPDM/VITON® completi di O-ring di tenuta. Attacco rapido (testine non incluse).

Triple nozzle holders with diaphragm check-valve EPDM/VITON® and O-ring gasket. Quick fitting (caps not included).

Porte-buses à 3 sorties avec antigoutte à membrane en EPDM/VITON® et joint torique. Raccord rapide (têtes non comprises).

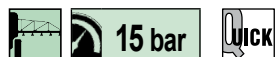

DIMENSIONS

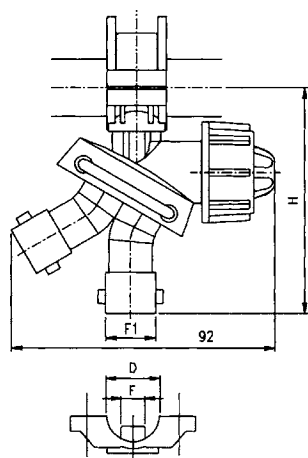

OPERATION

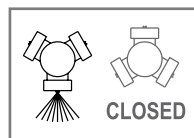

EPDM		VITON®					
Part No.	Part No.	F1	F mm	D	B mm	bar	Pack
8239001	8239011	QUICK	7	1/2"	82	15	10
8239003	8239013		10	1/2"	82		
8239005	8239015		10	3/4"	87		
8239021	8239023		10	1"	87		

SPARE PARTS

Part No.	Diaphragm Material	Pack	Part No.	F mm	Pack
M0010000	EPDM	50	G00001006	7	50
M00100001	VITON®		G00001008	10	

OPTIONALS



Pag. 238



Pag. 246-274



Part No.	Pack
K00001000	10

Kit vite di fissaggio.
Screw kit.
Kit vis de fixation.

Portaugelli per 3 ugelli con antigoccia a membrana in EPDM/VITON®. Attacco rapido (testine non incluse).

Triple nozzle holders with diaphragm check-valve EPDM/VITON®. Quick fitting (caps not included).

Porte-buses à 3 sorties avec antigoutte à membrane en EPDM/VITON®. Raccord rapide (têtes non comprises).

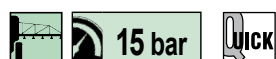

DIMENSIONS

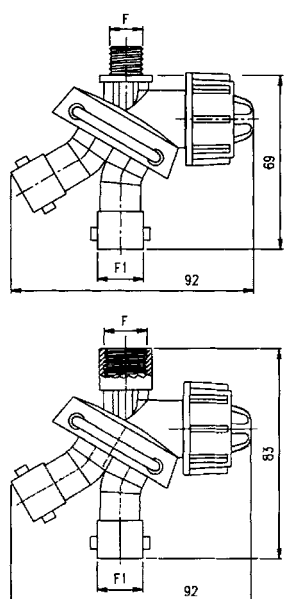

EPDM		VITON®					
Part No.	Part No.	F1	F	bar	Pack		
8239007	8239017	QUICK	1/4 NPT M	15	10		
8239009	8239019		G 3/8 F				

SPARE PARTS

Part No.	Diaphragm Material	Pack
M00100000	EPDM	50
M00100001	VITON®	

OPERATION

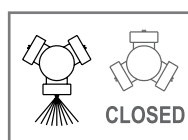

OPTIONALS



Pag. 238-239



Pag. 246-274

Portaugelli con antigoccia a membrana in EPDM/VITON® con rubinetto di chiusura completi di o-ring di tenuta, vite e dado di fissaggio. La valvola antigoccia con rubinetto di chiusura permette, ruotando la ghiera rossa posta sull'antigoccia, di chiudere ogni singolo portaugello. Attacco rapido. Testine non incluse.

Nozzle holders with diaphragm check-valve in EPDM/VITON® with stopcock, including o-ring gasket, fixing screw and nut. The check-valve with stopcock allows each individual nozzle holder to be closed by turning the red ring nut located on the check-valve. Quick fitting. Caps not included.

Porte-buses avec anti-goutte à membrane en EPDM/VITON® avec robinet de fermeture et joint torique de tenue, vis et écrou de fixation. La vanne anti-goutte avec robinet de fermeture permet, en tournant la bague rouge sur l'anti-goutte, de fermer chaque porte-buse. Raccord rapide. Têtes non comprises.

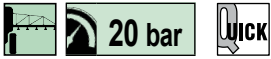

EPDM		VITON®				
Part No.	Part No.	F1	F mm	D	bar	Pack
8234081	8234088		7	20 mm		
8234082	8234089		10	20 mm		
8234083	8234090		7	1/2"		
8234084	8234091	QUICK	10	1/2"	20	25
8234085	-		10	25 mm		
8234086	8234092		10	3/4"		
8234087	8234093		10	1"		

Valvola antigoccia con rubinetto di chiusura manuale. Permette di chiudere ogni singolo portaugello.

Manual ON-OFF Check Valve. Enables the user to close each single nozzle individually.

Valve antigoutte avec robinet de fermeture manuel. Elle permet de fermer chaque porte-buse individuellement.



Part No.	bar	Type	Pack
8257002	0,5	EPDM	25
8257003	0,5	VITON®	

MOUNTING

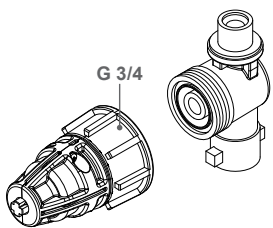

OPERATION

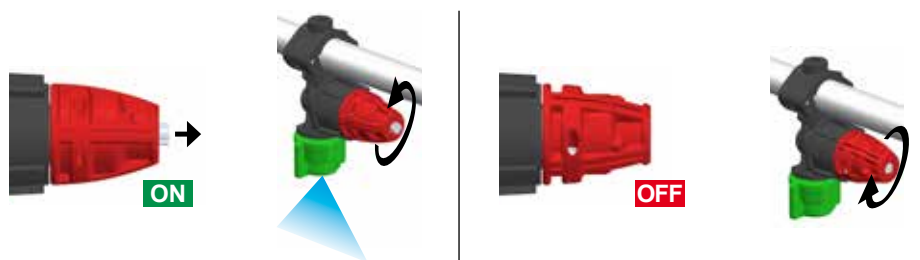

Portaugelli con antigoccia a membrana in EPDM/VITON® con rubinetto di chiusura completi di o-ring di tenuta, vite e dado di fissaggio.

La valvola antigoccia con rubinetto di chiusura permette, ruotando la ghiera rossa posta sull'antigoccia, di chiudere ogni singolo portaugello.

Attacco rapido.

Testine non incluse.

Nozzle holders with diaphragm check-valve in EPDM/VITON® with stopcock, including o-ring gasket, fixing screw and nut.

The check-valve with stopcock allows each individual nozzle holder to be closed by turning the red ring nut located on the check-valve.

Quick fitting.

Caps not included.

Porte-buses avec anti-goutte à membrane en EPDM/VITON® avec robinet de fermeture et joint torique de tenue, vis et écrou de fixation.

La vanne anti-goutte avec robinet de fermeture permet, en tournant la bague rouge sur l'anti-goutte, de fermer chaque porte-buse.

Raccord rapide.

Têtes non comprises.



EPDM		VITON®			
Part No.	Part No.	F1	F	bar	Pack
8234094	8234098	G 3/8 M	G 1/4 F	20	25
8234095	8234099		G 1/4 M		
8234096	8234100		G 3/8 F		
8234097	8234101		11/16 F		

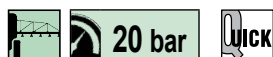

EPDM		VITON®			
Part No.	Part No.	F1	F	bar	Pack
8234102	8234108	QUICK	G 1/4 F	20	25
8234103	8234109		1/4 NPT F		
8234104	8234110		G 1/4 M		
8234105	8234111		1/4 NPT M		
8234106	8234112		G 3/8 F		
8234107	8234113		11/16 F		

Portaugello con antigoccia a membrana. O-ring di tenuta e testina filettata colore rosso.

Nozzle holders with diaphragm check-valve, sealing O-ring and red coloured threaded cap.

Porte-buses avec antigoutte à membran, joint torique de tenue et tête filetée de couleur rouge.



DIMENSIONS

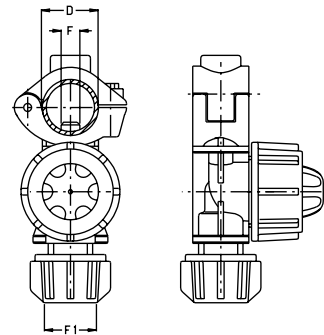

OPERATION

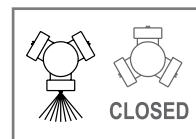

		EPDM	VITON®			
Part No.	Part No.	F1	F mm	D	bar	Pack
8234000	8234016		7	20 mm		
8234002	8234018		10	20 mm		
8234004	8234020		7	1/2"		
8234006	8234022	G 3/8 M	10	1/2"	20	25
8234047	8234048		10	25 mm		
8234008	8234024		10	3/4"		
8234050	-		10	1"		

SPARE PARTS

Part No.	Diaphragm Material	Pack
M0010000	EPDM	50
M0010001	VITON®	

Part No.	F mm	Pack
G00001006	7	50
G00001008	10	

OPTIONALS



Pag. 238-239



Pag. 246-274



Part No.	Type	Pack
V00007005	PH	25
V00007000	TORX 10x7.5	

Vite di fissaggio.
Screw.
Vis de fixation.

Portaugello con antigoccia a membrana e O-ring di tenuta. Attacco rapido (testina non inclusa).

Nozzle holders with diaphragm check-valve and O-ring seal. Quick fitting (cap not included).

Porte-buses avec antigoutte à membrane et joint torique. Raccord rapide (tête non comprise).

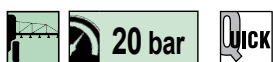

DIMENSIONS

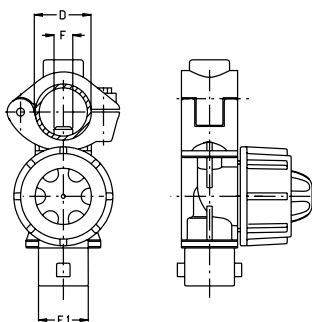

OPERATION

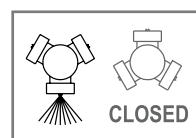

		EPDM	VITON®			
Part No.	Part No.	F1	F mm	D	bar	Pack
8234001	8234017		7	20 mm		
8234003	8234019		10	20 mm		
8234005	8234021		7	1/2"		
8234007	8234023	QUICK	10	1/2"	20	25
8234026	8234027		10	25 mm		
8234009	8234025		10	3/4"		
8234051	-		10	1"		

SPARE PARTS

Part No.	Diaphragm Material	Pack
M0010000	EPDM	50
M0010001	VITON®	

Part No.	F mm	Pack
G00001006	7	50
G00001008	10	

OPTIONALS



Pag. 238-239



Pag. 246-274



Part No.	Type	Pack
V00007005	PH	25
V00007000	TORX 10x7.5	

Vite di fissaggio.
Screw.
Vis de fixation.

Portaugello con antigoccia a membrana e testina filettata colore rosso.

Nozzle holders with diaphragm check-valve and red coloured threaded cap.

Porte-buse avec antigoutte à membrane et tête filettée de couleur rouge.



DIMENSIONS

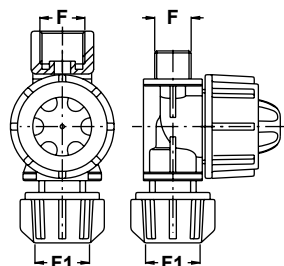

OPTIONALS



Pag. 238-239



Pag. 246-274

EPDM **VITON®**

Part No.	Part No.	F1	F	bar	Pack
8234012	8234028		G 1/4 M		
8234014	8234030	G 3/8 M	G 3/8 F	20	25
8234032	8234036		G 11/16 F		
8234010	8234034		G 1/4 F		

SPARE PARTS



Part No.	Diaphragm Material	Pack
M00100000	EPDM	50
M00100001	VITON®	

Portaugello con antigoccia a membrana. Attacco rapido (testina non inclusa).

Nozzle holders with diaphragm check-valve. Quick fitting (cap not included).

Porte-buse avec antigoutte à membrane. Raccord rapide (tête non comprise).

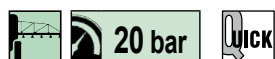

DIMENSIONS

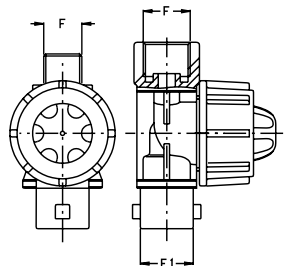

OPTIONALS



Pag. 238-239



Pag. 246-274

EPDM **VITON®**

Part No.	Part No.	F1	F	bar	Pack
8234013	8234029		G 1/4 M		
8234011	8234043		1/4 NPT M		
8234015	8234031	QUICK	G 3/8 F	20	25
8234035	8234041		11/16 F		
8234037	8234045		1/4 NPT F		
8234033	8234039		G 1/4 F		

SPARE PARTS



Part No.	Diaphragm Material	Pack
M00100000	EPDM	50
M00100001	VITON®	

Portaugello con antigoccia a membrana.

Nozzle holders with diaphragm check-valve

Porte-buse avec antigoutte à membrane.



DIMENSIONS

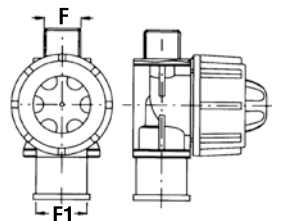

OPTIONALS



Pag. 238-239



Pag. 246-274

EPDM **VITON®**

Part No.	Part No.	F1	F mm	bar	Pack
8234040	8234044	1/4 NPT F	1/4 NPT M	20	25

SPARE PARTS



Part No.	Diaphragm Material	Pack
M00100000	EPDM	50
M00100001	VITON®	

Portaugello completo di O-ring di tenuta e testina filettata colore rosso.

Nozzle holder with O-ring seal and red coloured threaded cap.

Porte-buse avec joint torique et tête fileté de couleur rouge.



DIMENSIONS

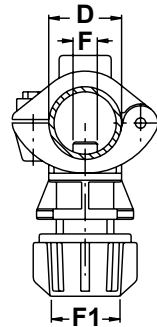

Part No.	F1	F mm	D	bar	Pack
8230000		7	20 mm		
8230002		10	20 mm		
8230004	G 3/8 M	7	1/2"	20	25
8230006		10	1/2"		
8230008		10	3/4"		
8230010		10	1"		

SPARE PARTS

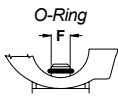

Part No.	F mm	Pack
G00001006	7	50
G00001008	10	

OPTIONALS



Pag. 238-239



Pag. 246-274



Part No.	Type	Pack
V00007005	PH	25
V00007000	TORX 10x75	

Vite di fissaggio.
Screw.
Vis de fixation.

Portaugello completo di O-ring di tenuta. Attacco rapido (testina non inclusa).

Nozzle holder with O-ring seal. Quick fitting (cap not included).

Porte-buse avec joint torique. Raccord rapide (tête non comprise).

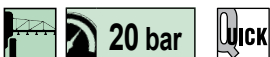

DIMENSIONS

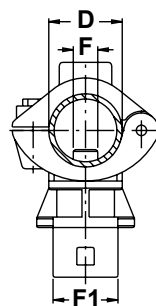

Part No.	F1	F mm	D	bar	Pack
8230001		7	20 mm		
8230003		10	20 mm		
8230005	QUICK	7	1/2"	20	25
8230007		10	1/2"		
8230009		10	3/4"		
8230011		10	1"		

SPARE PARTS

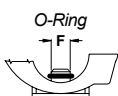

Part No.	F mm	Pack
G00001006	7	50
G00001008	10	

OPTIONALS



Pag. 238-239



Pag. 246-274



Part No.	Type	Pack
V00007005	PH	25
V00007000	TORX 10x75	

Vite di fissaggio.
Screw.
Vis de fixation.

Portaugello completo di O-ring di tenuta e testina filettata colore rosso.

Nozzle holder with O-ring seal and red coloured threaded cap.

Porte-buse avec joint torique et tête filettée de couleur rouge.



DIMENSIONS

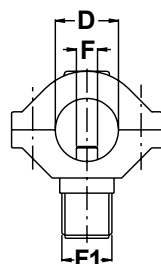

Part No.	F1	F mm	D	bar	Pack
8230012	G 3/8 M	7	1/2"	20	25

SPARE PARTS

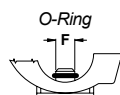

Part No.	F mm	Pack
G00001006	7	50

OPTIONALS



Pag. 238-239



Pag. 246-274



Part No.	Pack
K00001000	10

Kit vite di fissaggio.
Screw kit.
Kit vis de fixation.

Portaugello completo di O-ring di tenuta. Attacco rapido (testina non inclusa).

Nozzle holder with O-ring seal. Quick fitting (cap not included).

Porte-buse avec joint torique. Raccord rapide (tête non comprise).

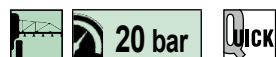

DIMENSIONS

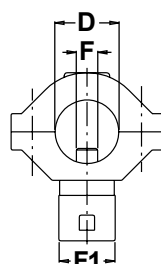

Part No.	F1	F mm	D mm	bar	Pack
8230013	QUICK	7	1/2"	20	25

SPARE PARTS

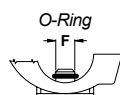

Part No.	F mm	Pack
G00001006	7	50

OPTIONALS



Pag. 238-239



Pag. 246-274



Part No.	Pack
K00001000	10

Kit vite di fissaggio.
Screw kit.
Kit vis de fixation.

Morsetto con battuta piana

Flat seat clamp

Etrier à siège plat



DIMENSIONS

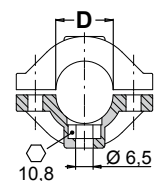

Part No.	D	Pack
8294013	1/2"	
8294027	3/4"	25
8294026	1"	

OPTIONALS



Part No.	Pack
K00001000	10

Kit vite di fissaggio.
Screw kit.
Kit vis de fixation.

Portaugelli registrabili per barre diserbo.
Completi di testina filettata colore rosso.

Nozzle holders for dry booms.
Complete with red coloured threaded cap.

Porte-buses pour rampes de pulvérisation. Avec
tête fileté de couleur rouge.



Part No.	Ø mm	Pack
8231000	10 (3/8")	
8231002	13 (1/2")	25
8231004	19 (3/4")	

Part No.	Ø mm	Pack
8231006	10 (3/8")	
8231008	13 (1/2")	25
8231010	19 (3/4")	

Part No.	Ø mm	Pack
8231012	10 (3/8")	
8231014	13 (1/2")	25
8231016	19 (3/4")	

Dry Boom Fixing



OPTIONALS



Pag. 238-239



Pag. 246-274



Pag. 236

Portaugelli registrabili per barre diserbo.
Attacco rapido (testina non inclusa).

Nozzle holders for dry booms.
Quick fitting (cap not included).

Porte-buses pour rampes de pulvérisation.
Raccord rapide (tête non comprise).

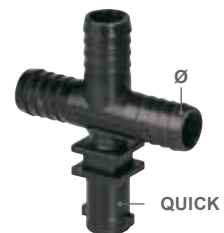
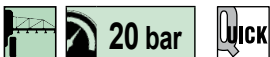

Part No.	Ø mm	Pack
8231001	10 (3/8")	
8231003	13 (1/2")	25
8231005	19 (3/4")	

Part No.	Ø mm	Pack
8231007	10 (3/8")	
8231009	13 (1/2")	25
8231011	19 (3/4")	

Part No.	Ø mm	Pack
8231013	10 (3/8")	
8231015	13 (1/2")	25
8231017	19 (3/4")	

Dry Boom Fixing



OPTIONALS



Pag. 238-239



Pag. 246-274



Pag. 236

Portaugelli registrabili per barre diserbo, con antigoccia a membrana (EPDM). Attacco rapido (testina non inclusa).

Nozzle holders for dry booms, with diaphragm check-valve (EPDM). Quick fitting (cap not included).

Porte-buses pour rampes de pulvérisation, avec antigoutte à membrane (EPDM). Raccord rapide (tête non comprise).

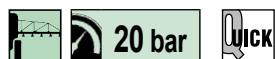

Part No.	Ø mm	Pack
8235001	10 (3/8")	
8235003	13 (1/2")	25
8235005	19 (3/4")	

Part No.	Ø mm	Pack
8235007	10 (3/8")	
8235009	13 (1/2")	25
8235011	19 (3/4")	

Part No.	Ø mm	Pack
8235013	10 (3/8")	
8235015	13 (1/2")	25
8235017	19 (3/4")	

Part No.	Ø mm	Pack
8235019	10 (3/8")	
8235021	13 (1/2")	25
8235023	19 (3/4")	

Part No.	Ø mm	Pack
8235025	10 (3/8")	
8235027	13 (1/2")	25
8235029	19 (3/4")	

Dry Boom Fixing



SPARE PARTS

Part No.	Diaphragm Material	Pack
M00100000	EPDM	50
M00100001	VITON®	

OPTIONALS



Pag. 238-239



Pag. 246-274



Pag. 236

Portaugello registrabile per 3 ugelli con antigoccia a membrana (EPDM) per barre da diserbo. Attacco rapido (testine non incluse).

Adjustable triple nozzle holders with diaphragm (EPDM) check-valve for dry booms. Quick fitting (caps not included).

Porte-buses réglable pour rampes à 3 sorties avec antigoutte à membrane (EPDM). Raccord rapide (têtes non comprises).

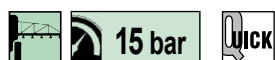

Part No.	Ø mm	Pack
8240001	13 (1/2")	25
8240003	19 (3/4")	

Part No.	Ø mm	Pack
8240005	13 (1/2")	25
8240007	19 (3/4")	

Part No.	Ø mm	Pack
8240009	13 (1/2")	25
8240011	19 (3/4")	

Dry Boom Fixing



SPARE PARTS

Part No.	Diaphragm Material	Pack
M00100000	EPDM	50
M00100001	VITON®	

OPTIONALS



Pag. 238-239



Pag. 246-274



Pag. 236

Portaugelli registrabili con antigoccia a membrana (EPDM) per barre diserbo 13 mm. Attacco rapido (testine non incluse).

Nozzle holders with diaphragm (EPDM) check-valve for dry booms 13 mm. Quick fitting (caps not included).

Porte-buses pour rampes de pulvérisation 13 mm avec antigoutte à membrane (EPDM). Raccord rapide (têtes non comprises).

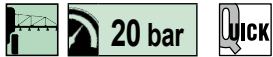

SINGLE LEFT



DOUBLE



SINGLE RIGHT

Part No.	Ø mm	Pack
8235035	13 (1/2")	25

Part No.	Ø mm	Pack
8235033	13 (1/2")	25

Part No.	Ø mm	Pack
8235031	13 (1/2")	25

SPARE PARTS

Part No.	Diaphragm Material	Pack
M00100000	EPDM	50
M00100001	VITON®	

OPTIONALS



Pag. 238-239



Pag. 246-274



Pag. 236

Supporto portagomma registrabile con attacco filettato 1/4" NPT per barre diserbo.

Adjustable hosetail with threaded fitting 1/4" NPT for dry booms.

Porte buses réglable 1/4" F NPT à raccord cannelé.



Part No.	Ø mm	Pack
8231018	10 (3/8")	25
8231020	13 (1/2")	
8231022	19 (3/4")	

Part No.	Ø mm	Pack
8231024	10 (3/8")	25
8231026	13 (1/2")	
8231028	19 (3/4")	

Part No.	Ø mm	Pack
8231030	10 (3/8")	25
8231032	13 (1/2")	
8231034	19 (3/4")	

Dry Boom Fixing



OPTIONALS



Pag. 236

CLAMPS

Fascette di montaggio per portaugelli registrabili.

Mounting clamps for nozzle holders.

Brides de montage pour porte-buses.



Part No.	Ø mm	Pack
8235036	26,4 (3/4")	25
8235038	33,3 (1")	
8235040	42 (1"1/4")	



Part No.	Ø mm	Pack
8235037	19 (3/4")	25
8235039	25 (1")	
8235041	31,8 (1"1/4")	
8235043	38 (1"1/2")	

Derivazione a 45° con attacco rapido.
45° Quick coupling.
Raccord de 45°, attache rapide.



Part No.	F	Pack
8230018	QUICK	25



Attacco rapido per testina a 90°.
90° Quick coupling for cap.
Attache rapide pour tête de 90°.



Part No.	F	Pack
8230022	QUICK	25



Terminale barra filetto - attacco rapido a 45°.
Threaded spraying boom terminal – quick coupling elbow (45°).
Terminal de rampe fileté – attache rapide de 45°.



Part No.	F	Pack
8230016	G 1/2"	25
8230014	G 3/4"	25



Adattatori attacco rapido

Quick-fitting adapters

Adaptateurs à raccord rapide



Part No.	F	Pack
8230015	G 1/4" BSP	25
8230017	1/4" NPT	



Part No.	F	Pack
8230019	G 1/4" BSP	25
8230021	1/4" NPT	

Manicotto attacco rapido per lavaggio barra

Boom flushing quick-fitting adapter

Manchon rapide pour lavage de rampe



Part No.	Pack
8253040	25

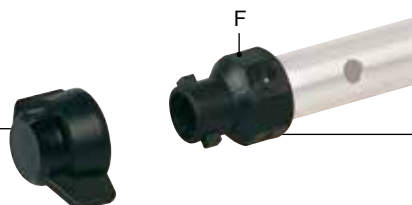

Part No.	F	Pack
8294020	G 3/8" BSP	25
8294021	G 1/2" BSP	
8294022	G 3/4" BSP	

Raccordo portagomma per portaugelli regolabili

Hose fitting for adjustable nozzle holders

Raccord pour porte-buses réglables



DIMENSIONS

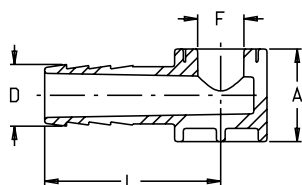

Part No.	A	D mm	F mm	L mm	Pack
8294014	1/2"	13	10,5	40	25
8294015	3/4"	20	10,5	40	
8294016	3/4"	26	10,5	40	
8294023	1/2"	13	7,5	40	
8294028	1"	19	10,5	40	
8294029	1"	25	10,5	40	



DIMENSIONS

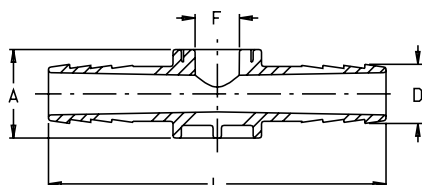









Part No.	A	D mm	F mm	L mm	Pack
8294017	1/2"	13	10,5	80	25
8294018	3/4"	20	10,5	80	
8294019	3/4"	26	10,5	80	
8294024	1/2"	13	7,5	80	
8294030	1"	19	10,5	80	
8294031	1"	25	10,5	80	



QUICK CAPS

P/N	Colour	P/N	Colour	Pack	Suitable for	Spare parts
8253000	red	8253042	orange	25	GEOLINE®: BD, ADGA, RS, EZK, EZK-TWIN, AD, PB, AZ, KR5 ASJ®: SF, SFA, WR, WRC, LD, LDC, EF, TLT, AFC, CFA, CFA-U, OC Albuz®: API, ADI, AXI80, AXI110, OCI, CVI110 Lechler®: IDK, IDKN, IDKT, LU, AD, AD90, ST, IDKS, ES, OC(small size)	G00002020
8253001	yellow	8253043	brown			
8253002	green	8253048	black			
8253003	blue	8253118	grey			
8253041	white	8253119	violet			
8253004	red	8253046	white	25	ASJ®: TFS, TFLD, PSP, BX, TFA Albuz®: APE, EXA, ESI, AVI110, AVIOC, MVI, AVI80, AVI-TWIN	G00002020
8253005	yellow	8253044	orange			
8253006	green	8253045	brown			
8253007	blue	8253055	black			
8253008	red	8253057	brown	25	GEOLINE®: EZ Lechler®: serie 652, serie ID	G00002020
8253009	yellow	8253049	black			
8253010	green	8253120	grey			
8253011	blue	8253121	light blue			
8253056	orange					
8253012	red	8253059	brown	25	ASJ®: DEF, HC Albuz®: APM TeeJet®: TK FloodJet®, FL FullJet®, TG FullCone, TX, AITXA, ConeJet® Lechler®: TR, ITR	G00002020
8253013	yellow	8253050	black			
8253014	green	8253122	light green			
8253015	blue	8253123	white			
8253058	orange	8253124	grey			
8253016	red	8253060	orange	25	DISC AND CORE - AITXA	/
8253017	yellow	8253061	brown			
8253018	green	8253062	black			
8253019	blue					
8253020	red	8253063	orange	25	ASJ®: HCC, HCI80, HCI60, HCI40, NC DC Albuz®: ATR 80, ATR 60, ATI 60, TVI80, ATR, AMPT	G00002020 + G00001060
8253021	yellow	8253064	brown			
8253022	green	8253065	black			
8253023	blue					
8253024	red	8253066	orange	25	TeeJet® Flat Spray tips (larger capacities) Standard: -10 -20 XR -10 -15	G00002020 + G00001060
8253025	yellow	8253067	brown			
8253026	green	8253068	black			
8253027	blue	8253125	white			
8253028	red	8253070	brown	25	GEOLINE®: AD/D, AD-IA, ST-IA, ST, TM-IA, PB-IA, AS-IA, AD/IA-D, AD/T TJ TwinJet®: No. TJ60 Spray Tip TeeJet®: TTI, SJ3, DGTJ60, AI, AIUB, No. AI spray Nozzle	G00002020
8253029	yellow	8253071	black			
8253030	green	8253126	white			
8253031	blue	8253127	light blue			
8253069	orange	8253128	violet			
8253032	red	8253072	orange	25	ASJ®: DEF140, TK-VS FloodJet®, Turbo FloodJet™	G00002020
8253033	yellow	8253073	brown			
8253034	green	8253051	black			
8253035	blue	8253129	white			

	P/N	Colour	P/N	Colour	Pack	Suitable for	Spare parts
	8253036	red	8253074	orange	25	Hardi: flat fan nozzles	G00002020
	8253037	yellow	8253075	brown			
	8253038	green	8253052	black			
	8253039	blue					
	8253086	red	8253090	orange	25	GEOLINE®: MAG	G00002020
	8253087	yellow	8253091	brown			
	8253088	green	8253092	black			
	8253089	blue					
	8253093	red	8253097	orange	25	GEOLINE®: MGA	G00002020
	8253094	yellow	8253098	grey			
	8253095	green	8253099	black			
	8253096	violet					
	8253100	red	8253104	orange	25	GEOLINE®: MAG-CH, CV-IA	G00002020
	8253101	yellow	8253105	violet			
	8253102	green	8253106	black		GEOLINE®: MCP*	*G00002020 + G00001060
	8253103	blue					
	8253107	red			25	GEOLINE®: X	G00002020
	8253108	blue					
	8253109	white					
	8253110	orange					
	8253111	red	8253116	brown	25	GEOLINE®: TKP	G00002020
	8253113	green	8253117	black			
	8253114	blue	8253112	yellow			
	8253115	orange					
	8253040	black			25	CLOSED: PROVIDES SHUTOFF NOZZLE FOR QUICK SPACING CHANGE	G00002020
	8253047	black			25	THREADED CAP 1/4" NPT	G00002020
	8253130	black				THREADED CAP 1/8" NPT	



THREADED CAPS

Part No.	Colour	Type	Pack
8040102	red		25
8040103	yellow		
8040104	green		
8040105	blue		

Girelli G 3/8 serraugelli.
3/8 BSP nozzle fitting fly nuts.
Écrous de buse G 3/8.

Kit testina attacco rapido universale.

- Consente di poter alloggiare tutti i tipi di ugello con Ø8 e Ø10 mm.
- Completa di guarnizione.

Kit for head with universal quick-release coupling.
- Used to fit all types of nozzle with Ø8 and Ø10 mm.
- Complete with gasket.

Kit tête de raccordement rapide universel.
- Permet d'installer tout type de buse de Ø8 et Ø10 mm.
- Dotée de garniture.

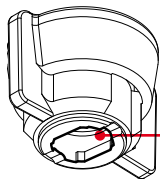
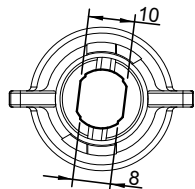

NEW

Sede ugello con doppio centraggio
Nozzle seat with double centring
Logement buse à double centrage

Part No.	color	For nozzles	Type	
			Ø8mm	Ø10mm
8253085	grey			hollow cone
8253084	violet			flood nozzles
8253083	brown			
8253082	orange	Lechler®, Albus®, TeeJet®, Geoline®, Lurmark®, Tecnomat®	IDK, IDKN, IDKT, IDKS,	TR, ITR
8253081	white	Arag®, John Deere®, Hypro®, Vicon®, Douven®, Dubex®, CHD Eefting®, Rau® (from 2000), Inuma®, Dammann®, Jacoby®	AD, LU, ST, ES, OC, ADI, API, APS, ADX	TK FloodJet®, TXA ConeJet®, FL FullJet®, TG Fullcone®
8253080	black		ID, IDN, IS, DF, FL	FT
8253079	blue			AI TeeJet®, TKFloodjet®
8253078	green			VS Floodjet®
8253077	yellow			
8253076	red			
8253131	lilac			

Espositori ugelli Geoline

- completi di ganci;
- materiale: cartone automontante.

Geoline nozzles exhibitors

- Complete with hooks;
- Material: cardboard.

Geoline présentoirs pour buses.

- complet avec crochets
- matériel: carton

Disponibile in due versioni: da banco e appeso

Available in two versions: desk and wall versions.

Disponibles en deux versions: pour comptoir et pour l'affichage au mur.

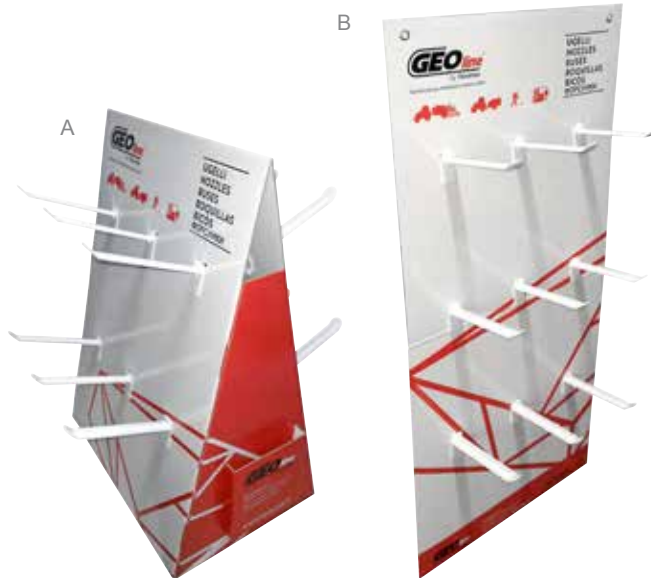

	Part No.	Number of hooks	Number of blister	Pack
A	K99904000	12	60	1
B	K99904001	9	45	1

Vaso misuratore

Measuring jug

Pot gradué



Part No.	Pack
8257000	3

UGELLI

■ Geoline è lieta di presentare la nuova gamma di ugelli per il trattamento alle colture denominata Geoline Tips, realizzata sia in ceramica che in resina acetica, in collaborazione con una importante storica azienda Brasiliana.

■ La gamma realizzata da Geoline copre le più disparate necessità nei trattamenti agricoli offrendo una elevata qualità durata e affidabilità frutto della conoscenza specifica del settore.

■ La nostra gamma di ugelli è prodotta nei colori e nelle portate indicati dalla normativa ISO 10625.

■ Gli ugelli vengono prodotti con diversi materiali adatti alle svariate esigenze utilizzando le migliori resine acetali che, Delrin®, e utilizziamo la ceramica Allumina al 99% di purezza

NOZZLES

■ Geoline is pleased to present its new range of nozzles for treating crops, Geoline Tips, made both in ceramic and acetal resin in collaboration with an important long-standing Brazilian company.

■ Geoline's range covers the most diversified needs in agricultural treatment, offering high quality, long life and reliability thanks to its specific know how in this sector.

■ Our range of nozzles is produced in the colours and with the flow rates indicated in the ISO 10625 standard.

■ The nozzles are made with materials suited to many different requirements, using the best acetal resins, Delrin® and 99% pure alumina ceramic.

BUSES

■ Geoline est heureuse de présenter la nouvelle gamme de buses pour le traitement des cultures, baptisée Geoline Tips et réalisée aussi bien en céramique qu'en résine d'acétal, en collaboration avec une importante et historique entreprise brésilienne.

■ La gamme réalisée par Geoline répond aux besoins les plus divers en matière de traitements agricoles en offrant des gages de qualité durable et de fiabilité qui sont le fruit d'une parfaite connaissance du secteur.

■ Notre gamme de buses est produite dans les couleurs et les débits indiqués par la norme ISO 10625.

■ Les buses sont produites avec différents matériaux qui répondent aux exigences les plus diverses et en recourant aux meilleures résines d'acétal Delrin® et à la céramique alumine pure à 99%.

VMD Classi di grandezza delle gocce / Drop size classes / Classes de grandeur des gouttes

MF	F	M	G	MG	EG
MOLTO FINE VERY SMALL TRÈS FINE	FINE SMALL FINE	MEDIA MEDIUM MOYENNE	GROSSA BIG GROSSE	MOLTO GROSSA VERY BIG TRÈS GROSSE	ESTREM. GROSSA EXTREMELY BIG ULTRA GROSSE
< 150 Microns	150 ÷ 250 Microns	250 ÷ 350 Microns	350 ÷ 450 Microns	450 ÷ 550 Microns	> 550 Microns

TABELLA APPLICATIVA

Secondo i test eseguiti dal Dr. Matthew Novak ed altri ricercatori dell'Università dell'Oregon, negli Stati Uniti, la durata di un ugello in ceramica può superare le 1000 ore di lavoro, a seconda dei fattori indicati di seguito:

* **Pressione:** Maggiore è la pressione, tanto più rapido sarà il processo di usura.

* **Tipo di prodotto:** Quanto più è abrasivo, maggiore sarà il grado di usura.

* **Qualità dell'acqua:** Quante più impurità saranno presenti, tanto più rapido sarà il processo di usura.

* **Pulizia:** Non utilizzare mai oggetti metallici o appuntiti. In caso di intasamenti, usare getti d'aria, acqua pulita o una spazzola con setole di nylon per non danneggiare gli ugelli.

APPLICATION TABLE

According to the tests conducted by Mr. Matthew Novak and other researchers of the Oregon University in the United States, the life of a ceramic nozzle can exceed 1,000 hours of use, depending on the following factors:

* **Pressure:** The nozzle will wear quicker with a higher pressure.

* **Type of product:** The nozzle will wear quicker the more abrasive the product is.

* **Quality of the water:** The more impurities there are in the water the quicker the nozzle will wear.

* **Cleaning:** Never use metal or pointed objects. In the case of clogging, use jets of air, clean water or a nylon bristle brush so as not to damage the nozzles.

TABLEAU DES APPLICATIONS































Conformément aux tests effectués par Matthew Novak et par d'autres chercheurs de l'Université de l'Oregon aux États-Unis, la durée de vie d'une buse en céramique peut dépasser les 1000 heures de fonctionnement en fonction des facteurs suivants :

* **Pression :** plus la pression est élevée, plus l'usure est rapide.



































* **Type de produits :** plus le produit est abrasif, plus le degré d'usure est élevé.

* **Qualité de l'eau :** plus la quantité d'impuretés est élevée, plus l'usure est rapide.

* **Nettoyage :** ne jamais utiliser d'objets métalliques ni pointus ; en cas d'obstruction, pour ne pas endommager les buses, utiliser un jet d'air, de l'eau propre ou une brosse à poils en nylon.

Choose your nozzle	LOW CROPS										
	CERAMIC FLAT NOZZLES										
TYPE OF NOZZLES	BD LOWRED DRIFT FLAT SPRAY	AS-IA TWIN AIR INDUCTION FLAT SPRAY	AD DRIFT REDUCTION FLAT SPRAY	ADGA WIDE ANGLE DRIFT REDUCTION FLAT SPRAY	AD-IA ANTI DRIFT AIR INDUCTION FLAT SPRAY	AD-IA/D TWIN AIR INDUCTION FLAT SPRAY	AD/D TWIN FLAT SPRAY	AD/T TRIPLE FLAT SPRAY	ST-IA AIR INDUCTION SUPER TURBO FLAT SPRAY	ST SUPER TURBO FLAT SPRAY	
											
SPRAY PATTERN											
DROPLETS SIZE CHARACTERISTICS											
DRIFT HAZARDS	Medium	Very Low	Medium	Medium	Very Low	Very Low	Medium	Medium	Very Low	Low	
RECOMMENDED PRESSURES	1 - 4 bar	2 - 7,6 bar	2 - 4 bar	2 - 4 bar	2 - 7.5 bar	2 - 7.5 bar	2 - 4 bar	2,8 - 9 bar	2 - 6,5 bar	1,5 - 6 bar	
HERBICIDES	Incorporated treatment	Excellent	Excellent	Excellent	Excellent	Excellent	Excellent	Excellent	Excellent	Excellent	
	Pre emergent	Excellent	Excellent	Excellent	Excellent	Excellent	Excellent	Excellent	Excellent	Excellent	
	Post emergent	Contact	Good	Good*	Good	Good	Good*	Good*	Excellent	Excellent	Good*
		Systemic	Excellent	Excellent	Excellent	Excellent	Excellent	Excellent	Excellent	Excellent	Excellent
FUNGICIDES	Contact	Good	Good*	Good	Good		Good*	Excellent	Excellent	Good*	
	Systemic	Excellent	Excellent	Excellent	Excellent	Good*	Excellent	Excellent	Excellent	Excellent	
INSECTICIDES	Contact	Good	Good*	Good	Good		Good*	Excellent	Excellent	Good*	
	Systemic	Excellent	Excellent	Excellent	Excellent	Good*	Excellent	Excellent	Excellent	Excellent	

 * for a low pressure

		ORCHARD-VINEYARD: FULL CONE, HOLLOW CONE & FLAT NOZZLES					OTHERS APPLICATIONS						
	PLASTIC	CERAMIC					CERAMIC					PLASTIC	
	AZ	MAG	MGA	MAG-CH	CV-IA	X	TM-IA	PB	PB-IA	MX	DEFLECTOR (TKP)	MCP	
	LOWERED DRIFT POLYACETAL FLAT SPRAY	HOLLOW CONE CERAMIC	HOLLOW CONE ATOMIZED DROPLETS	FULL CONE CERAMIC 80°	AIR INDUCTION HOLLOW CONE	FOGGING HOLLOW CONE	DEFLECTOR TURBO	OFF-CENTER FLAT SPRAY	AIR INDUCTION OFF-CENTER FLAT SPRAY	JET BOOMLESS FLAT	DEFLECTOR POLYACETAL	HOLLOW CONE POLYACETAL	
													
													
													
	Medium	High	High	High	Medium	High	Very Low	Medium	Very Low	Low	Medium	High	
	3 - 4 bar	4 - 20 bar	4,5 - 20 bar	3,5 - 10 bar	3 - 10 bar	5,5 - 13,8 bar	2 - 6 bar	2 - 4 bar	2 - 7,5 bar	2 - 5 bar	1 - 3 bar	2 - 6 bar	
	Excellent						Excellent	Excellent	Excellent	Excellent	Excellent		
	Excellent						Excellent	Excellent	Excellent	Excellent	Excellent		
	Good*							Good			Good		
	Excellent						Excellent	Excellent	Excellent	Excellent	Excellent		
	Good*	Excellent	Excellent	Excellent	Good	Excellent		Good			Good	Excellent	
	Excellent	Excellent	Excellent	Excellent	Excellent	Excellent		Excellent	Good	Good	Good	Excellent	
	Good*	Excellent	Excellent	Excellent	Good	Excellent		Good			Good	Excellent	
	Excellent	Excellent	Excellent	Excellent	Excellent	Excellent		Excellent	Good	Good	Good	Excellent	

Dati importanti sulla tecnologia di atomizzazione

Atomizzazione

Il processo di atomizzazione scompone i liquidi in goccioline. La maggior parte degli ugelli usati in agricoltura sfrutta l'atomizzazione idraulica ottenuta dalla con l'effetto legato alla conformazione della bocca della testina dell'ugello. Questi due fattori aumentano la velocità di efflusso del liquido da atomizzare, convertendo l'energia potenziale in energia cinetica (= velocità). Per effetto dello scarico di tensione subito dal liquido quando esce dall'ugello, si produce una lamella di liquido inizialmente piatta, che man mano diviene ondulata perdendo la sua stabilità. Si creano così strisce di liquido che si disintegrano in goccioline di varie dimensioni.

Specifiche tecniche

I dati prestazionali degli ugelli per agricoltura Geoline sono riportati secondo le indicazioni previste dagli standard internazionali e includono le seguenti informazioni:

- tipo di ugello
- angolo di spruzzo
- dimensioni della testina

Gli ugelli Geoline sono provvisti di codici colore ISO: a ogni colore corrisponde una portata specifica.

Copertura

La copertura teorica di un dato ugello è determinata fondamentalmente dall'angolo e dall'altezza di spruzzo, vale a dire, dalla distanza tra l'ugello e la superficie target da trattare.

In base all'altezza dell'ugello e alle sue dimensioni, l'angolo di spruzzo e l'accuratezza di distribuzione possono dipendere in certa misura dalla pressione di spruzzo. La pressione di spruzzo consigliata sulla testina dell'ugello e l'altezza di spruzzo minima per una distanza specifica tra gli ugelli, sono quindi due requisiti che consentono di ottenere una distribuzione uniforme di liquido secondo la configurazione dello spruzzo prevista.

Si applicano in linea generale le seguenti leggi fisiche di regolarità (i dati nella tabella sono relativi all'acqua):

- Liquidi di spruzzo con viscosità superiori a quella dell'acqua hanno angoli di spruzzo più ridotti.
- Liquidi di spruzzo con minore tensione superficiale di quella dell'acqua hanno angoli di spruzzo più ampi.
- La densità del liquido di spruzzo ha un effetto limitato sull'angolo di spruzzo.

A seguito dell'effetto di caduta del getto di spruzzo, che dal punto di vista fisico è inevitabile, la copertura effettiva può risultare inferiore rispetto alla copertura teorica indicata nella tabella, soprattutto in casi legati a pressione di spruzzo bassa e altezza di spruzzo consistente.

Due to the physically unavoidable effect of spray-jet droop, the effective coverage may fall short of the theoretical coverage listed in the above table, especially in cases involving low spray pressure and substantial spray height.

Suite à l'effet de chute du jet d'aspersion, qui d'un point de vue physique est inévitable, la couverture effective peut être inférieure par rapport à la couverture théorique indiquée dans le tableau, surtout pour des cas liés à une pression d'aspersion basse et une hauteur d'aspersion élevée.

Principal Facts of Spray Nozzle Technology

Atomization

The atomization process breaks liquids down into droplets. Most of the nozzles used in agriculture rely on hydraulic atomization resulting from fluid pressure in combination with the orifice effect of the nozzle tip. Those two factors accelerate the flow velocity of the medium to be atomized. This converts potential energy into kinetic energy (= speed). The release of tension experienced by the liquid as it emerges from the nozzle tip produces an initially flat lamella of liquid that soon loses its stability and becomes wavy. That gives rise to strings of liquid that disintegrate into droplets of various size.

Specification

The performance data of Geoline agricultural spray nozzles are stated in accordance with international standards and include the following information:

- type of nozzle
- spray angle
- tip size

Geoline nozzles are ISO color-coded, with each different color corresponding to a defined flow rate.

Coverage

The theoretical coverage of a given nozzle is chiefly determined by the spray angle and the spray height, i.e., the distance between the nozzle and the target surface. Depending on the height of the nozzle and its size, the spray angle and accuracy of distribution can depend to a certain extent on the spray pressure. Hence, the recommended spray pressure at the nozzle tip and the minimum spray height for a specific nozzle spacing are two prerequisites for the uniform distribution of liquid within the spray pattern.

The following laws of physical regularity apply in principle (data in table based on water):

- Spray media with viscosities higher than that of water have narrower spray angles.
- Spray media with less surface tension than that of water have broader spray angles.
- The density of the spray medium has little effect on the spray angle.

Notes importantes sur la technologie d'atomisation

Atomisation

Le processus d'atomisation décompose les liquides en gouttelettes. La plupart des buses utilisées dans le domaine de l'agriculture exploitent l'atomisation hydraulique obtenue par la pression du liquide combinée avec l'effet lié à la conformation de la bouche de la tête de la buse. Ces deux facteurs augmentent la vitesse d'écoulement du liquide devant être atomisé, par conversion de l'énergie potentielle en énergie cinétique (=vitesse). Sous l'effet de la chute de tension subie par le liquide en sortant de la buse, il se produit une fine lame de liquide initialement plate, qui devient ondulée au fur et à mesure perdant sa stabilité. De ce fait, se créent des bandes de liquide qui se désintègrent en gouttelettes de dimensions variables.

Notes techniques

Les données performantielles des buses pour l'agriculture Geoline sont indiquées selon les indications prévues par les standards internationaux et contiennent les informations suivantes :

- type de buse
- angle d'aspersion
- dimensions de la tête

Les buses Geoline sont pourvues d'un code couleur ISO : chaque couleur correspond à une portée spécifique.

Couverture

La couverture théorique d'une buse donnée est déterminée principalement par l'angle et la hauteur d'aspersion, c'est-à-dire par la distance entre la buse et la surface cible devant être traitée.

En fonction de la hauteur de la buse et de ses dimensions, l'angle d'aspersion et la précision de la distribution peuvent dépendre d'une certaine manière de la pression d'aspersion. La pression d'aspersion conseillée sur la tête de la buse et la hauteur minimum d'aspersion pour une distance donnée entre les buses, sont donc deux qualités requises qui permettent d'obtenir une distribution uniforme du liquide en fonction de la configuration prévue du jet.

Sont généralement appliquées les lois physiques de régularité suivantes (les données figurant dans le tableau correspondent à celles de l'eau) :

- Les liquides d'aspersion d'une viscosité supérieure à celle de l'eau ont un angle d'aspersion plus réduit.
- Les liquides d'aspersion ayant une tension superficielle mineure de celle de l'eau ont un angle d'aspersion plus ample.
- La densité du liquide d'aspersion a un effet limité sur l'angle d'aspersion.

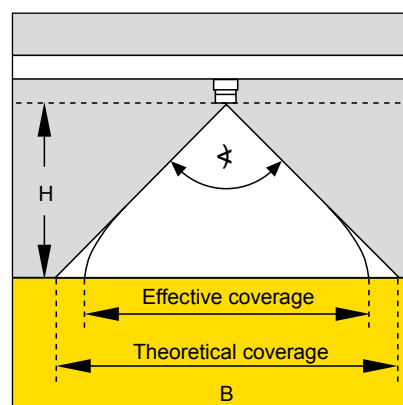

Copertura : Copertura teorica rapportata all'altezza dello spruzzo e all'angolo di spruzzo

Coverage : Theoretical coverage as a function of spray height and spray angle

Couverture : couverture théorique par rapport à la hauteur et à l'angle d'aspersion

Spray angle	Theoretical coverage B for different spray heights H (cm)											
	10	15	20	25	30	40	50	60	70	80	100	120
20°	3.5	5.3	7.1	8.8	10.6	14.1	7.6	1.2	24.7	28.2	35.3	42.0
30°	5.4	8.0	10.7	13.4	16.1	21.4	26.8	32.2	37.5	42.9	53.6	64.0
45°	8.3	12.4	16.6	20.7	24.9	33.1	41.4	49.7	58.0	66.3	82.8	99.0
60°	11.6	17.3	23.1	28.9	34.6	46.2	57.7	69.3	80.8	92.4	115.0	(138.0*)
90°	20.0	30.0	40.0	50.0	60.0	80.0	100.0	120.0	140.0	160.0	200.0	(240.0*)
120°	34.6	52.0	69.3	86.6	104.0	139.0	173.0	208.0	242.0	277.0	(346.0*)	(416.0*)
140°	55.0	82.4	110.0	137.0	165.0	220.0	275.0	(330.0*)	(385.0*)	(440.0*)	(550.0*)	(660.0*)

* Dati tra parentesi: maggior differenza tra l'area di copertura effettiva e teorica.

* Parenthesized data: major difference between effective and theoretical coverage.

* Données entre parenthèses : différence plus importante entre la zone de couverture effective et la zone de couverture théorique.

Parametri di applicazione

I dati applicativi nelle tabelle del presente catalogo sono stati calcolati per sistemi di polverizzazione diffusa con irroratrici a barre e un interasse tra gli ugelli pari a A = 50 cm. Le formule riportate a fianco si possono usare per calcolare le portate per altri intervalli tra gli ugelli.

Di regola, tre dei quattro parametri di applicazione – velocità di trattamento [km/h], dosaggio litri per ettaro [l/ha], portata [l/min], ed interasse tra gli ugelli [cm] – sono noti. I parametri che solitamente sono sconosciuti [l/min; l/ha] si calcolano con le formule riportate a fianco.

Il dosaggio effettivo per coltivazioni a filare, è in funzione del rapporto tra l'intera area realmente trattata, e l'area totale coperta. Il dosaggio reale applicato alla coltivazione, ammonta quindi ad una percentuale (per es. 40%) dell'intero dosaggio distribuito sull'area totale.

Application parameters

The application data in the tables of this catalogue were calculated for broadcast boom sprayers with a lateral nozzle spacing of A = 50 cm. The formulae at right can be used for calculating flow rates for other nozzle spacings.

As a rule, three of the four application parameters – sprayer speed [km/h], liter per hectare rate [l/ha], flow rate [l/min], and nozzle spacing [cm] – are known. The most frequently unknown parameters [l/min; l/ha] are also calculated according to the formulae shown at right.

The actual dosage for banding/row spraying is a function of the ratio between the treated (sprayed) area and the total gross covered area. The specific reduced dosage (liter per gross covered hectare), therefore amounts to a percentage (e.g., 40%) of the full rate per hectare for broadcast spraying.

Paramètres d'application

Les données d'application dans les tableaux de ce catalogue ont été calculées pour des systèmes de pulvérisation d'ensemble à l'aide de pulvérisateurs à barres et une distance entre les axes des buses équivalente à A=50 cm. Les formules indiquées ci-après peuvent être utilisées pour calculer les portées pour d'autres intervalles entre les buses.

Généralement, trois des quatre paramètres d'application - vitesse de traitement [km/h], dosage en litres par hectare [L/ha], portée [L/min] et distance entre les axes des buses [cm] - sont connus. Les paramètres généralement inconnus [L/min ; L/ha] se calculent grâce aux formules reportées ci-contre.

Le dosage effectif pour les cultures en ligne se fait en fonction du rapport entre la zone entière réellement traitée et la zone totale couverte. Le dosage réel appliqué aux cultures s'élève donc à un pourcentage (par ex. 40%) du dosage complet distribué sur la zone entière.

<p>Liter per hectare rate, M (l/ha)</p> $M = \frac{600 \times \dot{V}}{A \times v_F}$ <p>Flow rate / nozzle, \dot{V} (l/min)</p> $\dot{V} = \frac{1}{600} \times M \times A \times v_F$ <p>Lateral nozzle spacing, A (m)</p> <p>Sprayer speed, v_F (km/h)</p>	<p>Sample for calculation of flow rate per nozzle:</p> <p>A = 1 m, v_F = 6km/h,</p> <p>M = 400l/ha</p> $\dot{V} = \frac{400 \times 1 \times 6}{600} = 4 \text{ l/min}$
<p>Band width B [m]</p> <p>Lateral nozzle spacing or row spacing A [m]</p> $\frac{B}{A} \times 100 = \text{treated (sprayed) area as a percentage of total gross covered area}$ <p>Example: $\frac{0,2}{0,5} \times 100 = 40\%$</p>	

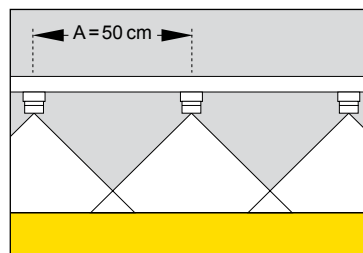

Materiali degli ugelli

La maggior parte degli ugelli per agricoltura è realizzata in plastica (POM), acciaio inossidabile, ceramica e, in alcuni casi, ottone.

Tutti questi materiali sono resistenti ai prodotti chimici noti per la protezione delle piante e tutti, ad eccezione dell'ottone, sono resistenti ai fertilizzanti liquidi.

■ La plastica si distingue per l'elevata precisione, la resistenza all'usura e gli ottimi rapporti prestazioni-prezzo.

■ L'acciaio inossidabile è il materiale ideale per carichi meccanici elevati.

■ Gli ugelli in ceramica sono i più resistenti in assoluto all'usura e quindi sono consigliati per la loro durata di vita estremamente lunga e per le elevate prestazioni specifiche sull'area.

Spray tip materials

Most agricultural spray nozzles are made of plastic (POM), stainless steel, ceramic and, in some cases, brass.

All these materials are resistant to known plant protection chemicals, and all with the exception of brass are resistant to liquid fertilizers.

■ Plastic is conspicuous for high precision, resistance to wear and very good price-performance ratios.

■ Stainless steel is the material of choice for high mechanical loads.

■ Ceramic nozzles are the most wear-resistant of all and therefore recommended for their extremely long service lives and high area specific performance.

Matériaux composant les buses

La plupart des buses destinées à l'agriculture sont réalisées en plastique (POM), en acier inoxydable, en céramique et, dans certains cas, en laiton.

Tous ces matériaux sont résistants aux produits chimiques connus pour la protection des plantes et tous, à l'exception du laiton, résistent bien aux fertilisants liquides.

■ Le plastique se distingue pour sa grande précision, sa résistance à l'usure et ses excellents rapports prestations-prix.

■ L'acier inoxydable est le matériau idéal pour des charges mécaniques élevées.

■ Les buses en céramique sont en absolu les plus résistantes contre l'usure et sont donc conseillées pour leur durée de vie extrêmement longue et pour les bonnes prestations spécifiques sur la zone.



CERAMIC

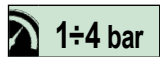

BD



SERIE BD "BASSA DERIVA"

Ugelli per uso a pieno campo senza induzione d'aria

Caratteristiche

- Realizzati in ceramica, con un contenuto di Allumina del 99%;
- Pressione consigliata da 1 a 4 bar
- Angolo di 80° o 110°;
- Indicato per erbicidi, insetticidi e fungicidi.

BD SERIES "LOW DRIFT"

Nozzles for full-field use without air induction

Features

- Made in ceramic with a 99% alumina content;
- Pressure recommended ranges from 1 to 4 bar;
- 80° or 110° angle;
- Suitable for herbicides, insecticides and fungicides.

SÉRIE BD « BASSE DÉRIVE »

Buses pour utilisation en plein champ sans induction d'air

Caractéristiques

- Réalisées en céramique avec teneur en alumine de 99%.
- Pression recommandée de 1 à 4 bars.
- Angle de 80° ou 110°
- Indiquées pour herbicides, insecticides et fongicides.

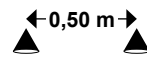

NOZZLE SPACING 0,50 m - Spraying Volume (L/Ha)

Part No.	Type	bar		VMD	l/min	Spraying Volume (L/Ha)																			
		1	2			psi	4	5	6	7	8	9	10	12	14	16	18	20	25						
8259475 8259360	BD 80 - 01	1	15	F	0,22	66	53	44	38	33	29	26	22	19	17	15	13	11							
		2	30	F	0,32	96	77	64	55	48	43	38	32	27	24	21	19	15							
	BD 110 - 01	3	45	F	0,41	123	98	82	70	62	55	49	41	35	31	27	25	20							
		4	60	F	0,46	138	110	92	79	69	61	55	46	39	35	31	28	22							
8259476 8259361	BD 80 - 015	1	15	M	0,36	108	86	72	62	54	48	43	36	31	27	24	22	17							
		2	30	F	0,50	150	120	100	86	75	67	60	50	43	38	33	30	24							
	BD 110 - 015	3	45	F	0,61	183	146	122	105	92	81	73	61	52	46	41	37	29							
		4	60	F	0,70	210	168	140	120	105	93	84	70	60	53	47	42	34							
8259477 8259362	BD 80 - 02	1	15	M	0,48	144	115	96	82	72	64	58	48	41	36	32	29	23							
		2	30	F	0,66	198	158	132	113	99	88	79	66	57	50	44	40	32							
	BD 110 - 02	3	45	F	0,82	246	197	164	141	123	109	98	82	70	62	55	49	39							
		4	60	F	0,95	285	228	190	163	143	127	114	95	81	71	63	57	46							
8259478 8259363	BD 80 - 03	1	15	M	0,72	216	173	144	123	108	96	86	72	62	54	48	43	35							
		2	30	M	1,00	300	240	200	171	150	133	120	100	86	75	67	60	48							
	BD 110 - 03	3	45	F	1,25	375	300	250	214	188	167	150	125	107	94	83	75	60							
		4	60	F	1,43	429	343	286	245	215	191	172	143	123	107	95	86	69							
8259479 8259364	BD 80 - 04	1	15	M	0,96	288	230	192	165	144	128	115	96	82	72	64	58	46							
		2	30	M	1,32	396	317	264	226	198	176	158	132	113	99	88	79	63							
	BD 110 - 04	3	45	F	1,62	486	389	324	278	243	216	194	162	139	122	108	97	78							
		4	60	F	1,89	567	454	378	324	284	252	227	189	162	142	126	113	91							
8259480 8259365	BD 80 - 05	1	15	G	1,20	360	288	240	206	180	160	144	120	103	90	80	72	58							
		2	30	M	1,67	501	401	334	286	251	223	200	167	143	125	111	100	80							
	BD 110 - 05	3	45	F	2,07	621	497	414	355	311	276	248	207	177	155	138	124	99							
		4	60	F	2,39	717	574	478	410	359	319	287	239	205	179	159	143	115							
8259481 8259366	BD 80 - 06	1	15	G	1,44	432	346	288	247	216	192	173	144	123	108	96	86	69							
		2	30	M	2,02	606	485	404	346	303	269	242	202	173	152	135	121	97							
	BD 110 - 06	3	45	F	2,49	747	598	498	427	374	332	299	249	213	187	166	149	120							
		4	60	F	2,86	858	686	572	490	429	381	343	286	245	215	191	172	137							
8259482 8259367	BD 80 - 08	1	15	G	1,88	564	451	376	322	282	251	226	188	161	141	125	113	90							
		2	30	M	2,77	831	665	554	475	416	369	332	277	237	208	185	166	133							
	BD 110 - 08	3	45	F	3,37	1011	809	674	578	506	449	404	337	289	253	225	202	162							
		4	60	F	3,86	1158	926	772	662	579	515	463	386	331	290	257	232	185							
8259483 8259368	BD 80 - 80005	1	15	F	0,14	42	34	28	24	21	19	17	14	12	11	9	8	7							
		2	30	F	0,18	54	43	36	31	27	24	22	18	15	14	12	11	9							
	BD 110 - 50005	3	45	F	0,21	63	50	42	36	32	28	25	21	18	16	14	13	10							
		4	60	F	0,23	69	55	46	39	35	31	28	23	20	17	15	14	11							

OPTIONALS



Pag. 277

Pag. 238-239

8253000	red
8253001	yellow
8253002	green
8253003	blue
8253041	white
8253042	orange
8253043	brown
8253048	black
8253118	grey
8253119	violet

AD



CERAMIC

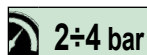

Generalitat de Catalunya
Departament d'Agricultura
Alimentació i Acció Rural



SERIE AD "ANTI DERIVA"

Ugelli per uso a pieno campo senza induzione d'aria

Caratteristiche

- Realizzati in ceramica, con un contenuto di Allumina del 99%;
- Pressione consigliata da 2 a 4 bar;
- Angolo di 110°;
- Indicato per erbicidi, insetticidi e fungicidi;
- La grandezza delle gocce riduce in parte la deriva.

AD SERIES "ANTI-DRIFT"

Nozzles for full-field use without air induction

Features

- Made in ceramic with a 99% alumina content;
- Pressure recommended ranges from 2 to 4 bar;
- 110° angle;
- Suitable for herbicides, insecticides and fungicides;
- The size of the drops partly reduces drift.

SÉRIE AD « ANTIDÉRIVE »

Buses pour utilisation en plein champ sans induction d'air

Caractéristiques

- Réalisées en céramique avec teneur en alumine de 99%.
- Pression recommandée de 2 à 4 bars.
- Angle de 110°.
- Indiquées pour herbicides, insecticides et fongicides.
- La grandeur des gouttes réduit en partie la dérive.



←0,50 m→
NOZZLE SPACING 0,50 m - SPRAYING VOLUME (l/ha)

Part No.	Type	bar	psi	VMD	l/min	4	5	6	7	8	9	10	12	14	16	18	20	25
						Km/h	Km/h	Km/h	Km/h	Km/h	Km/h	Km/h	Km/h	Km/h	Km/h	Km/h	Km/h	Km/h
8259354	AD 01	2	30	M	0,32	96	77	64	55	48	43	38	32	27	24	21	19	15
		3,1	45	F	0,41	123	98	82	70	62	55	49	41	35	31	27	25	20
		4,1	60	F	0,46	138	110	92	79	69	61	55	46	39	35	31	28	22
8259355	AD 015	2	30	M	0,50	150	120	100	86	75	67	60	50	43	38	33	30	24
		3,1	45	F	0,61	183	146	122	105	92	81	73	61	52	46	41	37	29
		4,1	60	F	0,70	210	168	140	120	105	93	84	70	60	53	47	42	34
8259356	AD 02	2	30	M	0,66	198	158	132	113	99	88	79	66	57	50	44	40	32
		3,1	45	M	0,82	246	197	164	141	123	109	98	82	70	62	55	49	39
		4,1	60	F	0,92	276	221	184	158	138	123	110	92	79	69	61	55	44
8259357	AD 03	2	30	M	1,00	300	240	200	171	150	133	120	100	86	75	67	60	48
		3,1	45	M	1,25	375	300	250	214	188	167	150	125	107	94	83	75	60
		4,1	60	M	1,43	429	343	286	245	215	191	172	143	123	107	95	86	69
8259358	AD 04	2	30	M	1,32	396	317	264	226	198	176	158	132	113	99	88	79	63
		3,1	45	M	1,62	486	389	324	278	243	216	194	162	139	122	108	97	78
		4,1	60	M	1,89	567	454	378	324	284	252	227	189	162	142	126	113	91
8259359	AD 05	2	30	G	1,67	501	401	334	286	251	223	200	167	143	125	111	100	80
		3,1	45	M	2,07	621	497	414	355	311	276	248	207	177	155	138	124	99
		4,1	60	M	2,39	717	574	478	410	359	319	287	239	205	179	159	143	115

OPTIONALS



Pag. 277

Pag. 238-239

8253000	red
8253001	yellow
8253002	green
8253003	blue
8253041	white
8253042	orange
8253043	brown
8253048	black
8253118	grey
8253119	violet

AZ



PLASTIC (POM)

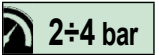

SERIE AZ "ANTI DERIVA" - Ugelli per uso a pieno campo senza induzione d'aria

Caratteristiche

- Realizzati in resina acetica;
- Pressione consigliata da 2 a 4 bar;
- Angolo di 80°-110°;
- È possibile lavorare con la barra del nebulizzatore più vicina al punto da irrorare;
- Indicato per erbicidi, insetticidi e fungicidi;
- La grandezza delle gocce ne riduce in parte la deriva.

AZ SERIES "ANTI-DRIFT" - Nozzles for full-field use without air induction

Features

- Made in acetal resin;
- Pressure recommended ranges from 2 to 4 bar;
- 80° - 110° angle;
- It is possible to work with the mist blower boom closer to the point to spray;
- Suitable for herbicides, insecticides and fungicides;
- The size of the drops partly reduces its drift.

SÉRIE AZ « ANTIDÉRIVE » - Buses pour utilisation en plein champ sans induction d'air

Caractéristiques

- Réalisées en résine d'acétal.
- Pression recommandée de 2 à 4 bar.
- Angle de 80°-110°.
- Il est possible d'opérer avec la barre du pulvérisateur plus près du point à traiter.
- Indiquées pour herbicides, insecticides et fongicides.
- La grandeur des gouttes en réduit en partie la dérive.



SPRAYING VOLUME (l/ha)

Part No.	Part No.	Type	SPRAYING VOLUME (l/ha)															
			bar	psi	l/min	4 Km/h	5 Km/h	6 Km/h	7 Km/h	8 Km/h	9 Km/h	10 Km/h	12 Km/h	14 Km/h	16 Km/h	18 Km/h	20 Km/h	25 Km/h
8261041 8261042	8259534 8259541	AZ 110-01 AZ 80-01	2	30	0,32	96	76,8	64	54,9	48	38,4	32	24	21,3	19,2	15,4	12,8	11
			3	43	0,39	117	93,6	78	66,9	58,5	46,8	39	29,3	26	23,4	18,7	15,6	13,4
			3,5	5,1	0,42	126	101	84	72	63	50,4	42	31,5	28	25,2	20,2	16,8	14,4
			4	58	0,45	135	108	90	77,1	67,5	54	45	33,8	30	27	21,6	18	15,4
8261043 8261044	8259535 8259542	AZ 110-015 AZ 80-015	2	30	0,48	144	115	96	82,3	72	57,6	48	36	32	28,8	23	19,2	16,5
			2,5	36	0,54	162	130	108	92,6	81	64,8	54	40,5	36	32,4	25,9	21,6	18,5
			3	43	0,59	177	142	118	101	88,5	70,8	59	44,3	39,3	35,4	28,3	23,6	20,2
			3,5	5,1	0,64	192	154	128	110	96	76,8	64	48	42,7	38,4	30,7	25,6	21,9
8261045 8261046	8259536 8259543	AZ 110-02 AZ 80-02	2	30	0,65	195	156	130	111	97,5	78	65	48,8	43,3	39	31,2	26	22,3
			2,5	36	0,72	216	173	144	123	108	86,4	72	54	48	43,2	34,6	28,8	24,7
			3	43	0,79	237	190	158	135	119	94,8	79	59,3	52,7	47,4	37,9	31,6	27,1
			3,5	5,1	0,85	255	204	170	146	128	102	85	63,8	56,7	51	40,8	34	29,1
8261047 8261048	8259537 8259544	AZ 110-03 AZ 80-03	4	58	0,91	273	218	182	156	137	109	91	68,3	60,7	54,6	43,7	36,4	31,2
			2	30	0,96	288	230	192	165	144	115	96	72	64	57,6	46,1	38,4	32,9
			2,5	36	1,08	324	259	216	185	162	130	108	81	72	64,8	51,8	43,2	37
			3	43	1,18	354	283	236	202	177	142	118	88,5	78,7	70,8	56,6	47,2	40,5
8261049 8261050	8259538 8259545	AZ 110-04 AZ 80-04	3,5	5,1	1,27	381	305	254	218	191	152	127	95,3	84,7	76,2	61	50,8	43,5
			4	58	1,36	408	326	272	233	204	163	136	102	90,7	81,6	65,3	54,4	46,6
			2	30	1,29	387	310	258	221	194	155	129	96,8	86	77,4	61,9	51,6	44,2
			2,5	36	1,44	432	346	288	247	216	173	144	108	96	86,4	69,1	57,6	49,4
8261051 8261052	8259539 8259546	AZ 110-05 AZ 80-05	3	43	1,58	474	379	316	271	237	190	158	119	105	94,8	75,8	63,2	54,2
			3,5	5,1	1,71	513	410	342	293	257	205	171	128	114	103	82,1	68,4	58,6
			4	58	1,82	546	437	364	312	273	218	182	137	121	109	87,4	72,8	62,4
			2	30	1,61	483	386	322	276	242	193	161	121	107	96,6	77,3	64,4	55,2
8261053 8261054	8259540 8259547	AZ 110-06 AZ 80-06	2,5	36	1,8	540	432	360	309	270	216	180	135	120	108	86,4	72	61,7
			3	43	1,97	591	473	394	338	296	236	197	148	131	118	94,6	78,8	67,5
			3,5	5,1	2,13	639	511	426	365	320	256	213	160	142	128	102	85,2	73
			4	58	2,27	681	545	454	389	341	272	227	170	151	136	109	90,8	77,8
8253000	red	AZ 110-06 AZ 80-06	2	30	1,94	582	466	388	333	291	233	194	146	129	116	93,1	77,6	66,5
			2,5	36	2,16	648	518	432	370	324	259	216	162	144	130	104	86,4	74,1
			3	43	2,37	711	569	474	406	356	284	237	178	158	142	114	94,8	81,3
			3,5	5,1	2,56	768	614	512	439	384	307	256	192	171	154	123	102	87,8
8253001	yellow	AZ 110-06 AZ 80-06	4	58	2,74	822	658	548	470	411	329	274	206	183	164	132	110	93,9

OPTIONALS



Pag. 277

Pag. 238-239

8253000	red
8253001	yellow
8253002	green
8253003	blue
8253041	white
8253042	orange
8253043	brown
8253048	black
8253118	grey
8253119	violet

ADGA



CERAMIC

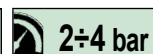

SERIE ADGA "ANTI DERIVA" AD ANGOLO GRANDE - Ugelli per uso a pieno campo senza induzione d'aria

Caratteristiche

- Realizzati in ceramica, con un contenuto di Allumina del 99%;
- Pressione consigliata da 2 a 4 bar;
- Angolo di 120°;
- È possibile lavorare con la barra del nebulizzatore più vicina al punto da irrorare;
- Indicato per erbicidi, insetticidi e fungicidi;
- La grandezza delle gocce ne riduce in parte la deriva.

ADGA SERIES WIDE ANGLE "ANTI-DRIFT" - Nozzles for full-field use without air induction

Features

- Made in ceramic with a 99% alumina content;
- Pressure recommended ranges from 2 to 4 bar;
- 120° angle;
- It is possible to work with the mist blower boom closer to the point to spray;
- Suitable for herbicides, insecticides and fungicides;
- The size of the drops partly reduces its drift.

SÉRIE ADGA « ANTIDÉRIVE » À GRAND ANGLE - Buses pour utilisation en plein champ sans induction d'air

Caractéristiques

- Réalisées en céramique avec teneur en alumine de 99%.
- Pression recommandée de 2 à 4 bars.
- Angle de 120°.
- Il est possible d'opérer avec la barre du pulvérisateur plus près du point à traiter.
- Indiquées pour herbicides, insecticides et fongicides.
- La grandeur des gouttes en réduit en partie la dérive.



← 0,50 m →
NOZZLE SPACING 0,50 m - SPRAYING VOLUME (l/ha)

Part No.	Type	bar	psi	VMD	l/min	NOZZLE SPACING 0,50 m - SPRAYING VOLUME (l/ha)												
						4 Km/h	5 Km/h	6 Km/h	7 Km/h	8 Km/h	9 Km/h	10 Km/h	12 Km/h	14 Km/h	16 Km/h	18 Km/h	20 Km/h	25 Km/h
8259435	ADGA 01	1	15	M	0,22	66	53	44	38	33	29	26	22	19	17	15	13	11
		2	30	F	0,32	96	77	64	55	48	43	38	32	27	24	21	19	15
		3,1	45	F	0,41	123	98	82	70	62	55	49	41	35	31	27	25	20
		4,1	60	F	0,46	138	110	92	79	69	61	55	46	39	35	31	28	22
8259436	ADGA 015	1	15	M	0,36	108	86	72	62	54	48	43	36	31	27	24	22	17
		2	30	F	0,50	150	120	100	86	75	67	60	50	43	38	33	30	24
		3,1	45	F	0,61	183	146	122	105	92	81	73	61	52	46	41	37	29
8259437	ADGA 02	1	15	M	0,48	144	115	96	82	72	64	58	48	41	36	32	29	23
		2	30	M	0,66	198	158	132	113	99	88	79	66	57	50	44	40	32
		3,1	45	F	0,82	246	197	164	141	123	109	98	82	70	62	55	49	39
8259438	ADGA 03	1	15	M	0,72	216	173	144	123	108	96	86	72	62	54	48	43	35
		2	30	M	1,00	300	240	200	171	150	133	120	100	86	75	67	60	48
		3,1	45	M	1,25	375	300	250	214	188	167	150	125	107	94	83	75	60
8259439	ADGA 04	1	15	M	0,96	288	230	192	165	144	128	115	96	82	72	64	58	46
		2	30	M	1,32	396	317	264	226	198	176	158	132	113	99	88	79	63
		3,1	45	M	1,62	486	389	324	278	243	216	194	162	139	122	108	97	78
		4,1	60	M	1,89	567	454	378	324	284	252	227	189	162	142	126	113	91

OPTIONALS



Pag. 277

Pag. 238-239

8253000	red
8253001	yellow
8253002	green
8253003	blue
8253041	white
8253042	orange
8253043	brown
8253048	black
8253118	grey
8253119	violet



CERAMIC



2÷7,5 bar

AD-IA



SERIE AD-IA "ANTI DERIVA" A INDUZIONE D'ARIA
Ugelli per uso a pieno campo a induzione d'aria

Caratteristiche

- Realizzati in ceramica, con un contenuto di Allumina del 99%;
- Pressione consigliata da 2 a 7.5 bar;
- Angolo di 80° - 110°;
- Dispone di un sistema Venturi a induzione d'aria nelle gocce, che consente a queste ultime di raggiungere grandi dimensioni, anche alle pressioni più elevate;
- Permette di lavorare con venti che raggiungono i 20 km/h.

AD-IA SERIES "AIR INDUCTION "ANTI-DRIFT"
Air induction nozzles for full-field use

Features

- Made in ceramic with a 99% alumina content;
- Pressure recommended ranges from 2 to 7.5 bar;
- 80° - 110° angle;
- It has a Venturi air induction system for the drops so they can become very big even at high pressures;
- It can be used even with 20 km/h winds.

SÉRIE AD-IA « ANTIDÉRIVE » À INDUCTION D'AIR - Buses pour utilisation en plein champ à induction d'air

Caractéristiques

- Réalisées en céramique avec teneur en alumine de 99%.
- Pression recommandée de 2 à 7,5 bars.
- Angle de 80° à 110°.
- Dispose d'un système Venturi à induction d'air dans les gouttes qui permet à celles-ci d'atteindre une grande taille y compris aux pressions les plus élevées.
- Permet d'opérer en présence de vents de 20 km/h.

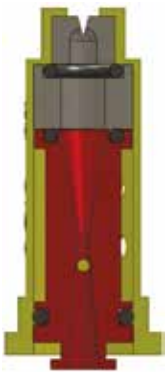

← 0,50 m →
NOZZLE SPACING 0,50 m - SPRAYING VOLUME (l/ha)

Part No.	Type	Pressure		VMD	l/min	Nozzle Spacing 0,50 m - Spraying Volume (l/ha)														
		bar	psi			4	5	6	7	8	9	10	12	14	16	18	20	25		
8259471 8259346	AD-IA 80 - 01 AD-IA 110 - 01	2	30	EG	0,38	114	91	76	65	57	51	46	38	33	29	25	23	18		
		3,4	50	MG	0,43	129	103	86	74	65	57	52	43	37	32	29	26	21		
		4,8	70	MG	0,50	150	120	100	86	75	67	60	50	43	38	33	30	24		
		6,2	90	G	0,56	168	134	112	96	84	75	67	56	48	42	37	34	27		
		7,6	110	G	0,62	186	149	124	106	93	83	74	62	53	47	41	37	30		
8259472 8259347	AD-IA 80 - 015 AD-IA 110 - 015	2	30	EG	0,48	144	115	96	82	72	64	58	48	41	36	32	29	23		
		3,4	50	MG	0,65	195	156	130	111	98	87	78	65	56	49	43	39	31		
		4,8	70	MG	0,77	231	185	154	132	116	103	92	77	66	58	51	46	37		
		6,2	90	MG	0,86	258	206	172	147	129	115	103	86	74	65	57	52	41		
		7,6	110	G	0,95	285	228	190	163	143	127	114	95	81	71	63	57	46		
8259473 8259348	AD-IA 80 - 02 AD-IA 110 - 02	2	30	EG	0,67	201	161	134	115	101	89	80	67	57	50	45	40	32		
		3,4	50	EG	0,89	267	214	178	153	134	119	107	89	76	67	59	53	43		
		4,8	70	MG	1,04	312	250	208	178	156	139	125	104	89	78	69	62	50		
		6,2	90	MG	1,18	354	283	236	202	177	157	142	118	101	89	79	71	57		
		7,6	110	G	1,29	387	310	258	221	194	172	155	129	111	97	86	77	62		
8259474 8259349	AD-IA 80 - 025 AD-IA 110 - 025	2	30	EG	0,83	249	199	166	142	125	111	100	83	71	62	55	50	40		
		3,4	50	EG	1,09	327	262	218	187	164	145	131	109	93	82	73	65	52		
		4,8	70	MG	1,29	387	310	258	221	194	172	155	129	111	97	86	77	62		
		6,2	90	MG	1,46	438	350	292	250	219	195	175	146	125	110	97	88	70		
		7,6	110	G	1,61	483	386	322	276	242	215	193	161	138	121	107	97	77		
8259350	AD-IA 110 - 03	2	30	EG	1,01	303	242	202	173	152	135	121	101	87	76	67	61	48		
		3,4	50	EG	1,33	399	319	266	228	200	177	160	133	114	100	89	80	64		
		4,8	70	MG	1,58	474	379	316	271	237	211	190	158	135	119	105	95	76		
		6,2	90	MG	1,80	540	432	360	309	270	240	216	180	154	135	120	108	86		
		7,6	110	MG	1,97	591	473	394	338	296	263	236	197	169	148	131	118	95		
8259351	AD-IA 110 - 04	2	30	EG	1,33	399	319	266	228	200	177	160	133	114	100	89	80	64		
		3,4	50	EG	1,73	519	415	346	297	260	231	208	173	148	130	115	104	83		
		4,8	70	MG	2,06	618	494	412	353	309	275	247	206	177	155	137	124	99		
		6,2	90	MG	2,32	696	557	464	398	348	309	278	232	199	174	155	139	111		
		7,6	110	MG	2,57	771	617	514	441	386	343	308	257	220	193	171	154	123		
8259352	AD-IA 110 - 05	2	30	EG	1,64	492	394	328	281	246	219	197	164	141	123	109	98	79		
		3,4	50	EG	2,14	642	514	428	367	321	285	257	214	183	161	143	128	103		
		4,8	70	EG	2,56	768	614	512	439	384	341	307	256	219	192	171	154	123		
		6,2	90	MG	2,87	861	689	574	492	431	383	344	287	246	215	191	172	138		
		7,6	110	MG	3,17	951	761	634	543	476	423	380	317	272	238	211	190	152		
8259353	AD-IA 110 - 06	2	30	EG	2,00	600	480	400	343	300	267	240	200	171	150	133	120	96		
		3,4	50	EG	2,57	771	617	514	441	386	343	308	257	220	193	171	154	123		
		4,8	70	EG	3,03	909	727	606	519	455	404	364	303	260	227	202	182	145		
		6,2	90	MG	3,53	1059	847	706	605	530	471	424	353	303	265	235	212	169		
		7,6	110	MG	3,85	1155	924	770	660	578	513	462	385	330	289	257	231	185		

OPTIONALS



Pag. 277



Pag. 238-239

8253028	red
8253029	yellow
8253030	green
8253031	blue
8253069	orange
8253070	brown
8253071	black
8253126	white
8253127	light blue
8253128	violet

AD-IA/D



CERAMIC



2÷7,5 bar

SERIE AD-IA/D "ANTI DERIVA" A INDUZIONE D'ARIA - DOPPIO - Ugelli per uso a pieno campo a induzione d'aria

Caratteristiche

- Realizzati in ceramica, con un contenuto di Allumina del 99%;
- Pressione consigliata da 2 a 7.5 bar;
- Consente una migliore penetrazione nel punto da irrorare;
- Angolo di 110° di apertura e 40° tra i ventagli;
- Permette di lavorare con venti che raggiungono i 20 km/h.

AD-IA/D SERIES DOUBLE "AIR INDUCTION "ANTI-DRIFT" - Air induction nozzles for full-field use

Features

- Made in ceramic with a 99% alumina content;
- Pressure recommended ranges from 2 to 7.5 bar;
- It gives a better coverage in the point to spray;
- 110° opening angle and 40° between fans;
- It can be used even with 20 km/h winds.

SÉRIE AD-IA/D « ANTIDÉRIVE » À INDUCTION D'AIR - DOUBLE - Buses pour utilisation en plein champ à induction d'air

Caractéristiques

- Réalisées en céramique avec teneur en alumine de 99%.
- Pression recommandée de 2 à 7,5 bars.
- Permet une meilleure pénétration sur le point à traiter.
- Angle d'ouverture de 110° et de 40° entre les éventails.
- Permet d'opérer en présence de vents de 20 km/h.



NOZZLE SPACING 0,50 m - SPRAYING VOLUME (l/ha)

Part No.	Type	Pressure		VMD	l/min	Nozzle Spacing (m)																
		bar	psi			4	5	6	7	8	9	10	12	14	16	18	20	25				
8259410	AD-IA 01.D	2	30	EG	0,38	114	91	76	65	57	51	46	38	33	29	25	23	18				
		3,4	50	MG	0,43	129	103	86	74	65	57	52	43	37	32	29	26	21				
		4,8	70	MG	0,50	150	120	100	86	75	67	60	50	43	38	33	30	24				
		6,2	90	G	0,56	168	134	112	96	84	75	67	56	48	42	37	34	27				
8259411	AD-IA 015.D	2	30	EG	0,48	144	115	96	82	72	64	58	48	41	36	32	29	23				
		3,4	50	MG	0,65	195	156	130	111	98	87	78	65	56	49	43	39	31				
		4,8	70	G	0,77	231	185	154	132	116	103	92	77	66	58	51	46	37				
		6,2	90	G	0,86	258	206	172	147	129	115	103	86	74	65	57	52	41				
8259412	AD-IA 02.D	2	30	EG	0,67	201	161	134	115	101	89	80	67	57	50	45	40	32				
		3,4	50	MG	0,89	267	214	178	153	134	119	107	89	76	67	59	53	43				
		4,8	70	G	1,04	312	250	208	178	156	139	125	104	89	78	69	62	50				
		6,2	90	G	1,18	354	283	236	202	177	157	142	118	101	89	79	71	57				
8259413	AD-IA 025.D	2	30	EG	0,83	249	199	166	142	125	111	100	83	71	62	55	50	40				
		3,4	50	MG	1,09	327	262	218	187	164	145	131	109	93	82	73	65	52				
		4,8	70	G	1,29	387	310	258	221	194	172	155	129	111	97	86	77	62				
		6,2	90	G	1,46	438	350	292	250	219	195	175	146	125	110	97	88	70				
8259414	AD-IA 03.D	2	30	EG	1,01	303	242	202	173	152	135	121	101	87	76	67	61	48				
		3,4	50	MG	1,33	399	319	266	228	200	177	160	133	114	100	89	80	64				
		4,8	70	G	1,58	474	379	316	271	237	211	190	158	135	119	105	95	76				
		6,2	90	G	1,80	540	432	360	309	270	240	216	180	154	135	120	108	86				
8259415	AD-IA 04.D	2	30	EG	1,33	399	319	266	228	200	177	160	133	114	100	89	80	64				
		3,4	50	MG	1,73	519	415	346	297	260	231	208	173	148	130	115	104	83				
		4,8	70	MG	2,06	618	494	412	353	309	275	247	206	177	155	137	124	99				
		6,2	90	G	2,32	696	557	464	398	348	309	278	232	199	174	155	139	111				
8259416	AD-IA 05.D	2	30	EG	1,64	492	394	328	281	246	219	197	164	141	123	109	98	79				
		3,4	50	MG	2,14	642	514	428	367	321	285	257	214	183	161	143	128	103				
		4,8	70	MG	2,56	768	614	512	439	384	341	307	256	219	192	171	154	123				
		6,2	90	G	2,87	861	689	574	492	431	383	344	287	246	215	191	172	138				
8259417	AD-IA 06.D	2	30	EG	2,04	612	490	408	350	306	272	245	204	175	153	136	122	98				
		3,4	50	MG	2,60	780	624	520	446	390	347	312	260	223	195	173	156	125				
		4,8	70	MG	3,08	924	739	616	528	462	411	370	308	264	231	205	185	148				
		6,2	90	MG	3,44	1032	826	688	590	516	459	413	344	295	258	229	206	165				

OPTIONALS



Pag. 277



Pag. 238-239

8253028	red
8253029	yellow
8253030	green
8253031	blue
8253069	orange
8253070	brown
8253071	black
8253126	white
8253127	light blue
8253128	violet

AS-IA



CERAMIC



UGELLO "VENTURI" AS-IA A VENTAGLIO -
DOPPIO ASIMMETRICO
Ugelli a induzione d'aria

Caratteristiche

- Tutti i modelli sono realizzati in ceramica con un contenuto di allumina del 99%, corpo in Resina acetaleica.
- Pressione di lavoro consigliata: da 40 a 110 psi (da 2 a 7,6 bar)
- Due getti a ventaglio con angoli da 110°.
- Orientamento asimmetrico dei due spruzzi, appositamente progettato per velocità di applicazione più elevate, garantendo una migliore copertura e penetrazione nel punto da irrorare
- Spruzzo inclinato in avanti con angolo di 30° per una migliore penetrazione in colture con grande massa fogliare e spruzzo inclinato indietro con angolo di 70° che garantisce la massima copertura delle coltivazioni
- Foro di uscita più ampio che ne evita l'intasamento;
- Ugello a induzione d'aria (sistema Venturi): produzione di gocce di grandi dimensioni piene d'aria. Questo sistema permette di ridurre la deriva e migliorare la copertura.
- Pre-orifizio estraibile per una pulizia più semplice e veloce

AS-IA ASYMMETRIC DOUBLE FLAT SPRAY
VENTURI NOZZLE
Air induction nozzles

Features

- Made in ceramic with a 99% Alumina cinted, body in Acetal resin;
- Recommended working pressure: 40 to 110 psi (2 to 7.6 bar)
- Two flat fan patterns with 110° angles.
- Asymmetric orientation of the two spray patterns, especially designed for higher application speeds, providing better coverage and penetration to target
- 30° forward tilted spray which provides better penetration in crops with dense foliage, while the backward tilted 70° spray ensures maximum crop coverage
- Large orifice minimizes clogging;
- Air induction spray nozzle (ventury system): sprays large droplets filled with air. This system reduces the drift and improves coverage.
- Removable pre-orifice for fast and easy cleaning

BUSE « VENTURI » AS-IA À ÉVENTAIL -
DOUBLE ASYMÉTRIQUE
Buses à induction d'air

Caractéristiques

- Tous les modèles sont réalisés en céramique avec un contenu d'alumine de 99%, corps en résine d'acétal.
- Pression de travail conseillée : de 40 à 110 psi (de 2 à 7,6 bar)
- Deux jets en éventail à angles de 110°.
- Orientation asymétrique des deux jets ; buse spécialement conçue pour des vitesses d'application supérieures, garantissant une meilleure couverture et une meilleure pénétration du point à traiter.
- Pulvérisation inclinée vers l'avant à un angle de 30° pour une meilleure pénétration sur les cultures à grande masse foliaire et pulvérisation inclinée vers l'arrière à un angle de 70° assurant la couverture maximale des cultures.
- Trou de sortie plus grand qui prévient l'obstruction.
- Buse à induction d'air (système Venturi) : production de gouttes de grandes dimensions pleines d'air. Ce système permet de réduire la dérive et d'améliorer la couverture.
- Pré-orifice extractible gage de nettoyage simple et rapide.



NOZZLE SPACING 0,50 m - SPRAYING VOLUME (l/ha)

Part No.	Type	bar	psi	l/min	NOZZLE SPACING 0,50 m					
					12 Km/h	14 Km/h	16 Km/h	18 Km/h	20 Km/h	25 Km/h
8259528	AS-IA 110-01	2	30	0,39	39	33	29	26	23	19
		3,4	50	0,44	44	38	33	29	26	21
		4,8	70	0,51	51	44	38	34	31	24
		6,2	90	0,58	58	50	44	39	35	28
		7,6	110	0,64	64	55	48	43	38	31
8259529	AS-IA 110-015	2	30	0,51	51	44	38	34	31	24
		3,4	50	0,65	65	56	49	43	39	31
		4,8	70	0,76	76	65	57	51	46	36
		6,2	90	0,87	87	75	65	58	52	42
8259530	AS-IA 110-02	2	30	0,66	66	57	50	44	40	32
		3,4	50	0,86	86	74	65	57	52	41
		4,8	70	1,00	100	86	75	67	60	48
		6,2	90	1,15	115	99	86	77	69	55
8259531	AS-IA 110-025	2	30	0,85	85	73	64	57	51	41
		3,4	50	1,07	107	92	80	71	64	51
		4,8	70	1,25	125	107	94	83	75	60
		6,2	90	1,45	145	124	109	97	87	70
8259532	AS-IA 110-03	2	30	1,01	101	87	76	67	61	48
		3,4	50	1,30	130	111	98	87	78	62
		4,8	70	1,53	153	131	115	102	92	73
		6,2	90	1,70	170	146	128	113	102	82
8259533	AS-IA 110-04	2	30	1,35	135	116	101	90	81	65
		3,4	50	1,75	175	150	131	117	105	84
		4,8	70	2,07	207	177	155	138	124	99
		6,2	90	2,35	235	201	176	157	141	113
		7,6	110	2,55	255	219	191	170	153	122

OPTIONALS



Pag. 277



Pag. 238-239

8253028	red
8253029	yellow
8253030	green
8253031	blue
8253069	orange
8253070	brown
8253071	black
8253126	white
8253127	light blue
8253128	violet

AD/T



CERAMIC



2,7÷8,9 bar

SERIE AD/T "ANTI DERIVA" - TRIPLO - Ugelli per uso a pieno campo senza induzione d'aria

Caratteristiche

- Inserto in ceramica con un contenuto di Allumina del 99%.
- L'azione a tre getti piatti offre migliore copertura e penetrazione, anche in caso di densa massa fogliare.
- Indicato per tutti i trattamenti applicati con barra da diserbo: erbicidi, fungicidi e insetticidi.
- Tre getti piatti a ventaglio con angolo di 110°. L'angolazione tra i tre getti è di 40° in avanti, indietro e al centro.
- Pressione consigliata: da 2,8 a 9 bar.

AD/T SERIES TRIPLE "ANTI-DRIFT" - Nozzles for full-field use without air induction

Features

- Ceramic insert with an alumina content of 99%
- Triple spray action provides better coverage and penetration even in dense foliage
- Recommended for all types of treatments with boom sprayers: herbicides, fungicides and insecticides
- Three 110° angle flat fan spray patterns. Angle between each spray pattern is 40° forward, back and in the center
- Wider options of recommended working pressures: from 40 to 130 psi

SÉRIE AD/T « ANTIDÉRIVE » - TRIPLE - Buses pour utilisation en plein champ sans induction d'air

Caractéristiques

- Insert en céramique avec teneur en alumine de 99 %.
- L'action à trois jets plats offre une meilleure couverture et pénétration, même en présence d'une masse foliaire dense.
- Indiquée pour tous les traitements appliqués avec barre de désherbage : herbicides, fongicides et insecticides.
- Trois jets plats en éventail à angle de 110°. L'angle entre les trois jets est de 40° vers l'avant, l'arrière et au centre.
- Pression conseillée : de 2,8 à 9 bars.

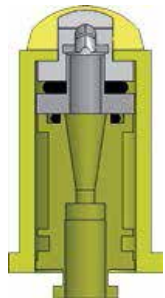

← 0,50 m →
NOZZLE SPACING 0,50 m - SPRAYING VOLUME (l/ha)

Part No.	Type	bar	psi	VMD	NOZZLE SPACING 0,50 m - SPRAYING VOLUME (l/ha)													
					l/min	4 Km/h	5 Km/h	6 Km/h	7 Km/h	8 Km/h	9 Km/h	10 Km/h	12 Km/h	15 Km/h	18 Km/h	20 Km/h	22 Km/h	25 Km/h
8259559	AD/T 110-02	2,8	40	F	0,76	228	182	152	130	114	101	91	76	61	51	46	41	36
		3,4	50	F	0,85	255	204	170	146	128	113	102	85	68	57	51	46	41
		4,1	60	F	0,92	276	221	184	158	138	123	110	92	74	61	55	50	44
		4,8	70	F	1,00	300	240	200	171	150	133	120	100	80	67	60	55	48
		6,2	90	MF	1,16	348	278	232	199	174	155	139	116	93	77	70	63	56
		7,6	110	MF	1,22	366	293	244	209	183	163	146	122	98	81	73	67	59
8259560	AD/T 110-025	2,8	40	F	0,98	294	235	196	168	147	131	118	98	78	65	59	53	47
		3,4	50	F	1,05	315	252	210	180	158	140	126	105	84	70	63	57	50
		4,1	60	F	1,14	342	274	228	195	171	152	137	114	91	76	68	62	55
		4,8	70	F	1,21	363	290	242	207	182	161	145	121	97	81	73	66	58
		6,2	90	F	1,36	408	326	272	233	204	181	163	136	109	91	82	74	65
		7,6	110	MF	1,48	444	355	296	254	222	197	178	148	118	99	89	81	71
8259561	AD/T 110-03	2,8	40	F	1,18	354	283	236	202	177	157	142	118	94	79	71	64	57
		3,4	50	F	1,3	390	312	260	223	195	173	156	130	104	87	78	71	62
		4,1	60	F	1,40	420	336	280	240	210	187	168	140	112	93	84	76	67
		4,8	70	F	1,50	450	360	300	257	225	200	180	150	120	100	90	82	72
		6,2	90	F	1,64	492	394	328	281	246	219	197	164	131	109	98	89	79
		7,6	110	MF	1,80	540	432	360	309	270	240	216	180	144	120	108	98	86
8259562	AD/T 110-04	2,8	40	M	1,58	474	379	316	271	237	211	190	158	126	105	95	86	76
		3,4	50	F	1,70	510	408	340	291	255	227	204	170	136	113	102	93	82
		4,1	60	F	1,84	552	442	368	315	276	245	221	184	147	123	110	100	88
		4,8	70	F	1,98	594	475	396	339	297	264	238	198	158	132	119	108	95
		6,2	90	F	2,14	642	514	428	367	321	285	257	214	171	143	128	117	103
		7,6	110	F	2,30	690	552	460	394	345	307	276	230	184	153	138	125	110
8259563	AD/T 110-05	2,8	40	M	1,97	591	473	394	338	296	263	236	197	158	131	118	107	95
		3,4	50	F	2,14	642	514	428	367	321	285	257	214	171	143	128	117	103
		4,1	60	F	2,30	690	552	460	394	345	307	276	230	184	153	138	125	110
		4,8	70	F	2,45	735	588	490	420	368	327	294	245	196	163	147	134	118
		6,2	90	F	2,70	810	648	540	463	405	360	324	270	216	180	162	147	130
		7,6	110	F	2,92	876	701	584	501	438	389	350	292	234	195	175	159	140
8259564	AD/T 110-06	2,8	40	M	3,12	936	749	624	535	468	416	374	312	250	208	187	170	150
		3,4	50	M	1,98	594	475	396	339	297	264	238	198	158	132	119	108	95
		3,4	50	M	2,62	786	629	524	449	393	349	314	262	210	175	157	143	126
		4,1	60	F	2,80	840	672	560	480	420	373	336	280	224	187	168	153	134
		4,8	70	F	3,00	900	720	600	514	450	400	360	300	240	200	180	164	144
		6,2	90	F	3,30	990	792	660	566	495	440	396	330	264	220	198	180	158
8259565	AD/T 110-08	2,8	40	M	3,60	1080	864	720	617	540	480	432	360	288	240	216	196	173
		3,4	50	M	3,10	930	744	620	531	465	413	372	310	248	207	186	169	149
		4,1	60	F	3,65	1095	876	730	626	548	487	438	365	292	243	219	199	175
		4,8	70	F	3,90	1170	936	780	669	585	520	468	390	312	260	234	213	187
		6,2	90	F	4,35	1305	1044	870	746	653	580	522	435	348	290	261	237	209
		7,6	110	F	4,76	1428	1142	952	816	714	635	571	476	381	317	286	260	228
8259566	AD/T 110-10	2,8	40	M	5,10	1530	1224	1020	874	765	680	612	510	408	340	306	278	245
		3,4	50	M	3,88	1164	931	776	665	582	517	466	388	310	259	233	212	186
		4,1	60	M	4,20	1260	1008	840	720	630	560	504	420	336	280	252	229	202
		4,8	70	M	4,56	1368	1094	912	782	684	608	547	456	365	304	274	249	219
		6,2	90	F	4,90	1470	1176	980	840	735	653	588	490	392	327	294	267	235
		7,6	110	F	5,40	1620	1296	1080	926	810	720	648	540	432	360	324	295	259

OPTIONALS



Pag. 277



Pag. 238-239

8253028	red
8253029	yellow
8253030	green
8253031	blue
8253069	orange
8253070	brown
8253071	black
8253126	white
8253127	light blue
8253128	violet

AD/D



CERAMIC



SERIE AD/D "ANTI DERIVA" - DOPPIO
Ugelli per uso a pieno campo senza induzione d'aria

Caratteristiche

- Realizzati in ceramica, con un contenuto di Allumina del 99%;
- Pressione consigliata da 2 a 4 bar;
- Consente una migliore copertura della superficie fogliare e una migliore penetrazione nel punto da irrorare (o in colture con grande massa fogliare);
- Angolo di 110° di apertura e 40° tra i ventagli;
- Indicato per erbicidi, insetticidi e fungicidi.

AD/D SERIES DOUBLE "ANTI-DRIFT"
Nozzles for full-field use without air induction

Features

- Made in ceramic with a 99% alumina content;
- Pressure recommended ranges from 2 to 4 bar;
- It gives a better coverage of leaf surface and better penetration in the point to spray (or on crops with a mass of leaves);
- 110° opening angle and 40° between fans;
- Suitable for herbicides, insecticides and fungicides.

SÉRIE AD/D « ANTIDÉRIVE » - DOUBLE
Buses pour utilisation en plein champ sans induction d'air

Caractéristiques

- Réalisées en céramique avec teneur en alumine de 99%.
- Pression recommandée de 2 à 4 bars.
- Permet une meilleure couverture de la surface foliaire et une meilleure pénétration dans le point à traiter (ou sur les cultures à grande masse foliaire).
- Angle d'ouverture de 110° et de 40° entre les éventails.
- Indiquées pour



← 0,50 m →
NOZZLE SPACING 0,50 m - SPRAYING VOLUME (l/ha)

Part No.	Type	VMD		l/min	SPRAYING VOLUME (l/ha)														
		bar	psi		4 Km/h	5 Km/h	6 Km/h	7 Km/h	8 Km/h	9 Km/h	10 Km/h	12 Km/h	14 Km/h	16 Km/h	18 Km/h	20 Km/h	25 Km/h		
8259440	AD 01.D	2	30	M	0,32	96	77	64	55	48	43	38	32	27	24	21	19	15	
		3,1	45	F	0,41	123	98	82	70	62	55	49	41	35	31	27	25	20	
		4,1	60	F	0,46	138	110	92	79	69	61	55	46	39	35	31	28	22	
8259441	AD 015.D	2	30	M	0,50	150	120	100	86	75	67	60	50	43	38	33	30	24	
		3,1	45	M	0,61	183	146	122	105	92	81	73	61	52	46	41	37	29	
		4,1	60	F	0,70	210	168	140	120	105	93	84	70	60	53	47	42	34	
8259442	AD 02.D	2	30	M	0,66	198	158	132	113	99	88	79	66	57	50	44	40	32	
		3,1	45	M	0,82	246	197	164	141	123	109	98	82	70	62	55	49	39	
		4,1	60	F	0,95	285	228	190	163	143	127	114	95	81	71	63	57	46	
8259443	AD 025.D	2	30	M	0,83	249	199	166	142	125	111	100	83	71	62	55	50	40	
		3,1	45	M	1,04	312	250	208	178	156	139	125	104	89	78	69	62	50	
		4,1	60	F	1,20	360	288	240	206	180	160	144	120	103	90	80	72	58	
8259444	AD 03.D	2	30	M	1,00	300	240	200	171	150	133	120	100	86	75	67	60	48	
		3,1	45	M	1,25	375	300	250	214	188	167	150	125	107	94	83	75	60	
		4,1	60	M	1,43	429	343	286	245	215	191	172	143	123	107	95	86	69	
8259445	AD 04.D	2	30	G	1,32	396	317	264	226	198	176	158	132	113	99	88	79	63	
		3,1	45	M	1,62	486	389	324	278	243	216	194	162	139	122	108	97	78	
		4,1	60	M	1,89	567	454	378	324	284	252	227	189	162	142	126	113	91	
8259446	AD 05.D	2	30	G	1,67	501	401	334	286	251	223	200	167	143	125	111	100	80	
		3,1	45	M	2,07	621	497	414	355	311	276	248	207	177	155	138	124	99	
		4,1	60	M	2,39	717	574	478	410	359	319	287	239	205	179	159	143	115	
8259447	AD 06.D	2	30	G	2,02	606	485	404	346	303	269	242	202	173	152	135	121	97	
		3,1	45	M	2,49	747	598	498	427	374	332	299	249	213	187	166	149	120	
		4,1	60	M	2,86	858	686	572	490	429	381	343	286	245	215	191	172	137	
8259448	AD 08.D	2	30	G	2,77	831	665	554	475	416	369	332	277	237	208	185	166	133	
		3,1	45	G	3,37	1011	809	674	578	506	449	404	337	289	253	225	202	162	
		4,1	60	M	3,86	1158	926	772	662	579	515	463	386	331	290	257	232	185	

OPTIONALS



Pag. 277



Pag. 238-239

8253028	red
8253029	yellow
8253030	green
8253031	blue
8253069	orange
8253070	brown
8253071	black
8253126	white
8253127	light blue
8253128	violet

ST-IA



CERAMIC



2÷6,5 bar

SERIE ST-IA "SUPER TURBO" A INDUZIONE D'ARIA - Ugelli per uso a pieno campo a induzione d'aria

Caratteristiche

- Realizzati in ceramica, con un contenuto di Allumina del 99%;
- Dotati di un grande angolo di apertura (140°), che permette di lavorare con la barra del nebulizzatore più vicina al punto da irrorare;
- Ventaglio con un'inclinazione di 30° che consente una migliore penetrazione nel punto da irrorare (o in colture con grande massa fogliare);
- Foro di uscita più ampio che ne facilita la pulizia e ne evita l'intasamento;
- Permette di lavorare con venti che raggiungono i 20 km/h;
- Pressione consigliata da 2 a 6.5 bar;
- Dispone di un sistema Venturi a induzione d'aria nelle gocce, che consente a queste ultime di raggiungere grandi dimensioni, anche a pressioni elevate.

ST-IA SERIES AIR INDUCTION "SUPER TURBO"
Air induction nozzles for full-field use

Features

- Made in ceramic with a 99% alumina content;
- These nozzles have a wide opening angle (140°) which means the mist blower boom can be used closer to the point to spray;
- 30° fan angle ensuring better penetration in the point to spray (or on crops with a mass of leaves);
- A bigger outlet hole for easier cleaning and no clogging.
- It can be used even with 20 km/h winds
- Pressure recommended ranges from 2 to 6.5 bar
- It has a Venturi air induction system for the drops so they can become very big even at high pressures.

SÉRIE ST-IA « SUPER TURBO » À INDUCTION D'AIR - Buses pour utilisation en plein champ à induction d'air

Caractéristiques

- Réalisées en céramique avec teneur en alumine de 99%.
- Dotées d'un grand angle d'ouverture (140°) qui permet d'opérer avec la barre du pulvérisateur plus près du point à traiter.
- Éventail à inclinaison de 30° qui permet une meilleure pénétration dans le point à traiter (ou sur les cultures à grande masse foliaire).
- Trou de sortie plus grand qui facilite le nettoyage et en prévient l'obstruction.
- Permet d'opérer en présence de vents de 20 km/h.
- Pression recommandée de 2 à 6,5 bars.
- Dispose d'un système Venturi à induction d'air dans les gouttes qui permet à celles-ci d'atteindre une grande taille y compris à haute pression.



← 0,50 m →
NOZZLE SPACING 0,50 m - SPRAYING VOLUME (l/ha)

Part No.	Type	bar		VMD	l/min	NOZZLE SPACING 0,50 m - SPRAYING VOLUME (l/ha)												
		2	3,4			4	5	6	7	8	9	10	12	14	16	18	20	25
8259404	ST-IA 01	2	30	EG	0,38	114	91	76	65	57	51	46	38	33	29	25	23	18
		3,4	50	EG	0,43	129	103	86	74	65	57	52	43	37	32	29	26	21
		4,8	70	MG	0,50	150	120	100	86	75	67	60	50	43	38	33	30	24
		6,2	90	MG	0,56	168	134	112	96	84	75	67	56	48	42	37	34	27
8259405	ST-IA 015	2	30	EG	0,48	144	115	96	82	72	64	58	48	41	36	32	29	23
		3,4	50	EG	0,65	195	156	130	111	98	87	78	65	56	49	43	39	31
		4,8	70	MG	0,77	231	185	154	132	116	103	92	77	66	58	51	46	37
		6,2	90	MG	0,86	258	206	172	147	129	115	103	86	74	65	57	52	41
8259406	ST-IA 02	2	30	EG	0,67	201	161	134	115	101	89	80	67	57	50	45	40	32
		3,4	50	EG	0,89	267	214	178	153	134	119	107	89	76	67	59	53	43
		4,8	70	EG	1,04	312	250	208	178	156	139	125	104	89	78	69	62	50
		6,2	90	EG	1,18	354	283	236	202	177	157	142	118	101	89	79	71	57
8259407	ST-IA 025	2	30	EG	0,83	249	199	166	142	125	111	100	83	71	62	55	50	40
		3,4	50	EG	1,09	327	262	218	187	164	145	131	109	93	82	73	65	52
		4,8	70	EG	1,29	387	310	258	221	194	172	155	129	111	97	86	77	62
		6,2	90	EG	1,46	438	350	292	250	219	195	175	146	125	110	97	88	70
8259408	ST-IA 03	2	30	EG	1,01	303	242	202	173	152	135	121	101	87	76	67	61	48
		3,4	50	EG	1,33	399	319	266	228	200	177	160	133	114	100	89	80	64
		4,8	70	EG	1,58	474	379	316	271	237	211	190	158	135	119	105	95	76
		6,2	90	EG	1,80	540	432	360	309	270	240	216	180	154	135	120	108	86
8259409	ST-IA 04	2	30	EG	1,33	399	319	266	228	200	177	160	133	114	100	89	80	64
		3,4	50	EG	1,73	519	415	346	297	260	231	208	173	148	130	115	104	83
		4,8	70	EG	2,06	618	494	412	353	309	275	247	206	177	155	137	124	99
		6,2	90	EG	2,32	696	557	464	398	348	309	278	232	199	174	155	139	111

OPTIONALS



Pag. 277

Pag. 238-239

8253028	red
8253029	yellow
8253030	green
8253031	blue
8253069	orange
8253070	brown
8253071	black
8253126	white
8253127	light blue
8253128	violet

ST



CERAMIC



SERIE ST "SUPER TURBO" - Ugelli per uso a pieno campo senza induzione d'aria

Caratteristiche

- Realizzati in ceramica, con un contenuto di Allumina del 99%;
- Dotati di un grande angolo di apertura (max 135°), che permette di lavorare con la barra del nebulizzatore più vicina al punto da irrorare;
- Ventaglio con un'inclinazione di 30° in avanti, che fornisce una migliore penetrazione nel punto da irrorare (o in colture con grande massa fogliare);
- Foro di uscita più ampio che ne facilita la pulizia e ne evita l'intasamento;
- Consente una buona copertura del punto da irrorare;
- Pressione consigliata 1,5 a 6 bar.

ST SERIES "SUPER TURBO" - Nozzles for full-field use without air induction

Features

- Made in ceramic with a 99% alumina content;
- These nozzles have a wide opening angle (max 135°) which means the mist blower boom can be used closer to the point to spray;
- 30° forward fan angle ensuring better penetration in the point to spray (or on crops with a mass of leaves);
- A bigger outlet hole for easier cleaning and no clogging;
- It provides good coverage of the point sprayed;
- Pressure recommended ranges from 1,5 to 6 bar.

SÉRIE ST « SUPER TURBO » - Buses pour utilisation en plein champ sans induction d'air

Caractéristiques

- Réalisées en céramique avec teneur en alumine de 99%.
- Dotées d'un grand angle d'ouverture (max. 135°) qui permet d'opérer avec la barre du pulvérisateur plus près du point à traiter.
- Éventail à inclinaison de 30° vers l'avant qui assure une meilleure pénétration dans le point à traiter (ou sur les cultures à grande masse foliaire).
- Trou de sortie plus grand qui facilite le nettoyage et en prévient l'obstruction.
- Permet une bonne couverture du point à traiter.
- Pression recommandée de 1,5 à 6 bars.

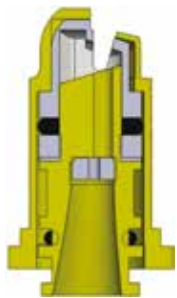

NOZZLE SPACING 0,50 m - SPRAYING VOLUME (l/ha)

Part No.	Type	bar		VMD	l/min	NOZZLE SPACING 0,50 m - SPRAYING VOLUME (l/ha)														
		psi	psi			4	5	6	7	8	9	10	12	14	16	18	20	25		
8259449	ST 01	1.4	20	G	0.25	75	60	50	43	38	33	30	25	21	19	17	15	12		
		2	30	G	0.32	96	77	64	55	48	43	38	32	27	24	21	19	15		
		3.1	45	M	0.41	123	98	82	70	62	55	49	41	35	31	27	25	20		
		4.1	60	M	0.46	138	110	92	79	69	61	55	46	39	35	31	28	22		
		5	75	M	0.53	159	127	106	91	80	71	64	53	45	40	35	32	25		
8259450	ST 015	1.4	20	G	0.40	120	96	80	69	60	53	48	40	34	30	27	24	19		
		2	30	G	0.50	150	120	100	86	75	67	60	50	43	38	33	30	24		
		3.1	45	G	0.61	183	146	122	105	92	81	73	61	52	46	41	37	29		
		4.1	60	M	0.70	210	168	140	120	105	93	84	70	60	53	47	42	34		
		5	75	M	0.80	240	192	160	137	120	107	96	80	69	60	53	48	38		
8259451	ST 02	1.4	20	MG	0.56	168	134	112	96	84	75	67	56	48	42	37	34	27		
		2	30	MG	0.66	198	158	132	113	99	88	79	66	57	50	44	40	32		
		3.1	45	G	0.82	246	197	164	141	123	109	98	82	70	62	55	49	39		
		4.1	60	G	0.95	285	228	190	163	143	127	114	95	81	71	63	57	46		
		5	75	M	1.05	315	252	210	180	158	140	126	105	90	79	70	63	50		
8259452	ST 025	1.4	20	MG	0.70	210	168	140	120	105	93	84	70	60	53	47	42	34		
		2	30	MG	0.83	249	199	166	142	125	111	100	83	71	62	55	50	40		
		3.1	45	G	1.04	312	250	208	178	156	139	125	104	89	78	69	62	50		
		4.1	60	G	1.20	360	288	240	206	180	160	144	120	103	90	80	72	58		
		5	75	G	1.31	393	314	262	225	197	175	157	131	112	98	87	79	63		
8259453	ST 03	1.4	20	MG	0.82	246	197	164	141	123	109	98	82	70	62	55	49	39		
		2	30	MG	1.00	300	240	200	171	150	133	120	100	86	75	67	60	48		
		3.1	45	G	1.25	375	300	250	214	188	167	150	125	107	94	83	75	60		
		4.1	60	G	1.43	429	343	286	245	215	191	172	143	123	107	95	86	69		
		5	75	G	1.55	465	372	310	266	233	207	186	155	133	116	103	93	74		
8259454	ST 04	1.4	20	MG	1.10	330	264	220	189	165	147	132	110	94	83	73	66	53		
		2	30	MG	1.32	396	317	264	226	198	176	158	132	113	99	88	79	63		
		3.1	45	G	1.62	486	389	324	278	243	216	194	162	139	122	108	97	78		
		4.1	60	G	1.89	567	454	378	324	284	252	227	189	162	142	126	113	91		
		5	75	G	2.07	621	497	414	355	311	276	248	207	177	155	138	124	99		
8259455	ST 05	1.4	20	MG	1.38	414	331	276	237	207	184	166	138	118	104	92	83	66		
		2	30	MG	1.67	501	401	334	286	251	223	200	167	143	125	111	100	80		
		3.1	45	G	2.07	621	497	414	355	311	276	248	207	177	155	138	124	99		
		4.1	60	G	2.39	717	574	478	410	359	319	287	239	205	179	159	143	115		
		5	75	G	2.58	774	619	516	442	387	344	310	258	221	194	172	155	124		
8259456	ST 06	1.4	20	MG	1.67	501	401	334	286	251	223	200	167	143	125	111	100	80		
		2	30	MG	2.02	606	485	404	346	303	269	242	202	173	152	135	121	97		
		3.1	45	G	2.49	747	598	498	427	374	332	299	249	213	187	166	149	120		
		4.1	60	G	2.86	858	686	572	490	429	381	343	286	245	215	191	172	137		
		5	75	G	3.10	930	744	620	531	465	413	372	310	266	233	207	186	149		
		6.2	90	G	3.39	1017	814	678	581	509	452	407	339	291	254	226	203	163		

OPTIONALS



Pag. 277



Pag. 238-239

8253028	red
8253029	yellow
8253030	green
8253031	blue
8253069	orange
8253070	brown
8253071	black
8253126	white
8253127	light blue
8253128	violet

MGA



CERAMIC



4,8=20,7 bar

SERIE MGA - Ugelli per uso a pieno campo senza induzione d'aria

Caratteristiche

- Realizzati in ceramica, con un contenuto di Allumina del 99%;
- Pressione consigliata 4,8 a 20,7 bar.
- Angolo di 90°;
- Riduce le gocce rendendole estremamente fini e formando una copertura molto uniforme;
- Consente una migliore copertura della superficie fogliare e una migliore penetrazione;
- Indicato per l'applicazione di fungicidi e insetticidi sistemici;

MGA SERIES - Nozzles for full-field use without air induction

Features

- Made in ceramic with a 99% alumina content;
- Pressure recommended ranges from 4.8 to 20.7 bar.
- 90° angle;
- Reduces the drops so they are extremely fine to give a really uniform coverage;
- It gives a better coverage of leaf surface and better penetration;
- Suitable for spraying systemic fungicides and insecticides;

SÉRIE MGA - Buses pour utilisation en plein champ sans induction d'air

Caractéristiques

- Réalisées en céramique avec teneur en alumine de 99%.
- Pression recommandée de 4,8 à 20,7 bars.
- Angle de 90°.
- Réduit la dimension des gouttes en les rendant extrêmement fines et forme une couverture très homogène.
- Permet une meilleure couverture de la surface foliaire et une meilleure pénétration.
- Indiquées pour l'application de fongicides et d'insecticides systémiques.

90°



← 0,50 m →
NOZZLE SPACING 0,50 m - SPRAYING VOLUME (l/ha)

Part No.	Type	bar		VMD	l/min	NOZZLE SPACING 0,50 m - SPRAYING VOLUME (l/ha)												
		psi	MF			4 Km/h	5 Km/h	6 Km/h	7 Km/h	8 Km/h	9 Km/h	10 Km/h	12 Km/h	14 Km/h	16 Km/h	18 Km/h	20 Km/h	25 Km/h
8259484	MGA 900067	4,8	70	MF	0,33	99	79	66	57	50	44	40	33	28	25	22	20	16
		6,9	100	MF	0,39	117	94	78	67	59	52	47	39	33	29	26	23	19
		10,4	150	MF	0,46	138	110	92	79	69	61	55	46	39	35	31	28	22
		13,8	200	MF	0,56	168	134	112	96	84	75	67	56	48	42	37	34	27
8259485	MGA 9001	4,8	70	MF	0,50	150	120	100	86	75	67	60	50	43	38	33	30	24
		6,9	100	MF	0,59	177	142	118	101	89	79	71	59	51	44	39	35	28
		10,4	150	MF	0,68	204	163	136	117	102	91	82	68	58	51	45	41	33
		13,8	200	MF	0,82	246	197	164	141	123	109	98	82	70	62	55	49	39
8259486	MGA 90015	4,8	70	MF	0,75	225	180	150	129	113	100	90	75	64	56	50	45	36
		6,9	100	MF	0,90	270	216	180	154	135	120	108	90	77	68	60	54	43
		10,4	150	MF	1,05	315	252	210	180	158	140	126	105	90	79	70	63	50
		13,8	200	MF	1,25	375	300	250	214	188	167	150	125	107	94	83	75	60
8259487	MGA 9002	4,8	70	MF	1,00	300	240	200	171	150	133	120	100	86	75	67	60	48
		6,9	100	MF	1,20	360	288	240	206	180	160	144	120	103	90	80	72	58
		10,4	150	MF	1,42	426	341	284	243	213	189	170	142	122	107	95	85	68
		13,8	200	MF	1,65	495	396	330	283	248	220	198	165	141	124	110	99	79
8259488	MGA 90025	4,8	70	MF	1,25	375	300	250	214	188	167	150	125	107	94	83	75	60
		6,9	100	MF	1,50	450	360	300	257	225	200	180	150	129	113	100	90	72
		10,4	150	MF	1,81	543	434	362	310	272	241	217	181	155	136	121	109	87
		13,8	200	MF	2,07	621	497	414	355	311	276	248	207	177	155	138	124	99
8259489	MGA 9003	4,8	70	MF	1,50	450	360	300	257	225	200	180	150	129	113	100	90	72
		6,9	100	MF	1,80	540	432	360	309	270	240	216	180	154	135	120	108	86
		10,4	150	MF	2,20	660	528	440	377	330	293	264	220	189	165	147	132	106
		13,8	200	MF	2,50	750	600	500	429	375	333	300	250	214	188	167	150	120
8259490	MGA 9004	4,8	70	F	2,10	630	504	420	360	315	280	252	210	180	158	140	126	101
		6,9	100	MF	2,55	765	612	510	437	383	340	306	255	219	191	170	153	122
		10,4	150	MF	3,10	930	744	620	531	465	413	372	310	266	233	207	186	149
		13,8	200	MF	3,50	1050	840	700	600	525	467	420	350	300	263	233	210	168

OPTIONALS



Pag. 277

Pag. 238-239

8253093	red
8253094	yellow
8253095	green
8253096	violet
8253097	orange
8253098	gray
8253099	black

MGA



CERAMIC



2,7÷20,7 bar

SERIE MGA - Ugelli per uso a pieno campo senza induzione d'aria

Caratteristiche

- Realizzati in ceramica, con un contenuto di Allumina del 99%;
- Pressione consigliata 2,7 a 20,7 bar.
- Angolo di 60°;
- Riduce le gocce rendendole estremamente fini e formando una copertura molto uniforme;
- Consente una migliore copertura della superficie fogliare e una migliore penetrazione;
- Indicato per l'applicazione di fungicidi e insetticidi sistemici;

MGA SERIES - Nozzles for full-field use without air induction

Features

- Made in ceramic with a 99% alumina content;
- Pressure recommended ranges from 2.7 to 20.7 bar;
- 60° angle;
- Reduces the drops so they are extremely fine to give a really uniform coverage;
- It gives a better coverage of leaf surface and better penetration;
- Suitable for spraying systemic fungicides and insecticides;

SÉRIE MGA - Buses pour utilisation en plein champ sans induction d'air

Caractéristiques

- Réalisées en céramique avec teneur en alumine de 99%.
- Pression recommandée de 2,7 à 20,7 bars.
- Angle de 60°.
- Réduit la dimension des gouttes en les rendant extrêmement fines et forme une couverture très homogène.
- Permet une meilleure couverture de la surface foliaire et une meilleure pénétration.
- Indiquées pour l'application de fongicides et d'insecticides systémiques.



60°

OPTIONALS



Pag. 277



Pag. 238-239

8253093	red
8253094	yellow
8253095	green
8253096	violet
8253097	orange
8253098	gray
8253099	black



NOZZLE SPACING 0,50 m - SPRAYING VOLUME (l/ha)

Part No.	Type	Pressure		VMD	l/min	Nozzle Spacing												
		bar	psi			4 Km/h	5 Km/h	6 Km/h	7 Km/h	8 Km/h	9 Km/h	10 Km/h	12 Km/h	14 Km/h	16 Km/h	18 Km/h	20 Km/h	25 Km/h
8259579	MGA 60-01	2.7	40	MF	0.39	117	94	78	67	59	52	47	39	33	29	26	23	19
		3.8	55	MF	0.45	135	108	90	77	68	60	54	45	39	34	30	27	22
		4.8	70	MF	0.50	150	120	100	86	75	67	60	50	43	38	33	30	24
		6.9	100	MF	0.59	177	142	118	101	89	79	71	59	51	44	39	35	28
		10.4	150	MF	0.68	204	163	136	117	102	91	82	68	58	51	45	41	33
		13.8	200	MF	0.82	246	197	164	141	123	109	98	82	70	62	55	49	39
8259582	MGA 60-015	2.7	40	MF	0.57	171	137	114	98	86	76	68	57	49	43	38	34	27
		3.8	55	MF	0.67	201	161	134	115	101	89	80	67	57	50	45	40	32
		4.8	70	MF	0.75	225	180	150	129	113	100	90	75	64	56	50	45	36
		6.9	100	MF	0.90	270	216	180	154	135	120	108	90	77	68	60	54	43
		10.4	150	MF	1.05	315	252	210	180	158	140	126	105	90	79	70	63	50
		13.8	200	MF	1.25	375	300	250	214	188	167	150	125	107	94	83	75	60
8259583	MGA 60-02	2.7	40	F	0.75	225	180	150	129	113	100	90	75	64	56	50	45	36
		3.8	55	MF	0.87	261	209	174	149	131	116	104	87	75	65	58	52	42
		4.8	70	MF	1.00	300	240	200	171	150	133	120	100	86	75	67	60	48
		6.9	100	MF	1.20	360	288	240	206	180	160	144	120	103	90	80	72	58
		10.4	150	MF	1.42	426	341	284	243	213	189	170	142	122	107	95	85	68
		13.8	200	MF	1.65	495	396	330	283	248	220	198	165	141	124	110	99	79
8259584	MGA 60-025	2.7	40	F	0.95	285	228	190	163	143	127	114	95	81	71	63	57	46
		3.8	55	MF	1.10	330	264	220	189	165	147	132	110	94	83	73	66	53
		4.8	70	MF	1.25	375	300	250	214	188	167	150	125	107	94	83	75	60
		6.9	100	MF	1.50	450	360	300	257	225	200	180	150	129	113	100	90	72
		10.4	150	MF	1.81	543	434	360	302	272	241	217	181	155	136	121	109	87
		13.8	200	MF	2.07	621	497	414	355	311	276	248	207	177	155	138	124	99
8259585	MGA 60-03	2.7	40	F	1.15	345	276	230	197	173	153	138	115	99	86	77	69	55
		3.8	55	F	1.33	399	319	266	228	200	177	160	133	114	100	89	80	64
		4.8	70	MF	1.50	450	360	300	257	225	200	180	150	129	113	100	90	72
		6.9	100	MF	1.80	540	432	360	309	270	240	216	180	154	135	120	108	86
		10.4	150	MF	2.20	660	528	440	377	330	293	264	220	189	165	147	132	106
		13.8	200	MF	2.50	750	600	500	429	375	333	300	250	214	188	167	150	120
8259586	MGA 60-035	2.7	40	F	0.95	285	228	190	163	143	127	114	95	81	71	63	57	46
		3.8	55	F	1.10	330	264	220	189	165	147	132	110	94	83	73	66	53
		4.8	70	MF	1.25	375	300	250	214	188	167	150	125	107	94	83	75	60
		6.9	100	MF	1.50	450	360	300	257	225	200	180	150	129	113	100	90	72
		10.4	150	MF	1.81	543	434	360	310	272	241	217	181	155	136	121	109	87
		13.8	200	MF	2.07	621	497	414	355	311	276	248	207	177	155	138	124	99
8259587	MGA 60-04	2.7	40	F	1.61	483	386	322	276	242	215	193	161	138	121	107	97	77
		3.8	55	F	1.88	564	451	376	322	282	251	226	188	161	141	125	113	90
		4.8	70	F	2.10	630	504	420	360	315	280	252	210	180	158	140	126	101
		6.9	100	MF	2.55	765	612	510	437	383	340	306	255	219	191	170	153	122
		10.4	150	MF	3.10	930	744	620	531	465	413	372	310	266	233	207	186	149
		13.8	200	MF	3.50	1050	840	700	600	525	467	420	350	300	263	233	210	168
8259588	MGA 60-05	2.7	40	F	1.96	588	470	392	336	294	261	235	196	168	147	131	118	94
		3.8	55	F	2.38	714	571	476	408	357	317	286	238	204	179	159	143	114
		4.8	70	F	2.55	765	612	510	437	383	340	306	255	219	191	170	153	122
		6.9	100	F	3.00	900	720	600	514	450	400	360	300	257	225	200	180	144
		10.4	150	MF	3.70	1110	888	740	634	555	493	444	370	317	278	247	222	178
		13.8	200	MF	4.28	1284	1027	856	734	642	571	514	428	367	321	285	257	205
8259589	MGA 60-06	2.7	40	F	2.34	702	562	468	401	351	312	281	234	201	176	156	140	112
		3.8	55	F	2.75	825	660	550	471	413	367	330	275	236	206	183	165	132
		4.8	70	F	2.95	885	708	590	506	443	393	354	295	253	221	197	177	142
		6.9	100	F	3.65	1095	876	730	626	548	487	438	365	313	274	243	219	175
		10.4	150	MF	4.42	1326	1061	884	758	663	589	530	442	379	332	295	265	212
		13.8	200	MF	5.15	1545	1236	1030	883	773	687	618	515	441	386	343	309	247
20.7	300	MF	6.25	1875	1500	1250	1071	938	833	750	625	536	469	417	375	300		

MGA



CERAMIC



SERIE MGA - Ugelli per uso a pieno campo senza induzione d'aria

MGA SERIES - Nozzles for full-field use without air induction

SÉRIE MGA - Buses pour utilisation en plein champ sans induction d'air

Caratteristiche

- Realizzati in ceramica, con un contenuto di Allumina del 99%;
- Pressione consigliata 2,7 a 20,7 bar.
- Angolo di 40°;
- Riduce le gocce rendendole estremamente fini e formando una copertura molto uniforme;
- Consente una migliore copertura della superficie fogliare e una migliore penetrazione;
- Indicato per l'applicazione di fungicidi e insetticidi sistemici;

Features

- Made in ceramic with a 99% alumina content;
- Pressure recommended ranges from 2.7 to 20.7 bar;
- 40° angle;
- Reduces the drops so they are extremely fine to give a really uniform coverage;
- It gives a better coverage of leaf surface and better penetration;
- Suitable for spraying systemic fungicides and insecticides;

Caractéristiques

- Réalisées en céramique avec teneur en alumine de 99%.
- Pression recommandée de 2,7 à 20,7 bars.
- Angle de 40°;
- Réduit la dimension des gouttes en les rendant extrêmement fines et forme une couverture très homogène;
- Permet une meilleure couverture de la surface foliaire et une meilleure pénétration.
- Indiquées pour l'application de fongicides et d'insecticides systémiques.



← 0,50 m →
NOZZLE SPACING 0,50 m - SPRAYING VOLUME (l/ha)

Part No.	Type	bar	psi	VMD l/min	4	5	6	7	8	9	10	12	14	16	18	20	25		
					Km/h	Km/h	Km/h	Km/h	Km/h	Km/h	Km/h	Km/h	Km/h	Km/h	Km/h	Km/h	Km/h	Km/h	Km/h
8259590	MGA 40-01	2.7	40	MF	0.39	117	94	78	67	59	52	47	39	33	29	26	23	19	
		3.8	55	MF	0.45	135	108	90	77	68	60	54	45	39	34	30	27	22	
		4.8	70	MF	0.50	150	120	100	86	75	67	60	50	43	38	33	30	24	
		6.9	100	MF	0.59	177	142	118	101	89	79	71	59	51	44	39	35	28	
		10.4	150	MF	0.68	204	163	136	117	102	91	82	68	58	51	45	41	33	
		13.8	200	MF	0.82	246	197	164	141	123	109	98	82	70	62	55	49	39	
8259591	MGA 40-015	2.7	40	MF	0.57	171	137	114	98	86	76	68	57	49	43	38	34	27	
		3.8	55	MF	0.67	201	161	134	115	101	89	80	67	57	50	45	40	32	
		4.8	70	MF	0.75	225	180	150	129	113	100	90	75	64	56	50	45	36	
		6.9	100	MF	0.90	270	216	180	154	135	120	108	90	77	68	60	54	43	
		10.4	150	MF	1.05	315	252	210	180	158	140	126	105	90	79	70	63	50	
		13.8	200	MF	1.25	375	300	250	214	188	167	150	125	107	94	83	75	60	
8259592	MGA 40-02	2.7	40	F	0.75	225	180	150	129	113	100	90	75	64	56	50	45	36	
		3.8	55	MF	0.87	261	209	174	149	131	116	104	87	75	65	58	52	42	
		4.8	70	MF	1.00	300	240	200	171	150	133	120	100	86	75	67	60	48	
		6.9	100	MF	1.20	360	288	240	206	180	160	144	120	103	90	80	72	58	
		10.4	150	MF	1.42	426	341	284	243	213	189	170	142	122	107	95	85	68	
		13.8	200	MF	1.65	495	396	330	283	248	220	198	165	141	124	110	99	79	
8259593	MGA 40-025	2.7	40	F	0.95	285	228	190	163	143	127	114	95	81	71	63	57	46	
		3.8	55	MF	1.10	330	264	220	189	165	147	132	110	94	83	73	66	53	
		4.8	70	MF	1.25	375	300	250	214	188	167	150	125	107	94	83	75	60	
		6.9	100	MF	1.50	450	360	300	257	225	200	180	150	129	113	100	90	72	
		10.4	150	MF	1.81	543	434	362	310	272	241	217	181	155	136	121	109	87	
		13.8	200	MF	2.07	621	497	414	355	311	276	248	207	177	155	138	124	99	
8259594	MGA 40-03	2.7	40	F	1.15	345	276	230	197	173	153	138	115	99	86	77	69	55	
		3.8	55	F	1.33	399	319	266	228	200	177	160	133	114	100	89	80	64	
		4.8	70	MF	1.50	450	360	300	257	225	200	180	150	129	113	100	90	72	
		6.9	100	MF	1.80	540	432	360	309	270	240	216	180	154	135	120	108	86	
		10.4	150	MF	2.20	660	528	440	377	330	293	264	220	189	165	147	132	106	
		13.8	200	MF	2.50	750	600	500	429	375	333	300	250	214	188	167	150	120	
8259595	MGA 40-035	2.7	40	F	0.95	285	228	190	163	143	127	114	95	81	71	63	57	46	
		3.8	55	F	1.10	330	264	220	189	165	147	132	110	94	83	73	66	53	
		4.8	70	MF	1.25	375	300	250	214	188	167	150	125	107	94	83	75	60	
		6.9	100	MF	1.50	450	360	300	257	225	200	180	150	129	113	100	90	72	
		10.4	150	MF	1.81	543	434	362	310	272	241	217	181	155	136	121	109	87	
		13.8	200	MF	2.07	621	497	414	355	311	276	248	207	177	155	138	124	99	
8259596	MGA 40-04	2.7	40	F	1.61	483	386	322	276	242	215	193	161	138	121	107	97	77	
		3.8	55	F	1.88	564	451	376	322	282	251	226	188	161	141	125	113	90	
		4.8	70	F	2.10	630	504	420	360	315	280	252	210	180	158	140	126	101	
		6.9	100	MF	2.55	765	612	510	437	383	340	306	255	219	191	170	153	122	
		10.4	150	MF	3.10	930	744	620	531	465	413	372	310	266	233	207	186	149	
		13.8	200	MF	3.50	1050	840	700	600	525	467	420	350	300	263	233	210	168	
8259597	MGA 40-05	2.7	40	F	1.96	588	470	392	336	294	261	235	196	168	147	131	118	94	
		3.8	55	F	2.38	714	571	476	408	357	317	286	238	204	179	159	143	114	
		4.8	70	F	2.55	765	612	510	437	383	340	306	255	219	191	170	153	122	
		6.9	100	F	3.00	900	720	600	514	450	400	360	300	257	225	200	180	144	
		10.4	150	MF	3.70	1110	888	740	634	555	493	444	370	317	278	247	222	178	
		13.8	200	MF	4.28	1284	1027	856	734	642	571	514	428	367	321	285	257	205	
20.7	300	MF	5.20	1560	1248	1040	891	780	693	624	520	446	390	347	312	250			

OPTIONALS



Pag. 277

Pag. 238-239

8253093	red
8253094	yellow
8253095	green
8253096	violet
8253097	orange
8253098	gray
8253099	black

MAG



CERAMIC



SERIE MAG CONO VUOTO - Ugelli per uso a pieno campo senza induzione d'aria

Caratteristiche

- Realizzati in ceramica, con un contenuto di Allumina del 99%;
- Pressione consigliata da 4 a 20 bar;
- Angolo di 80°;
- Consente una copertura e una penetrazione eccellenti nel punto da irrorare;
- La serie Mag a cono vuoto può essere usata nei nebulizzatori a barre o in turbo nebulizzatori;
- È necessario prestare molta attenzione nel caso si utilizzi questa serie di ugelli in aree ventose, dal momento che la grandezza delle gocce favorisce la deriva.

MAG SERIES EMPTY CONE - Nozzles for full-field use without air induction

Features

- Made in ceramic with a 99% alumina content;
- Pressure recommended ranges from 4 to 20 bar;
- 80° angle;
- Provides excellent coverage and penetration of the point sprayed;
- The empty cone Mag series can be used on mist blower booms or turbo mist blower;
- Maximum attention must be given when using this series of nozzles in windy areas since the size of the drops does favour drift.

SÉRIE MAG CÔNE VIDE - Buses pour utilisation en plein champ sans induction d'air

Caractéristiques

- Réalisées en céramique avec teneur en alumine de 99%.
- Pression recommandée de 4 à 20 bars.
- Angle de 80°.
- Permet une excellente couverture et une excellente pénétration sur le point à traiter.
- La série Mag à cône vide peut être utilisée sur les pulvérisateurs à barres ou sur les pulvérisateurs turbo.
- Il est important de faire très attention en cas d'utilisation de cette série de buses au sein de zones ventées dans la mesure où la grandeur des gouttes favorise la dérive.



← 0,50 m →
NOZZLE SPACING 0,50 m - SPRAYING VOLUME (l/ha)

Part No.	Type	bar		psi		VMD		Nozzle Spacing (m)																
		4	5	6	7	8	9	10	12	14	16	18	20	25										
8259369	MAG 1 HOLLOW CONE	4,1	60	F	0,32	96	77	64	55	48	43	38	32	27	24	21	19	15						
		6,2	90	F	0,38	114	91	76	65	57	51	46	38	33	29	25	23	18						
		10,4	150	F	0,50	150	120	100	86	75	67	60	50	43	38	33	30	24						
		14,5	210	F	0,55	165	132	110	94	83	73	66	55	47	41	37	33	26						
8259370	MAG 1,5 HOLLOW CONE	4,1	60	F	0,43	129	103	86	74	65	57	52	43	37	32	29	26	21						
		6,2	90	F	0,52	156	125	104	89	78	69	62	52	45	39	35	31	25						
		10,4	150	F	0,66	198	158	132	113	99	88	79	66	57	50	44	40	32						
		14,5	210	F	0,77	231	185	154	132	116	103	92	77	66	58	51	46	37						
8259371	MAG 2 HOLLOW CONE	4,1	60	F	0,64	192	154	128	110	96	85	77	64	55	48	43	38	31						
		6,2	90	F	0,76	228	182	152	130	114	101	91	76	65	57	51	46	36						
		10,4	150	F	1,00	300	240	200	171	150	133	120	100	86	75	67	60	48						
		14,5	210	F	1,13	339	271	226	194	170	151	136	113	97	85	75	68	54						
8259372	MAG 3 HOLLOW CONE	4,1	60	F	0,88	264	211	176	151	132	117	106	88	75	66	59	53	42						
		6,2	90	F	1,06	318	254	212	182	159	141	127	106	91	80	71	64	51						
		10,4	150	F	1,34	402	322	268	230	201	179	161	134	115	101	89	80	64						
		14,5	210	F	1,57	471	377	314	269	236	209	188	157	135	118	105	94	75						
8259373	MAG 4 HOLLOW CONE	4,1	60	F	1,25	375	300	250	214	188	167	150	125	107	94	83	75	60						
		6,2	90	F	1,51	453	362	302	259	227	201	181	151	129	113	101	91	72						
		10,4	150	F	1,91	573	458	382	327	287	255	229	191	164	143	127	115	92						
		14,5	210	F	2,22	666	533	444	381	333	296	266	222	190	167	148	133	107						
8259374	MAG 5 HOLLOW CONE	4,1	60	F	1,60	480	384	320	274	240	213	192	160	137	120	107	96	77						
		6,2	90	F	1,93	579	463	386	331	290	257	232	193	165	145	129	116	93						
		10,4	150	F	2,44	732	586	488	418	366	325	293	244	209	183	163	146	117						
		14,5	210	F	2,85	855	684	570	489	428	380	342	285	244	214	190	171	137						
8259375	MAG 6 HOLLOW CONE	4,1	60	F	2,10	630	504	420	360	315	280	252	210	180	158	140	126	101						
		6,2	90	F	2,40	720	576	480	411	360	320	288	240	206	180	160	144	115						
		10,4	150	F	3,00	900	720	600	514	450	400	360	300	257	225	200	180	144						
		14,5	210	F	3,50	1050	840	700	600	525	467	420	350	300	263	233	210	168						

OPTIONALS



Pag. 277

Pag. 238-239

8253086	red
8253087	yellow
8253088	green
8253089	blue
8253090	orange
8253091	brown
8253092	black

MAG-CH



CERAMIC



3,5÷10 bar

SERIE MAG-CH CONO PIENO - Ugelli per uso a pieno campo senza induzione d'aria

Caratteristiche

- Realizzati in ceramica, con un contenuto di Allumina del 99%;
- Cono pieno con angolo di 80°;
- Pressione consigliata da 3,5 a 10 bar;
- Produce gocce da fini a molto fini, in base alla pressione di lavoro;
- Consente una copertura e una penetrazione eccellenti nel punto da irrorare;
- È necessario prestare molta attenzione nel caso si utilizzi questa serie di ugelli in aree ventose, dal momento che la grandezza delle gocce favorisce la deriva.

MAG-CH SERIES SOLID CONE - Nozzles for full-field use without air induction

Features

- Made in ceramic with a 99% alumina content;
- Solid cone with an 80° angle;
- Pressure recommended ranges from 3,5 to 10 bar;
- Produces fine to very fine drops depending on the working pressure;
- Provides excellent coverage and penetration of the point sprayed;
- Maximum attention must be given when using this series of nozzles in windy areas since the size of the drops does favour drift.

SÉRIE MAG-CH CÔNE PLEIN - Buses pour utilisation en plein champ sans induction d'air

Caractéristiques

- Réalisées en céramique avec teneur en alumine de 99%.
- Cône plein à angle de 80°.
- Pression recommandée de 3,5 à 10 bars.
- Produit des gouttes de fines à très fines, en fonction de la pression de service.
- Permet une excellente couverture et une excellente pénétration sur le point à traiter.
- Il est important de faire très attention en cas d'utilisation de cette série de buses au sein de zones ventées dans la mesure où la grandeur des gouttes favorise la dérive.



← 0,50 m →
NOZZLE SPACING 0,50 m - SPRAYING VOLUME (l/h)

Part No.	Type	bar	psi	VMD	NOZZLE SPACING 0,50 m - SPRAYING VOLUME (l/h)															
					l/min	4 Km/h	5 Km/h	6 Km/h	7 Km/h	8 Km/h	9 Km/h	10 Km/h	12 Km/h	14 Km/h	16 Km/h	18 Km/h	20 Km/h	25 Km/h		
8259376	MAG-CH 0,5	3,4	50	F	0,56	168	134	112	96	84	75	67	56	48	42	37	34	27		
		4,8	70	F	0,66	198	158	132	113	99	88	79	66	57	50	44	40	32		
		6,2	90	F	0,74	222	178	148	127	111	99	89	74	63	56	49	44	36		
		7,6	110	MF	0,82	246	197	164	141	123	109	98	82	70	62	55	49	39		
		9	130	MF	0,84	252	202	168	144	126	112	101	84	72	63	56	50	40		
8259377	MAG-CH 0,75	3,4	50	F	0,75	225	180	150	129	113	100	90	75	64	56	50	45	36		
		4,8	70	F	0,90	270	216	180	154	135	120	108	90	77	68	60	54	43		
		6,2	90	F	1,00	300	240	200	171	150	133	120	100	86	75	67	60	48		
		7,6	110	F	1,10	330	264	220	189	165	147	132	110	94	83	73	66	53		
		9	130	MF	1,20	360	288	240	206	180	160	144	120	103	90	80	72	58		
8259378	MAG-CH 1	3,4	50	F	1,00	300	240	200	171	150	133	120	100	86	75	67	60	48		
		4,8	70	F	1,20	360	288	240	206	180	160	144	120	103	90	80	72	58		
		6,2	90	F	1,33	399	319	266	228	200	177	160	133	114	100	89	80	64		
		7,6	110	F	1,47	441	353	294	252	221	196	176	147	126	110	98	88	71		
		9	130	MF	1,63	489	391	326	279	245	217	196	163	140	122	109	98	78		
8259379	MAG-CH 2	3,4	50	F	1,28	384	307	256	219	192	171	154	128	110	96	85	77	61		
		4,8	70	F	1,52	456	365	304	261	228	203	182	152	130	114	101	91	73		
		6,2	90	F	1,72	516	413	344	295	258	229	206	172	147	129	115	103	83		
		7,6	110	F	1,90	570	456	380	326	285	253	228	190	163	143	127	114	91		
		9	130	F	2,05	615	492	410	351	308	273	246	205	176	154	137	123	98		
8259380	MAG-CH 3	3,4	50	F	2,17	651	521	434	372	326	289	260	217	186	163	145	130	104		
		4,8	70	F	1,50	450	360	300	257	225	200	180	150	129	113	100	90	72		
		6,2	90	F	1,75	525	420	350	300	263	233	210	175	150	131	117	105	84		
		7,6	110	F	2,00	600	480	400	343	300	267	240	200	171	150	133	120	96		
		9	130	F	2,20	660	528	440	377	330	293	264	220	189	165	147	132	106		
8259381	MAG-CH 4	3,4	50	F	2,40	720	576	480	411	360	320	288	240	206	180	160	144	115		
		4,8	70	F	2,55	765	612	510	437	383	340	306	255	219	191	170	153	122		
		6,2	90	M	1,94	582	466	388	333	291	259	233	194	166	146	129	116	93		
		7,6	110	F	2,25	675	540	450	386	338	300	270	225	193	169	150	135	108		
		9	130	F	2,53	759	607	506	434	380	337	304	253	217	190	169	152	121		
8259382	MAG-CH 5	3,4	50	F	2,82	846	677	564	483	423	376	338	282	242	212	188	169	135		
		4,8	70	F	3,00	900	720	600	514	450	400	360	300	257	225	200	180	144		
		6,2	90	F	3,25	975	780	650	557	488	433	390	325	279	244	217	195	156		
		7,6	110	M	2,13	639	511	426	365	320	284	256	213	183	160	142	128	102		
		9	130	F	2,55	765	612	510	437	383	340	306	255	219	191	170	153	122		
8259383	MAG-CH 6	3,4	50	F	2,96	888	710	592	507	444	395	355	296	254	222	197	178	142		
		4,8	70	F	3,28	984	787	656	562	492	437	394	328	281	246	219	197	157		
		6,2	90	F	3,50	1050	840	700	600	525	467	420	350	300	263	233	210	168		
		7,6	110	F	3,75	1125	900	750	643	563	500	450	375	321	281	250	225	180		
		9	130	F	4,08	1224	979	816	699	612	544	490	408	350	306	272	245	196		

OPTIONALS



Pag. 277

Pag. 238-239

8253100	red
8253101	yellow
8253102	green
8253103	blue
8253104	orange
8253105	violet
8253106	black

CV-IA



CERAMIC



3÷10 bar

SERIE CV-IA CONO VUOTO A INDUZIONE D'ARIA

Ugelli per uso a pieno campo a induzione d'aria

Caratteristiche

- Realizzati in ceramica, con un contenuto di Allumina del 99%;
- Pressione di lavoro da 3 a 10 bar;
- Indicato per l'applicazione di fungicidi e insetticidi sistemici;
- Angolo di apertura di 100°;
- Permette di lavorare con venti fino a 15 km/h.

CV-IA SERIES AIR INDUCTION EMPTY CONE

Air induction nozzles for full-field use

Features

- Made in ceramic with a 99% alumina content;
- Working pressure ranges from 3 to 10 bar;
- Suitable for spraying systemic fungicides and insecticides;
- 100° opening angle;
- It can be used with winds up to 15 km/h.

SÉRIE CV-IA CÔNE VIDE À INDUCTION D'AIR

Buses pour utilisation en plein champ à induction d'air

Caractéristiques

- Réalisées en céramique avec teneur en alumine de 99%.
- Pression de service de 3 à 10 bars.
- Indiquées pour l'application de fongicides et d'insecticides systémiques.
- Angle d'ouverture de 100°.
- Permet d'opérer en présence de vents de 15 km/h max.



← 0,50 m →
NOZZLE SPACING 0,50 m - SPRAYING VOLUME (l/ha)

Part No.	Type	bar	psi	VMD	SPRAYING VOLUME (l/ha)															
					l/min	4 Km/h	5 Km/h	6 Km/h	7 Km/h	8 Km/h	9 Km/h	10 Km/h	12 Km/h	14 Km/h	16 Km/h	18 Km/h	20 Km/h	25 Km/h		
8259418	CV-IA 01	3,1	45	EG	0,43	129	103	86	74	65	57	52	43	37	32	29	26	21		
		4,1	60	EG	0,50	150	120	100	86	75	67	60	50	43	38	33	30	24		
		5,5	80	EG	0,57	171	137	114	98	86	76	68	57	49	43	38	34	27		
		6,9	100	MG	0,63	189	151	126	108	95	84	76	63	54	47	42	38	30		
		8,3	120	MG	0,68	204	163	136	117	102	91	82	68	58	51	45	41	33		
8259419	CV-IA 015	3,1	45	EG	0,62	186	149	124	106	93	83	74	62	53	47	41	37	30		
		4,1	60	EG	0,70	210	168	140	120	105	93	84	70	60	53	47	42	34		
		5,5	80	EG	0,82	246	197	164	141	123	109	98	82	70	62	55	49	39		
		6,9	100	MG	0,90	270	216	180	154	135	120	108	90	77	68	60	54	43		
		8,3	120	MG	0,99	297	238	198	170	149	132	119	99	85	74	66	59	48		
8259420	CV-IA 02	3,1	45	EG	0,78	234	187	156	134	117	104	94	78	67	59	52	47	37		
		4,1	60	EG	0,90	270	216	180	154	135	120	108	90	77	68	60	54	43		
		5,5	80	EG	1,02	306	245	204	175	153	136	122	102	87	77	68	61	49		
		6,9	100	MG	1,12	336	269	224	192	168	149	134	112	96	84	75	67	54		
		8,3	120	MG	1,22	366	293	244	209	183	163	146	122	105	92	81	73	59		
8259421	CV-IA 025	3,1	45	EG	1,04	312	250	208	178	156	139	125	104	89	78	69	62	50		
		4,1	60	EG	1,20	360	288	240	206	180	160	144	120	103	90	80	72	58		
		5,5	80	EG	1,38	414	331	276	237	207	184	166	138	118	104	92	83	66		
		6,9	100	MG	1,60	480	384	320	274	240	213	192	160	137	120	107	96	77		
		8,3	120	MG	1,75	525	420	350	300	263	233	210	175	150	131	117	105	84		
8259422	CV-IA 03	3,1	45	EG	1,22	366	293	244	209	183	163	146	122	105	92	81	73	59		
		4,1	60	EG	1,40	420	336	280	240	210	187	168	140	120	105	93	84	67		
		5,5	80	EG	1,64	492	394	328	281	246	219	197	164	141	123	109	98	79		
		6,9	100	MG	1,90	570	456	380	326	285	253	228	190	163	143	127	114	91		
		8,3	120	MG	2,03	609	487	406	348	305	271	244	203	174	152	135	122	97		
8259423	CV-IA 04	3,1	45	EG	1,56	468	374	312	267	234	208	187	156	134	117	104	94	75		
		4,1	60	EG	1,80	540	432	360	309	270	240	216	180	154	135	120	108	86		
		5,5	80	EG	2,07	621	497	414	355	311	276	248	207	177	155	138	124	99		
		6,9	100	MG	2,35	705	564	470	403	353	313	282	235	201	176	157	141	113		
		8,3	120	MG	2,58	774	619	516	442	387	344	310	258	221	194	172	155	124		
8259424	CV-IA 05	3,1	45	EG	2,00	600	480	400	343	300	267	240	200	171	150	133	120	96		
		4,1	60	EG	2,30	690	552	460	394	345	307	276	230	197	173	153	138	110		
		5,5	80	EG	2,65	795	636	530	454	398	353	318	265	227	199	177	159	127		
		6,9	100	EG	3,03	909	727	606	519	455	404	364	303	260	227	202	182	145		
		8,3	120	MG	3,30	990	792	660	566	495	440	396	330	283	248	220	198	158		
		10,4	150	MG	3,66	1098	878	732	627	549	488	439	366	314	275	244	220	176		

OPTIONALS



Pag. 277

Pag. 238-239

8253100	red
8253101	yellow
8253102	green
8253103	blue
8253104	orange
8253105	violet
8253106	black

X



CERAMIC



5,5÷13,8 bar

SERIE X CONO VUOTO

Ugelli per uso a pieno campo senza induzione d'aria

Caratteristiche

- Realizzati in ceramica, con un contenuto di Allumina del 99%;
- Pressione consigliata da 5,5 a 13,8 bar;
- Angolo di 85°;
- Riduce le gocce rendendole estremamente fini formando una copertura molto uniforme;
- Si sconsiglia l'utilizzo di questa serie in luoghi ventosi, poiché a causa della grandezza delle sue gocce si corre il rischio di un forte effetto deriva.

X SERIES EMPTY CONE

Nozzles for full-field use without air induction

Features

- Made in ceramic with a 99% alumina content;
- Pressure recommended ranges from 5,5 to 13,8 bar;
- 85° angle;
- Reduces the drops so they are extremely fine to give a really uniform coverage;
- This series of nozzles should not be used where it is windy because given the size of the drops there is the danger of a strong drift effect.

SÉRIE X CÔNE VIDE

Buses pour utilisation en plein champ sans induction d'air

Caractéristiques

- Réalisées en céramique avec teneur en alumine de 99%.
- Pression recommandée de 5,5 à 13,8 bars.
- Angle de 85°.
- Réduit la dimension des gouttes en les rendant extrêmement fines et forme une couverture très homogène.
- Il est déconseillé d'utiliser cette série au sein de zones ventées dans la mesure où la grandeur des gouttes expose à un risque de forte dérive.



← 0,50 m →
NOZZLE SPACING 0,50 m - SPRAYING VOLUME (l/ha)

Part No.	Type	bar	psi	VMD	l/min	3	4	5	6	7	8
						Km/h	Km/h	Km/h	Km/h	Km/h	Km/h
8259384	X 0.50	5,5	80	MF	0,05	33	25	20	17	14	13
		6,9	100	MF	0,065	43	33	26	22	19	16
		10,4	150	MF	0,08	53	40	32	27	23	20
		13,8	200	MF	0,90	60	45	36	30	26	23
8259385	X 1	5,5	80	MF	0,13	87	65	52	43	37	33
		6,9	100	MF	0,14	93	70	56	47	40	35
		10,4	150	MF	0,16	107	80	64	53	46	40
		13,8	200	MF	0,19	127	95	76	63	54	48
8259386	X 2	5,5	80	MF	0,17	113	85	68	57	49	43
		6,9	100	MF	0,19	127	95	76	63	54	48
		10,4	150	MF	0,23	153	115	92	77	66	58
		13,8	200	MF	0,27	180	135	108	90	77	68
8259387	X 3	5,5	80	F	0,26	173	130	104	87	74	65
		6,9	100	MF	0,29	193	145	116	97	83	73
		10,4	150	MF	0,35	233	175	140	117	100	88
		13,8	200	MF	0,42	280	210	168	140	120	105

OPTIONALS



Pag. 277



Pag. 238-239

8253107	red
8253108	blue
8253109	white
8253110	orange
8253111	red
8253112	yellow

TM-IA



150°



CERAMIC



2÷6 bar

SERIE TM-IA TURBO A INDUZIONE D'ARIA
Ugelli per uso a pieno campo a induzione d'aria

Caratteristiche

- Realizzati in ceramica, con un contenuto di Allumina del 99%;
- Pressione consigliata da 2 a 6 bar;
- Angolo di 150°;
- Dispone di un sistema Venturi a induzione d'aria nelle gocce, che consente a queste ultime di raggiungere grandi dimensioni, anche alle pressioni più elevate;
- Permette di lavorare con venti che raggiungono i 20 km/h.

TM-IA SERIES AIR INDUCTION TURBO
Air induction nozzles for full-field use

Features

- Made in ceramic with a 99% alumina content;
- Pressure recommended ranges from 2 to 6 bar;
- 150° angle
- It has a Venturi air induction system for the drops so they can become very big even at high pressures.
- It can be used even with 20 km/h winds.

SÉRIE TM-IA TURBO À INDUCTION D'AIR
Buses pour utilisation en plein champ à induction d'air

Caractéristiques

- Réalisées en céramique avec teneur en alumine de 99%.
- Pression recommandée de 2 à 6 bars.
- Angle de 150°.
- Dispose d'un système Venturi à induction d'air dans les gouttes qui permet à celles-ci d'atteindre une grande taille y compris aux pressions les plus élevées.
- Permet d'opérer en présence de vents de 20 km/h.



NOZZLE SPACING 1,00 m - SPRAYING VOLUME (l/ha)

Part No.	Type	bar	psi	VMD	l/min	NOZZLE SPACING 1,00 m - SPRAYING VOLUME (l/ha)															
						4 Km/h	5 Km/h	6 Km/h	7 Km/h	8 Km/h	9 Km/h	10 Km/h	12 Km/h	14 Km/h	16 Km/h	18 Km/h	20 Km/h	25 Km/h			
8259425	TM-IA 0,50	2	30	EG	0,50	75	60	50	43	38	33	30	25	21	19	17	15	12			
		3,1	45	EG	0,62	93	74	62	53	47	41	37	31	27	23	21	19	15			
		4,1	60	EG	0,72	108	86	72	62	54	48	43	36	31	27	24	22	17			
		5,2	75	EG	0,80	120	96	80	69	60	53	48	40	34	30	27	24	19			
8259426	TM-IA 0,75	2	30	EG	0,54	81	65	54	46	41	36	32	27	23	20	18	16	13			
		3,1	45	EG	0,66	99	79	66	57	50	44	40	33	28	25	22	20	16			
		4,1	60	EG	0,76	114	91	76	65	57	51	46	38	33	29	25	23	18			
		5,2	75	EG	0,86	129	103	86	74	65	57	52	43	37	32	29	26	21			
8259427	TM-IA 1	2	30	EG	0,67	101	80	67	57	50	45	40	34	29	25	22	20	16			
		3,1	45	EG	0,82	123	98	82	70	62	55	49	41	35	31	27	25	20			
		4,1	60	EG	0,95	143	114	95	81	71	63	57	48	41	36	32	29	23			
		5,2	75	EG	1,06	159	127	106	91	80	71	64	53	45	40	35	32	25			
8259428	TM-IA 1,5	2	30	EG	0,91	137	109	91	78	68	61	55	46	39	34	30	27	22			
		3,1	45	EG	1,12	168	134	112	96	84	75	67	56	48	42	37	34	27			
		4,1	60	EG	1,32	198	158	132	113	99	88	79	66	57	50	44	40	32			
		5,2	75	EG	1,46	219	175	146	125	110	97	88	73	63	55	49	44	35			
8259429	TM-IA 2	2	30	EG	1,32	198	158	132	113	99	88	79	66	57	50	44	40	32			
		3,1	45	EG	1,60	240	192	160	137	120	107	96	80	69	60	53	48	38			
		4,1	60	EG	1,85	278	222	185	159	139	123	111	93	79	69	62	56	44			
		5,2	75	EG	2,07	311	248	207	177	155	138	124	104	89	78	69	62	50			
8259430	TM-IA 2,5	2	30	EG	1,65	248	198	165	141	124	110	99	83	71	62	55	50	40			
		3,1	45	EG	1,98	297	238	198	170	149	132	119	99	85	74	66	59	48			
		4,1	60	EG	2,28	342	274	228	195	171	152	137	114	98	86	76	68	55			
		5,2	75	EG	2,54	381	305	254	218	191	169	152	127	109	95	85	76	61			
8259431	TM-IA 3	2	30	EG	2,00	300	240	200	171	150	133	120	100	86	75	67	60	48			
		3,1	45	EG	2,45	368	294	245	210	184	163	147	123	105	92	82	74	59			
		4,1	60	EG	2,81	422	337	281	241	211	187	169	141	120	105	94	84	67			
		5,2	75	EG	3,15	473	378	315	270	236	210	189	158	135	118	105	95	76			
8259432	TM-IA 4	2	30	EG	2,67	401	320	267	229	200	178	160	134	114	100	89	80	64			
		3,1	45	EG	3,26	489	391	326	279	245	217	196	163	140	122	109	98	78			
		4,1	60	EG	3,77	566	452	377	323	283	251	226	189	162	141	126	112	101			
		5,2	75	EG	4,22	633	506	422	362	317	281	253	211	181	158	141	127	101			
8259433	TM-IA 5	2	30	EG	4,50	675	540	450	386	338	300	270	225	193	169	150	135	108			
		3,1	45	EG	3,25	488	390	325	279	244	217	195	163	139	122	108	98	78			
		4,1	60	EG	3,97	596	476	397	340	298	265	238	199	170	149	132	119	95			
		5,2	75	EG	4,50	675	540	450	386	338	300	270	225	193	169	150	135	108			
8259434	TM-J 7,5	2	30	EG	5,10	765	612	510	437	383	340	306	255	219	191	170	153	122			
		3,1	45	EG	6,24	936	749	624	535	468	416	374	312	267	234	208	187	150			
		4,1	60	EG	6,85	1028	822	685	587	514	457	411	343	294	257	228	206	164			
		5,2	75	EG	7,45	1118	894	745	639	559	497	447	373	319	279	248	224	179			
		6,2	90	EG	8,00	1200	960	800	686	600	533	480	400	343	300	267	240	192			

OPTIONALS



Pag. 277



Pag. 238-239

8253028	red
8253029	yellow
8253030	green
8253031	blue
8253069	orange
8253070	brown
8253071	black
8253126	white
8253127	light blue
8253128	violet

PB



CERAMIC



2÷4 bar

SERIE PB ECCENTRICO

Ugelli per l'applicazione a banda stretta in punta di barra

Caratteristiche

- Getto piatto, decentrato, usato in punta di barra;
- Angolo di 60°;
- Pressione di lavoro da 2 a 4 bar;
- Usato in applicazioni a banda stretta o altre complementari con barra, quali ad esempio: cordoni, fasce tagliafuoco, pulizia di burroni, bordi di autostrade, fertilizzanti liquidi a banda o orientati.

PB SERIES BOOM TIP

Nozzles for narrow strip application on boom tip

Features

- Flat, offset jet used on the boom tip;
- 60° angle;
- Working pressure ranges from 2 to 4 bar;
- Used for narrow strip applications or other accessories with boom, such as, for example: cordons, firebreak strips, cleaning ravines, motorway edges, liquid fertilisers.

SÉRIE PB EXCENTRIQUE

Buses pour application à bande étroite sur extrémité de barre

Caractéristiques

- Jet plat et décentré, utilisé sur extrémité de barre.
- Angle de 60°.
- Pression de service de 2 à 4 bars.
- Série utilisée pour applications à bande étroite ou autres applications complémentaires avec barre, par exemple : cordons, bandes pare-feu, nettoyage des ravins, bordures d'autoroutes, fertilisants liquides à bande ou orientés.



← 0,50 m →
NOZZLE SPACING 0,50 m - SPRAYING VOLUME (l/ha)

Part No.	Type	bar	psi	VMD	l/min	NOZZLE SPACING 0,50 m - SPRAYING VOLUME (l/ha)															
						4 Km/h	5 Km/h	6 Km/h	7 Km/h	8 Km/h	9 Km/h	10 Km/h	12 Km/h	14 Km/h	16 Km/h	18 Km/h	20 Km/h	25 Km/h			
8259457	PB 01	2	30	M	0,32	96	77	64	55	48	43	38	32	27	24	21	19	15			
		3,1	45	F	0,41	123	98	82	70	62	55	49	41	35	31	27	25	20			
		4,1	60	F	0,46	138	110	92	79	69	61	55	46	39	35	31	28	22			
8259458	PB 015	2	30	M	0,50	150	120	100	86	75	67	60	50	43	38	33	30	24			
		3,1	45	F	0,61	183	146	122	105	92	81	73	61	52	46	41	37	29			
		4,1	60	F	0,70	210	168	140	120	105	93	84	70	60	53	47	42	34			
8259459	PB 02	2	30	M	0,66	198	158	132	113	99	88	79	66	57	50	44	40	32			
		3,1	45	M	0,82	246	197	164	141	123	109	98	82	70	62	55	49	39			
		4,1	60	F	0,95	285	228	190	163	143	127	114	95	81	71	63	57	46			
8259460	PB 03	2	30	M	1,00	300	240	200	171	150	133	120	100	86	75	67	60	48			
		3,1	45	M	1,25	375	300	250	214	188	167	150	125	107	94	83	75	60			
		4,1	60	M	1,43	429	343	286	245	215	191	172	143	123	107	95	86	69			
8259461	PB 04	2	30	M	1,32	396	317	264	226	198	176	158	132	113	99	88	79	63			
		3,1	45	M	1,62	486	389	324	278	243	216	194	162	139	122	108	97	78			
		4,1	60	M	1,89	567	454	378	324	284	252	227	189	162	142	126	113	91			
8259462	PB 05	2	30	M	1,67	501	401	334	286	251	223	200	167	143	125	111	100	80			
		3,1	45	M	2,07	621	497	414	355	311	276	248	207	177	155	138	124	99			
		4,1	60	F	2,39	717	574	478	410	359	319	287	239	205	179	159	143	115			
8259567	PB 06	2	30	M	2,02	606	485	404	346	303	269	242	202	173	152	135	121	97			
		3,1	45	M	2,49	747	598	498	427	374	332	299	249	213	187	166	149	120			
		4,1	60	F	2,86	858	686	572	490	429	381	343	286	245	215	191	172	137			

OPTIONALS



Pag. 277



Pag. 238-239

8253000	red
8253001	yellow
8253002	green
8253003	blue
8253041	white
8253042	orange
8253043	brown
8253048	black
8253118	grey
8253119	violet

PB-IA



60°



CERAMIC



2÷7,5 bar

SERIE PB-IA ECCENTRICO A INDUZIONE D'ARIA - Ugelli per l'applicazione a banda stretta in punta di barra

Caratteristiche

- Getto piatto, decentrato, a induzione d'aria, usato in punta di barra;
- Angolo di 60°;
- Pressione di lavoro da 2 a 7,5 bar;
- Buon controllo di deriva con venti fino a 15 km/h;
- Camera rimovibile per facilitarne la pulizia;
- Usato in applicazioni a banda stretta o altre complementari con barra, quali ad esempio: cordoni, fasce tagliafuoco, pulizia di burroni, bordi di autostrade, fertilizzanti liquidi a banda o orientati.

PB-IA SERIES AIR INDUCTION BOOM TIP
Nozzles for narrow strip application on boom tip

Features

- Flat, offset air induction jet used on the boom tip;
- 60° angle;
- Working pressure ranges from 2 to 7,5 bar;
- Good control of drift with winds up to 15 km/h;
- Removable chamber for easier cleaning;
- Used for narrow strip applications or other accessories with boom, such as, for example: cordons, firebreak strips, cleaning ravines, motorway edges, strip or oriented liquid fertilisers.

SÉRIE PB-IA EXCENTRIQUE À INDUCTION D'AIR - Buses pour application à bande étroite sur extrémité de barre

Caractéristiques

- Jet plat et décentré, à induction d'air, utilisé sur extrémité de barre.
- Angle de 60°.
- Pression de service de 2 à 7,5 bars.
- Bon contrôle de la dérive en présence de vents de 15 km/h max.
- Chambre amovible pour en faciliter le nettoyage.
- Série utilisée pour applications à bande étroite ou autres applications complémentaires avec barre, par exemple : cordons, bandes pare-feu, nettoyage des ravins, bordures d'autoroutes, fertilisants liquides à bande ou orientés.

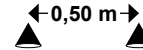

NOZZLE SPACING 0,50 m - SPRAYING VOLUME (l/ha)

Part No.	Type	bar	psi	VMD	l/min	NOZZLE SPACING 0,50 m - SPRAYING VOLUME (l/ha)															
						4 Km/h	5 Km/h	6 Km/h	7 Km/h	8 Km/h	9 Km/h	10 Km/h	12 Km/h	14 Km/h	16 Km/h	18 Km/h	20 Km/h	25 Km/h			
8259463	PB-IA 60-01	2	30	EG	0,38	114	91	76	65	57	51	46	38	33	29	25	23	18			
		3,4	50	MG	0,43	129	103	86	74	65	57	52	43	37	32	29	26	21			
		4,8	70	MG	0,50	150	120	100	86	75	67	60	50	43	38	33	30	24			
		6,2	90	G	0,56	168	134	112	96	84	75	67	56	48	42	37	34	27			
		7,6	110	G	0,62	186	149	124	106	93	83	74	62	53	47	41	37	30			
8259464	PB-IA 60-015	2	30	EG	0,48	144	115	96	82	72	64	58	48	41	36	32	29	23			
		3,4	50	MG	0,65	195	156	130	111	98	87	78	65	56	49	43	39	31			
		4,8	70	MG	0,77	231	185	154	132	116	103	92	77	66	58	51	46	37			
		6,2	90	MG	0,86	258	206	172	147	129	115	103	86	74	65	57	52	41			
		7,6	110	G	0,95	285	228	190	163	143	127	114	95	81	71	63	57	46			
8259465	PB-IA 60-02	2	30	EG	0,67	201	161	134	115	101	89	80	67	57	50	45	40	32			
		3,4	50	EG	0,89	267	214	178	153	134	119	107	89	76	67	59	53	43			
		4,8	70	MG	1,04	312	250	208	178	156	139	125	104	89	78	69	62	50			
		6,2	90	MG	1,18	354	283	236	202	177	157	142	118	101	89	79	71	57			
		7,6	110	G	1,29	387	310	258	221	194	172	155	129	111	97	86	77	62			
8259466	PB-IA 60-025	2	30	EG	0,83	249	199	166	142	125	111	100	83	71	62	55	50	40			
		3,4	50	EG	1,09	327	262	218	187	164	145	131	109	93	82	73	65	52			
		4,8	70	MG	1,29	387	310	258	221	194	172	155	129	111	97	86	77	62			
		6,2	90	MG	1,46	438	350	292	250	219	195	175	146	125	110	97	88	70			
		7,6	110	G	1,61	483	386	322	276	242	215	193	161	138	121	107	97	77			
8259467	PB-IA 60-03	2	30	EG	1,01	303	242	202	173	152	135	121	101	87	76	67	61	48			
		3,4	50	EG	1,33	399	319	266	228	200	177	160	133	114	100	89	80	64			
		4,8	70	MG	1,58	474	379	316	271	237	211	190	158	135	119	105	95	76			
		6,2	90	MG	1,80	540	432	360	309	270	240	216	180	154	135	120	108	86			
		7,6	110	MG	1,97	591	473	394	338	296	263	236	197	169	148	131	118	95			
8259468	PB-IA 60-04	2	30	EG	1,33	399	319	266	228	200	177	160	133	114	100	89	80	64			
		3,4	50	EG	1,73	519	415	346	297	260	231	208	173	148	130	115	104	83			
		4,8	70	MG	2,06	618	494	412	353	309	275	247	206	177	155	137	124	99			
		6,2	90	MG	2,32	696	557	464	398	348	309	278	232	199	174	155	139	111			
		7,6	110	MG	2,57	771	617	514	441	386	343	308	257	220	193	171	154	123			
8259469	PB-IA 60-05	2	30	EG	1,64	492	394	328	281	246	219	197	164	141	123	109	98	79			
		3,4	50	EG	2,14	642	514	428	367	321	285	257	214	183	161	143	128	103			
		4,8	70	EG	2,56	768	614	512	439	384	341	307	256	219	192	171	154	123			
		6,2	90	MG	2,87	861	689	574	492	431	383	344	287	246	215	191	172	138			
		7,6	110	MG	3,17	951	761	634	543	476	423	380	317	272	238	211	190	152			
8259470	PB-IA 60-06	2	30	EG	2,00	600	480	400	343	300	267	240	204	175	153	133	120	98			
		3,4	50	EG	2,57	771	617	514	441	386	343	308	260	223	195	171	154	125			
		4,8	70	EG	3,03	909	727	606	519	455	404	364	308	264	231	202	182	148			
		6,2	90	MG	3,53	1.059	847	706	605	530	471	424	344	295	258	235	212	165			
		7,6	110	MG	3,85	1.155	924	770	660	577	513	462	381	326	285	256	231	183			

OPTIONALS



Pag. 277



Pag. 238-239

8253028	red
8253029	yellow
8253030	green
8253031	blue
8253069	orange
8253070	brown
8253071	black
8253126	white
8253127	light blue
8253128	violet

MX



CERAMIC



2÷5 bar

SERIE MX

Ugelli per uso a pieno campo

Caratteristiche

- Tutti i modelli sono realizzati in ceramica, con un contenuto di allumina del 99%, corpo in Resina acetalica
- Pressione consigliata da 2 a 6 bar
- L'impiego è consigliato in impianti senza barra.
- Utilizzabile come ugello fine barra per estendere la larghezza del trattamento
- Può raggiungere i 6.5 metri di estensione anche a basse pressioni
- L'impiego è particolarmente consigliato per pascoli, foreste, ferrovie, campi da golf, e impianti ATV su moto quad.

MX SERIES

Nozzles for full-field use

Features

- Made in ceramic with a 99% Alumina content, body in Acetal resin;
- Pressure recommended ranges from 2 to 6 bar;
- Recommended use on systems without bars.
- Can be used as a nozzle at the end of the bar to extend its reach.
- Can reach an extension of up to 6.5 m, even at low pressures.
- Particularly indicated for treating grassland, forests, railroads, golf courses and on All-Terrain Vehicles (quad bikes).

SÉRIE MX

Buses pour utilisation en plein champ

Caractéristiques

- Tous les modèles sont réalisés en céramique avec contenu d'alumine de 99%, corps en résine d'acétal.
- Pression recommandée de 2 à 6 bars.
- L'utilisation est conseillée sur les installations sans barre.
- Utilisable comme buse d'extrémité de barre pour étendre la largeur du traitement.
- Peut atteindre 6,5 mètres d'extension y compris à basse pression.
- L'utilisation est particulièrement recommandée pour les pâturages, forêts, voies ferrées, terrains de golf et systèmes ATV sur moto quad.



Pack Blister 2 PCS



Part No.	Type	SPRAYING VOLUME (l/ha)													L m	H m		
		bar		psi		VMD l/min	@ 3,0 bar											
		2	3	4	5		4	6	8	10	12	14	16	18			20	
8259514	MX 008	2	30	EG	2,65	80	53	40	32	27	23	20	18	16	5,00	1,60		
		3	45	EG	3,30	99	66	50	40	33	28	25	22	20				
		4	60	EG	4,45	134	89	67	53	45	38	33	30	27				
		5	75	EG	4,95	149	99	74	59	50	42	37	33	30				
8259515	MX 010	2	30	EG	3,40	89	60	45	36	30	26	22	20	18	5,70	1,60		
		3	45	EG	4,10	108	72	54	43	36	31	27	24	22				
		4	60	EG	4,85	128	85	64	51	43	36	32	28	26				
8259516	MX 012	2	30	EG	3,80	98	66	49	39	33	28	25	22	20	5,80	1,60		
		3	45	EG	4,65	120	80	60	48	40	34	30	27	24				
		4	60	EG	5,35	138	92	69	55	46	40	35	31	28				
8259517	MX 015	2	30	EG	5,00	129	86	65	52	43	37	32	29	26	5,80	1,60		
		3	45	EG	6,00	155	103	78	62	52	44	39	34	31				
		4	60	EG	7,00	181	121	91	72	60	52	45	40	36				
8259518	MX 020	2	30	EG	6,50	157	105	79	63	52	45	39	35	31	6,20	1,60		
		3	45	EG	7,90	191	127	96	76	64	55	48	42	38				
		4	60	EG	9,60	232	155	116	93	77	66	58	52	46				
8259519	MX 024	2	30	EG	7,70	178	118	89	71	59	51	44	39	36	6,50	1,60		
		3	45	EG	9,60	222	148	111	89	74	63	55	49	44				
		4	60	EG	11,10	256	171	128	102	85	73	64	57	51				
8259520	MX 032	2	30	EG	10,10	233	155	117	93	78	67	58	52	47	6,50	1,60		
		3	45	EG	12,20	282	188	141	113	94	80	70	63	56				
		4	60	EG	13,80	318	212	159	127	106	91	80	71	64				
		5	75	EG	14,80	342	228	171	137	114	98	85	76	68				

Utilizzo / Use / Utilisation

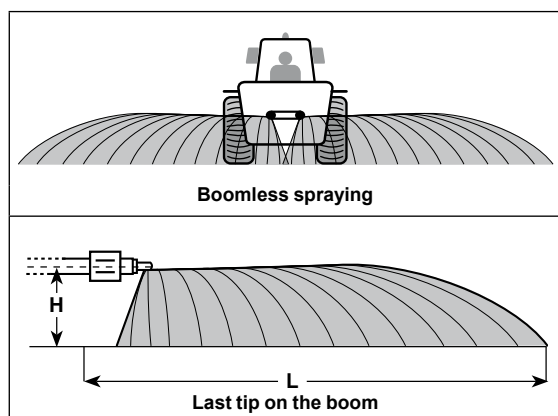

OPTIONALS

Part No.	Type	Pack
1 K00108006	Quick	2
8294020	G 3/8	
2 8294021	G 1/2	25
8294022	G 3/4	

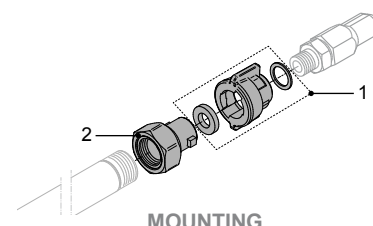

MOUNTING

Kit quad per ugelli MX

Quad kit for MX nozzles

Kit quad pour buses MX



Part No.	Pack
K00700013	1

OPTIONALS



Pag. 267

DIMENSIONS

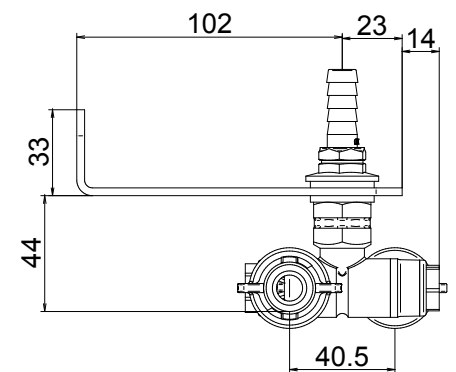

Utilizzo / Use / Utilisation

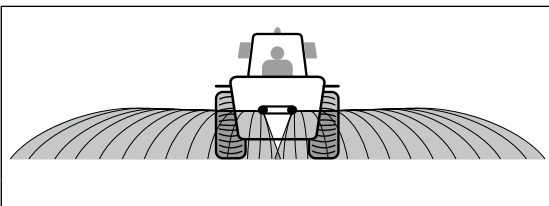

TKP



PLASTIC (POM)



SERIE DEFLETTORE POLIACETALE

Ugelli per uso a pieno campo senza induzione d'aria

Caratteristiche

- Ugello Deflettore resina acetalica;
- Angolo di 130° a 2.5 bar;
- Pressione consigliata da 1 a 3 bar;
- Dispone di un foro grande che ne facilita la pulizia e riduce gli intasamenti;
- Ottima resa nelle applicazioni di erbicidi sulla superficie totale con nebulizzatori costali.

POLYACETAL DEFLECTOR SERIES

Nozzles for full-field use without air induction

Features

- Acetal resin deflector nozzle;
- 130° angle at 2.5 bar;
- Pressure recommended ranges from 1 to 3 bar;
- This series has a big hole which facilitates cleaning and reduces clogging;
- Excellent yield in applying herbicides over the whole surface with nebulisers.

SÉRIE DÉFLECTEUR POLY-ACÉTAL

Buses pour utilisation en plein champ sans induction d'air

Caractéristiques

- Buse déflecteur en résine acétal.
- Angle de 130° à 2,5 bars.
- Pression recommandée de 1 à 3 bars.
- Trou de grande dimension qui en facilite le nettoyage et prévient l'obstruction.
- Excellent rendement dans les applications d'herbicides sur la superficie totale avec pulvérisateurs latéraux.



NOZZLE SPACING 1,00 m - SPRAYING VOLUME (l/ha)

Part No.	Type	Pressure		VMD l/min	Nozzle Spacing 1,00 m - Spraying Volume (l/ha)														
		bar	psi		4	5	6	7	8	9	10	12	14	16	18	20	25		
8259395	TKP 0,75	1	15	M	0,34	51	41	34	29	26	23	20	17	15	13	11	10	8	
		2	30	F	0,50	75	60	50	43	38	33	30	25	21	19	17	15	12	
		3,1	45	F	0,62	93	74	62	53	47	41	37	31	27	23	21	19	15	
8259396	TKP 1	1	15	M	0,46	69	55	46	39	35	31	28	23	20	17	15	14	11	
		2	30	F	0,68	102	82	68	58	51	45	41	34	29	26	23	20	16	
		3,1	45	F	0,84	126	101	84	72	63	56	50	42	36	32	28	25	20	
8259397	TKP 1,5	1	15	G	0,70	105	84	70	60	53	47	42	35	30	26	23	21	17	
		2	30	M	1,00	150	120	100	86	75	67	60	50	43	38	33	30	24	
		3,1	45	F	1,24	186	149	124	106	93	83	74	62	53	47	41	37	30	
8259398	TKP 2	1	15	G	1,19	179	143	119	102	89	79	71	60	51	45	40	36	29	
		2	30	M	1,32	198	158	132	113	99	88	79	66	57	50	44	40	32	
		3,1	45	F	1,60	240	192	160	137	120	107	96	80	69	60	53	48	38	
8259399	TKP 2,5	1	15	G	1,20	180	144	120	103	90	80	72	60	51	45	40	36	29	
		2	30	M	1,65	248	198	165	141	124	110	99	83	71	62	55	50	40	
		3,1	45	F	1,98	297	238	198	170	149	132	119	99	85	74	66	59	48	
8259400	TKP 3	1	15	G	1,53	230	184	153	131	115	102	92	77	66	57	51	46	37	
		2	30	M	2,00	300	240	200	171	150	133	120	100	86	75	67	60	48	
		3,1	45	F	2,45	368	294	245	210	184	163	147	123	105	92	82	74	59	
8259401	TKP 4	1	15	G	1,95	293	234	195	167	146	130	117	98	84	73	65	59	47	
		2	30	M	2,67	401	320	267	229	200	178	160	134	114	100	89	80	64	
		3,1	45	M	3,26	489	391	326	279	245	217	196	163	140	122	109	98	78	
8259402	TKP 5	1	15	G	2,35	353	282	235	201	176	157	141	118	101	88	78	71	56	
		2	30	M	3,25	488	390	325	279	244	217	195	163	139	122	108	98	78	
		3,1	45	M	3,97	596	476	397	340	298	265	238	199	170	149	132	119	95	
8259403	TKP 7,5	1	15	G	3,54	531	425	354	303	266	236	212	177	152	133	118	106	85	
		2	30	M	5,10	765	612	510	437	383	340	306	255	219	191	170	153	122	
		3,1	45	M	6,24	936	749	624	535	468	416	374	312	267	234	208	187	150	

OPTIONALS



Pag. 277

Pag. 238-239

8253113	green
8253114	blue
8253115	orange
8253116	brown
8253117	black

MCP



PLASTIC (POM)
CERAMIC



2÷6 bar

SERIE MCP CONO VUOTO – POLIACETALE
Ugelli per uso a pieno campo senza induzione d'aria

Caratteristiche

- Realizzati in resina acetica e ceramica;
- Pressione consigliata 2 a 6 bar;
- Angolo di 90°;
- Consente una copertura fogliare e una penetrazione eccellenti nel punto da irrorare;
- La serie MCP a CONO VUOTO può essere usata nei nebulizzatori a barre o per atomizzatori.

MCP SERIES EMPTY CONE – POLYACETAL
Nozzles for full-field use without air induction

Features

- Made in acetal resin and ceramic;
- Pressure recommended ranges from 2 to 6 bar;
- 90° angle;
- Provides excellent leaf coverage and penetration of the point sprayed;
- The EMPTY CONE MCP series can be used with mist blower booms or for atomisers.

SÉRIE MCP CÔNE VIDE – POLY-ACÉTAL
Buses pour utilisation en plein champ sans induction d'air

Caractéristiques

- Réalisées en résine d'acétal et céramique.
- Pression recommandée de 2 à 6 bars.
- Angle de 90°.
- Permet une excellente couverture foliaire et une excellente pénétration sur le point à traiter.
- La série MCP à CÔNE VIDE peut être utilisée sur les pulvérisateurs à barres ou sur les atomiseurs.



←0,50 m→
NOZZLE SPACING 0,50 m - SPRAYING VOLUME (l/ha)

Part No.	Type	bar		VMD	l/min	NOZZLE SPACING 0,50 m - SPRAYING VOLUME (l/ha)															
		psi	psi			4 Km/h	5 Km/h	6 Km/h	7 Km/h	8 Km/h	9 Km/h	10 Km/h	12 Km/h	14 Km/h	16 Km/h	18 Km/h	20 Km/h	25 Km/h			
8259388	MCP 0,5	2	30	F	0,18	54	43	36	31	27	24	22	18	15	14	12	121	9			
		3,1	45	F	0,22	66	53	44	38	33	29	26	22	19	17	15	147	11			
		4,1	60	F	0,25	75	60	50	43	38	33	30	25	21	19	17	168	12			
		5,2	75	F	0,28	84	67	56	48	42	37	34	28	24	21	19	188	13			
8259389	MCP 1	2	30	F	0,22	66	53	44	38	33	29	26	22	19	17	15	13	11			
		3,1	45	F	0,28	84	67	56	48	42	37	34	28	24	21	19	17	13			
		4,1	60	F	0,32	96	77	64	55	48	43	38	32	27	24	21	19	15			
		5,2	75	F	0,35	105	84	70	60	53	47	42	35	30	26	23	21	17			
8259390	MCP 1,5	2	30	F	0,30	90	72	60	51	45	40	36	30	26	23	20	18	14			
		3,1	45	F	0,37	111	89	74	63	56	49	44	37	32	28	25	22	18			
		4,1	60	F	0,43	129	103	86	74	65	57	52	43	37	32	29	26	21			
		5,2	75	F	0,48	144	115	96	82	72	64	58	48	41	36	32	29	23			
8259391	MCP 2	2	30	F	0,46	138	110	92	79	69	61	55	46	39	35	31	28	22			
		3,1	45	F	0,56	168	134	112	96	84	75	67	56	48	42	37	34	27			
		4,1	60	F	0,64	192	154	128	110	96	85	77	64	55	48	43	38	31			
		5,2	75	F	0,72	216	173	144	123	108	96	86	72	62	54	48	43	35			
8259392	MCP 3	2	30	F	0,64	192	154	128	110	96	85	77	64	55	48	43	38	31			
		3,1	45	F	0,77	231	185	154	132	116	103	92	77	66	58	51	46	37			
		4,1	60	F	0,88	264	211	176	151	132	117	106	88	75	66	59	53	42			
		5,2	75	F	0,99	297	238	198	170	149	132	119	99	85	74	66	59	48			
8259393	MCP 4	2	30	F	0,88	264	211	176	151	132	117	106	88	75	66	59	53	42			
		3,1	45	F	1,08	324	259	216	185	162	144	130	108	93	81	72	65	52			
		4,1	60	F	1,25	375	300	250	214	188	167	150	125	107	94	83	75	60			
		5,2	75	F	1,44	432	346	288	247	216	192	173	144	123	108	96	86	69			
					6,2	90	F	1,56	468	374	312	267	234	208	187	156	134	117	104	94	75

OPTIONALS



Pag. 277



Pag. 238-239

8253100	red
8253101	yellow
8253102	green
8253103	blue
8253104	orange
8253105	violet
8253106	black



PLASTIC (POM)



EZ



SERIE EZ - Ugelli per uso a pieno campo a induzione d'aria

Caratteristiche

- Getto piatto con aspirazione d'aria;
- Angolo di 110°;
- Pressione consigliata 3 a 8 bar;
- Potenziale di deriva estremamente basso persino alle pressioni più alte;
- Applicazione in colture a pieno campo e colture speciali.

EZ SERIES - Air induction nozzles for full-field use

Features

- Air-aspirating flat-spray tip.
- 110° angle
- Pressure recommended ranges from 3 to 8 bar;
- Extremely low drift potential, even for higher pressures;
- Application in field crops and special cultures.

SÉRIE EZ - Buses pour utilisation en plein champ à induction d'air

Caractéristiques

- Jet plat à aspiration d'air.
- Angle de 110°.
- Pression recommandée de 3 à 8 bars.
- Risque de dérive très faible y compris aux pressions les plus élevées.
- Application sur les cultures de plein champ et sur les cultures spéciales.



Part No.	Part No.	Type	Pressure		VMD	l/min	NOZZLE SPACING 0,50 m - SPRAYING VOLUME (l/ha)								
			bar	psi			5 Km/h	6 Km/h	7 Km/h	8 Km/h	10 Km/h	12 Km/h	14 Km/h	16 Km/h	18 Km/h
8261000	8259497	EZ 015	3	43,5	MG	0.59	142	118	101	89	71	59	51	44	39
			4	58	G	0.68	163	136	117	102	82	68	58	51	45
			5	72,5	G	0.76	182	152	130	114	91	76	65	57	51
			6	87	M	0.83	199	166	142	125	100	83	71	62	55
			7	101,5	M	0.90	216	180	154	135	108	90	77	68	60
8261001	8259498	EZ 02	3	43,5	MG	0.80	192	160	137	120	96	80	69	60	53
			4	58	G	0.92	221	184	158	138	110	92	79	69	61
			5	72,5	G	1.03	247	206	177	155	124	103	88	77	69
			6	87	G	1.13	271	226	194	170	136	113	97	85	75
			7	101,5	M	1.22	293	244	209	183	146	122	105	92	81
8261002	8259499	EZ 025	2	30	MG	0.81	194	162	139	122	97	81	69	61	54
			3	43,5	MG	0.99	238	198	170	149	119	99	85	74	66
			4	58	MG	1.15	276	230	197	173	138	115	99	86	77
			5	72,5	G	1.28	307	256	219	192	154	128	110	96	85
			6	87	M	1.40	336	280	240	210	168	140	120	105	93
8261003	8259500	EZ 03	2	30	EG	0.97	233	194	166	146	116	97	83	73	65
			3	43,5	EG	1.19	286	238	204	179	143	119	102	89	79
			4	58	G	1.37	329	274	235	206	164	137	117	103	91
			5	72,5	G	1.53	367	306	262	230	184	153	131	115	102
			6	87	G	1.68	403	336	288	252	202	168	144	126	112
8261004	8259501	EZ 04	7	101,5	M	1.81	434	362	310	272	217	181	155	136	121
			8	116	M	1.94	466	388	333	291	233	194	166	146	129
			3	43,5	EG	1.58	379	316	271	237	190	158	135	119	105
			4	58	G	1.82	437	364	312	273	218	182	156	137	121
			5	72,5	G	2.04	490	408	350	306	245	204	175	153	136
8261005	8259502	EZ 05	6	87	G	2.23	535	446	382	335	268	223	191	167	149
			7	101,5	M	2.41	578	482	413	362	289	241	207	181	161
			8	116	M	2.58	619	516	442	387	310	258	221	194	172
			2	30	EG	1.61	386	322	276	242	193	161	138	121	107
			3	43,5	MG	1.97	473	394	338	296	236	197	169	148	131
8261006	8259555	EZ 06	4	58	MG	2.28	547	456	391	342	274	228	195	171	152
			5	72,5	MG	2.55	612	510	437	383	306	255	219	191	170
			6	87	M	2.79	670	558	478	419	335	279	239	209	186
			7	101,5	M	3.01	722	602	516	452	361	301	258	226	201
			8	116	M	3.22	773	644	552	483	386	322	276	242	215
8261007	8259556	EZ 08	2	30	EG	1.93	463	386	331	290	232	193	165	145	129
			3	43,5	EG	2.36	566	472	405	354	283	236	202	177	157
			4	58	MG	2.73	655	546	468	410	328	273	234	205	182
			5	72,5	MG	3.05	732	610	523	458	366	305	261	229	203
			6	87	M	3.34	802	668	573	501	401	334	286	251	223
8261007	8259556	EZ 08	7	101,5	M	3.61	866	722	619	542	433	361	309	271	241
			8	116	M	3.86	926	772	662	579	463	386	331	290	257
			2	30	EG	2.58	619	516	442	387	310	258	221	194	172
			3	43,5	EG	3.16	758	632	542	474	379	316	271	237	211
			4	58	MG	3.65	876	730	626	548	438	365	313	274	243
8261007	8259556	EZ 08	5	72,5	MG	4.08	979	816	699	612	490	408	350	306	272
			6	87	MG	4.47	1073	894	766	671	536	447	383	335	298
			7	101,5	M	4.83	1159	966	828	725	580	483	414	362	322
			8	116	M	5.16	1238	1032	885	774	619	516	442	387	344

OPTIONALS



Pag. 277

Pag. 238-239

8253008	red
8253009	yellow
8253010	green
8253011	blue
8253056	orange
8253057	brown
8253049	black
8253120	grey
8253121	light blue



PLASTIC (POM)



1÷6 bar

EZK



Generalitat de Catalunya
Departament d'Agricultura
Alimentació i Acció Rural



SERIE EZK - Ugelli per uso a pieno campo a induzione d'aria

Caratteristiche

- Ugello a spruzzo piatto ad aspirazione d'aria
- Angolo di spruzzo: 110°
- Pressione consigliata 1 a 6 bar;
- Potenziale di deriva estremamente basso ed effetto di riduzione delle perdite nell'intervallo di pressione fino a 3,0 bar.

EZK SERIES

Air induction nozzles for full-field use

Features

- Air-aspirating flat-spray tip;
- Spray angle: 110°
- Pressure recommended ranges from 1 to 6 bar;
- Extremely low drift potential and loss-reducing effect in pressure range up to 3.0 bar.

SÉRIE EZK

Buses pour utilisation en plein champ à induction d'air

Caractéristiques

- Buse à jet plat à aspiration d'air.
- Angle de pulvérisation : 110°.
- Pression recommandée de 1 à 6 bars.
- Risque de dérive très faible et effet de réduction des fuites sur l'intervalle de pression jusqu'à 3 bars.

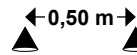

NOZZLE SPACING 0,50 m - SPRAYING VOLUME (l/ha)

Part No.	Part No.	Type	bar		psi		VMD l/min	5		6		7		8		10		12		14		16		18																																																																																																																																																																																																																																																																																																																																																																																																																																																																																																																																																																																																																																																																																																																																																																																																																																																																																														
			1	2	3	4		5	6	7	8	10	12	14	16	18	20	25	30	35	40	45	50	55	60	65	70																																																																																																																																																																																																																																																																																																																																																																																																																																																																																																																																																																																																																																																																																																																																																																																																																																																																																											
8261008	8259491	EZK 110/015	1,5	21,8	G	0,42	101	84	72	63	50	42	36	32	28	2,5	36,3	M	0,54	130	108	93	81	65	54	46	41	36	3	43,5	M	0,59	142	118	101	89	71	59	51	44	39	4	58	M	0,63	151	126	108	95	76	63	54	47	42	4,5	65,3	M	0,72	173	144	123	108	86	72	62	54	48	5	72,5	M	0,76	182	152	130	114	91	76	65	57	51	6	87	M	0,83	199	166	142	125	100	83	71	62	55	1,5	21,8	G	0,56	134	112	96	84	67	56	48	42	37	2	30	G	0,65	156	130	111	98	78	65	56	49	43	2,5	36,3	G	0,73	175	146	125	110	88	73	63	55	49	3	43,5	G	0,80	192	160	137	120	96	80	69	60	53	3,5	50,8	M	0,86	206	172	147	129	103	86	74	65	57	4	58	M	0,92	221	184	158	138	110	92	79	69	61	4,5	65,3	M	0,98	235	196	168	147	118	98	84	74	65	5	72,5	M	1,03	247	206	177	155	124	103	88	77	69	6	87	M	1,13	271	226	194	170	136	113	97	85	75	1,5	21,8	MG	0,70	168	140	120	105	84	70	60	53	47	2	30	MG	0,81	194	162	139	122	97	81	69	61	54	2,5	36,3	G	0,91	218	182	156	137	109	91	78	68	61	3	43,5	G	0,99	238	198	170	149	119	99	85	74	66	3,5	50,8	G	1,07	257	214	183	161	128	107	92	80	71	4	58	G	1,15	276	230	197	173	138	115	99	86	77	4,5	65,3	M	1,22	293	244	209	183	146	122	105	92	81	5	72,5	M	1,28	307	256	219	192	154	128	110	96	85	6	87	M	1,40	336	280	240	210	168	140	120	105	93	1,5	21,8	MG	0,84	202	168	144	126	101	84	72	63	56	2	30	MG	0,97	233	194	166	146	116	97	83	73	65	2,5	36,3	MG	1,08	259	216	185	162	130	108	93	81	72	3	43,5	G	1,19	286	238	204	179	143	119	102	89	79	3,5	50,8	G	1,28	307	256	219	192	154	128	110	96	85	4	58	G	1,37	329	274	235	206	164	137	117	103	91	4,5	65,3	G	1,46	350	292	250	219	175	146	125	110	97	5	72,5	G	1,53	367	306	262	230	184	153	131	115	102	6	87	M	1,68	403	336	288	252	202	168	144	126	112	1	14,5	MG	0,91	218	182	156	137	109	91	78	68	61	1,5	21,8	MG	1,12	269	224	192	168	134	112	96	84	75	2	30	MG	1,29	310	258	221	194	155	129	111	97	86	2,5	36,3	MG	1,44	346	288	247	216	173	144	123	108	96	3	43,5	MG	1,58	379	316	271	237	190	158	135	119	105	3,5	50,8	G	1,71	410	342	293	257	205	171	147	128	114	4	58	G	1,82	437	364	312	273	218	182	156	137	121	4,5	65,3	G	1,94	466	388	333	291	233	194	166	146	129	5	72,5	G	2,04	490	408	350	306	245	204	175	153	136	6	87	M	2,23	535	446	382	335	268	223	191	167	149	1	14,5	EG	1,14	274	228	195	171	137	114	98	86	76	1,5	21,8	EG	1,39	324	278	238	209	167	139	119	104	93	2	30	MG	1,61	386	322	276	242	193	161	138	121	107	2,5	36,3	MG	1,80	432	360	309	270	216	180	154	135	120	3	43,5	MG	1,97	473	394	338	296	236	197	169	148	131	3,5	50,8	G	2,13	511	426	365	320	256	213	183	160	142	4	58	G	2,28	547	456	391	342	274	228	195	171	152	4,5	65,3	G	2,42	581	484	415	363	290	242	207	182	161	5	72,5	G	2,55	612	510	437	383	306	255	219	191	170	6	87	M	2,79	670	558	478	419	335	279	239	209	186	2	30	EG	1,93	463	386	331	290	232	193	165	145	129	3	43,5	EG	2,36	566	472	405	354	283	236	202	177	157	4	58	MG	2,73	655	546	468	410	328	273	234	205	182	5	72,5	MG	3,05	732	610	523	458	366	305	261	229	203	6	87	MG	3,34	802	668	573	501	401	334	286	251	223	7	101,5	M	3,61	866	722	619	542	433	361	309	271	241	8	116	M	3,86	926	772	662	579	463	386	331	290	257	2	30	MG	2,58	619	516	442	387	310	258	221	194	172	3	43,5	MG	3,16	758	632	542	474	379	316	271	237	211	4	58	G	3,65	876	730	626	548	438	365	313	274	243	5	72,5	G	4,08	979	816	699	612	490	408	350	306	272	6	87	G	4,47	1073	894	766	671	536	447	383	335	298	7	101,5	M	4,83	1159	966	828	725	580	483	414	362	322	8	116	M	5,16	1238	1032	885	774	619	516	442	387	344

OPTIONALS



Pag. 277

Pag. 238-239

8253000	red
8253001	yellow
8253002	green
8253003	blue
8253041	white
8253042	orange
8253043	brown
8253048	black
8253118	grey
8253119	violet

EZK TWIN



PLASTIC (POM)



SERIE EZK-TWIN

Ugelli per uso a pieno campo a induzione d'aria

Caratteristiche

- Getto piatto con aspirazione d'aria, decentrato, usato in punta di barra;
- Angolo di spruzzo: 110°
- Pressione consigliata 1 a 6 bar;
- Usato in applicazioni a banda stretta o altre complementari con barra quali ad esempio fertilizzanti liquidi.

EZK-TWIN SERIES

Air induction nozzles for full-field use

Features

- Flat, offset air induction jet used on the boom tip;
- Spray angle: 110°
- Pressure recommended ranges from 1 to 6 bar;
- Used for narrow strip applications or other accessories with boom, such as, for example liquid fertilisers.

SÉRIE EZK-TWIN

Buses pour utilisation en plein champ à induction d'air

Caractéristiques

- Jet plat avec aspiration d'air et décentré, utilisé sur extrémité de barre.
- Angle de pulvérisation : 110°.
- Pression recommandée de 1 à 6 bars.
- Série utilisée pour applications à bande étroite ou autres applications complémentaires avec barre, par exemple pour fertilisants liquides.

Part No.	Part No.	Type	NOZZLE SPACING 0,50 m - SPRAYING VOLUME (l/ha)												
			bar	psi	l/min	5 Km/h	6 Km/h	7 Km/h	8 Km/h	10 Km/h	12 Km/h	14 Km/h	16 Km/h	18 Km/h	
8261016	8259503	EZK TWIN 110/02	1,5	21,8	0,56	134	112	96	84	67	56	48	42	37	
			2	30	0,65	156	130	111	98	78	65	56	49	43	
			2,5	36,3	0,73	175	146	125	110	88	73	63	55	49	
			3	43,5	0,80	192	160	137	120	96	80	69	60	53	
			3,5	50,8	0,86	206	172	147	129	103	86	74	65	57	
			4	58	0,92	221	184	158	138	110	92	79	69	61	
8261017	8259504	EZK TWIN 110/025	4,5	65,3	0,98	235	196	168	147	118	98	84	74	65	
			5	72,5	1,03	247	206	177	155	124	103	88	77	69	
			6	87	1,13	271	226	194	170	136	113	97	85	75	
			1,5	21,8	0,70	168	140	120	105	84	70	60	53	47	
			2	30	0,81	194	162	139	122	97	81	69	61	54	
			2,5	36,3	0,91	218	182	156	137	109	91	78	68	61	
8261018	8259505	EZK TWIN 110/03	3	43,5	0,99	238	198	170	149	119	99	85	74	66	
			3,5	50,8	1,07	257	214	183	161	128	107	92	80	71	
			4	58	1,15	276	230	197	173	138	115	99	86	77	
			4,5	65,3	1,22	293	244	209	183	146	122	105	92	81	
			5	72,5	1,28	307	256	219	192	154	128	110	96	85	
			6	87	1,40	336	280	240	210	168	140	120	105	93	
8261019	8259506	EZK TWIN 110/04	1,5	21,8	0,84	202	168	144	126	101	84	72	63	56	
			2	30	0,97	233	194	166	146	116	97	83	73	65	
			2,5	36,3	1,08	259	216	185	162	130	108	93	81	72	
			3	43,5	1,19	286	238	204	179	143	119	102	89	79	
			3,5	50,8	1,28	307	256	219	192	154	128	110	96	85	
			4	58	1,37	329	274	235	206	164	137	117	103	91	
8261055	8259580	EZK TWIN 110/05	4,5	65,3	1,46	350	292	250	219	175	146	125	110	97	
			5	72,5	1,53	367	306	262	230	184	153	131	115	102	
			6	87	1,68	403	336	288	252	202	168	144	126	112	
			1	14,5	0,91	218	182	156	137	109	91	78	68	61	
			1,5	21,8	1,12	269	224	192	168	134	112	96	84	75	
			2	30	1,29	310	258	221	194	155	129	111	97	86	
8261056	8259581	EZK TWIN 110/06	2,5	36,3	1,44	346	288	247	216	173	144	123	108	96	
			3	43,5	1,58	379	316	271	237	190	158	135	119	105	
			3,5	50,8	1,71	410	342	293	257	205	171	147	128	114	
			4	58	1,82	437	364	312	273	218	182	156	137	121	
			4,5	65,3	1,94	466	388	333	291	233	194	166	146	129	
			5	72,5	2,04	490	408	350	306	245	204	175	153	136	
8261055	8259580	EZK TWIN 110/05	6	87	2,23	535	446	382	335	268	223	191	167	149	
			1	14,5	1,14	274	228	195	171	137	114	98	86	76	
			1,5	21,8	1,39	334	278	238	209	167	139	119	104	93	
			2	30	1,61	386	322	276	242	193	161	138	121	107	
			2,5	36,3	1,80	432	360	309	270	216	180	154	135	120	
			3	43,5	1,97	473	394	338	296	236	197	169	148	131	
8261056	8259581	EZK TWIN 110/06	3,5	50,8	2,13	511	426	365	320	256	213	183	160	142	
			4	58	2,28	547	456	391	342	274	228	195	171	152	
			4,5	65,3	2,42	581	484	415	363	290	242	207	182	161	
			5	72,5	2,55	612	510	437	383	306	255	219	191	170	
			6	87	2,79	670	558	478	419	335	279	239	209	186	
			2	30	1,93	463	386	331	290	232	193	165	145	129	
8261056	8259581	EZK TWIN 110/06	3	43,5	2,36	566	472	405	354	283	236	202	177	157	
			4	58	2,73	655	546	468	410	328	273	234	205	182	
			5	72,5	3,05	732	610	523	458	366	305	261	229	203	
			6	87	3,34	802	668	573	501	401	334	286	251	223	
			7	101,5	3,61	866	722	619	542	433	361	309	271	241	
			8	116	3,86	926	772	662	579	463	386	331	290	257	



OPTIONALS



Pag. 277



Pag. 238-239

8253000	red
8253001	yellow
8253002	green
8253003	blue
8253041	white
8253042	orange
8253043	brown
8253048	black
8253118	grey
8253119	violet

RS



PLASTIC (POM)



2÷4 bar

SERIE RS - Ugelli per uso a pieno campo senza induzione d'aria

Caratteristiche

- Realizzati in resina acetilica
- Pressione consigliata da 2 a 4 bar
- Angolo di 80° o 110°;
- Indicatore per erbicidi, insetticidi e fungicidi.

RS SERIES - Nozzles for full-field use without air induction

Features

- Made in acetal resin;
- Pressure recommended ranges from 2 to 4 bar;
- 80° or 110° angle;
- Suitable for herbicides, insecticides and fungicides.

SÉRIERS - Buses pour utilisation en plein champ sans induction d'air

Caractéristiques

- Réalisées en résine d'acétal
- Pression recommandée de 2 à 4 bars.
- Angle de 80° ou 110°.
- Indiquées pour herbicides, insecticides et fongicides.

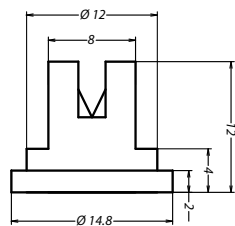

← 0,50 m →
SPRAYING VOLUME (l/ha)

Part No.	Part No.	Type	bar		VMD	SPRAYING VOLUME (l/ha)													
			psi	F		0,32	4	5	6	7	8	9	10	12	14	16	18	20	25
8261020 8261021	8259507 8259521	110-01 80-01	2	30	F	0,32	96	76,8	64	54,9	48	38,4	32	24	21,3	19,2	15,4	12,8	11
			2,5	36	F	0,36	108	86,4	72	61,7	54	43,2	36	27	24	21,6	17,3	14,4	12,3
			3	43	F	0,39	117	93,6	78	66,9	58,5	46,8	39	29,3	26	23,4	18,7	15,6	13,4
			3,5	5,1	F	0,42	126	101	84	72	63	50,4	42	31,5	28	25,2	20,2	16,8	14,4
8261022 8261023	8259508 8259522	110-015 80-015	2	30	F	0,48	144	115	96	82,3	72	57,6	48	36	32	28,8	23	19,2	16,5
			2,5	36	F	0,54	162	130	108	92,6	81	64,8	54	40,5	36	32,4	25,9	21,6	18,5
			3	43	F	0,59	177	142	118	101	88,5	70,8	59	44,3	39,3	35,4	28,3	23,6	20,2
			3,5	5,1	F	0,64	192	154	128	110	96	76,8	64	48	42,7	38,4	30,7	25,6	21,9
8261024 8261025	8259509 8259523	110-02 80-02	2	30	F	0,65	195	156	130	111	97,5	78	65	48,8	43,3	39	31,2	26	22,3
			2,5	36	F	0,72	216	173	144	123	108	86,4	72	54	48	43,2	34,6	28,8	24,7
			3	43	F	0,79	237	190	158	135	119	94,8	79	59,3	52,7	47,4	37,9	31,6	27,1
			3,5	5,1	F	0,85	255	204	170	146	128	102	85	63,8	56,7	51	40,8	34	29,1
8261026 8261027	8259510 8259524	110-03 80-03	2	30	F	0,96	288	230	192	165	144	115	96	72	64	57,6	46,1	38,4	32,9
			2,5	36	F	1,08	324	259	216	185	162	130	108	81	72	64,8	51,8	43,2	37
			3	43	F	1,18	354	283	236	202	177	142	118	88,5	78,7	70,8	56,6	47,2	40,5
			3,5	5,1	F	1,27	381	305	254	218	191	152	127	95,3	84,7	76,2	61	50,8	43,5
8261028 8261029	8259511 8259525	110-04 80-04	2	30	F	1,29	387	310	258	221	194	155	129	96,8	86	77,4	61,9	51,6	44,2
			2,5	36	F	1,44	432	346	288	247	216	173	144	108	96	86,4	69,1	57,6	49,4
			3	43	F	1,58	474	379	316	271	237	190	158	119	105	94,8	75,8	63,2	54,2
			3,5	5,1	F	1,71	513	410	342	293	257	205	171	128	114	103	82,1	68,4	58,6
8261030 8261031	8259512 8259526	110-05 80-05	2	30	M	1,61	483	386	322	276	242	193	161	121	107	96,6	77,3	64,4	55,2
			2,5	36	M	1,8	540	432	360	309	270	216	180	135	120	108	86,4	72	61,7
			3	43	M	1,97	591	473	394	338	296	236	197	148	131	118	94,6	78,8	67,5
			3,5	5,1	M	2,13	639	511	426	365	320	256	213	160	142	128	102	85,2	73
8261032 8261033	8259513 8259527	110-06 80-06	2	30	M	1,94	582	466	388	333	291	233	194	146	129	116	93,1	77,6	66,5
			2,5	36	M	2,16	648	518	432	370	324	259	216	162	144	130	104	86,4	74,1
			3	43	M	2,37	711	569	474	406	356	284	237	178	158	142	114	94,8	81,3
			3,5	5,1	M	2,56	768	614	512	439	384	307	256	192	171	154	123	102	87,8
8261034 8261035	8259548 8259549	110-08 80-08	2	30	G	2,58	774	619	516	442	387	310	258	194	172	155	124	103	88,5
			2,5	36	G	2,88	864	691	576	494	432	346	288	216	192	173	138	115	98,7
			3	43	G	3,16	948	758	632	542	474	379	316	237	211	190	152	126	108
			3,5	5,1	M	3,41	1023	818	682	585	512	409	341	256	227	205	164	136	117
8261036 8261037	8259550 8259551	110-10 80-10	2	30	G	3,23	969	775	646	554	485	388	323	242	215	194	155	129	111
			3	43	G	3,95	1185	948	790	677	593	474	395	296	263	237	190	158	135
			4	58	G	4,56	1368	1094	912	782	684	547	456	342	304	274	219	182	156
			2	30	G	4,83	1449	1159	966	828	725	580	483	362	322	290	232	193	166
8261038 8261039	8259552 8259553	110-15 80-15	3	43	G	5,92	1776	1421	1184	1015	888	710	592	444	395	355	284	237	203
			4	58	G	6,84	2052	1642	1368	1173	1026	821	684	513	456	410	328	274	235
			2	30	G	6,44	1932	1546	1288	1104	966	773	644	483	429	386	309	258	221
			3	43	G	7,89	2367	1894	1578	1353	1184	947	788	592	526	473	379	316	271
8261040	8259554	110-20	4	58	G	9,11	2733	2186	1822	1562	1367	1093	911	683	607	547	437	364	312

OPTIONALS



Pag. 277



Pag. 238-239

8253000	red
8253001	yellow
8253002	green
8253003	blue
8253041	white
8253042	orange
8253043	brown
8253048	black
8253118	grey
8253119	violet

KR5



PLASTIC (POM)



SERIE KR5

Caratteristiche

- Ugello a spruzzo piatto
 - Angolo di spruzzo: 60°
 - Pressione consigliata 2 a 5 bar
 - Potenziale di deriva estremamente basso ed effetto di riduzione delle perdite nell'intervallo di pressione fino a 3,0 bar.
- I valori specificati in tabella si ritengono validi per una concentrazione di prodotto al 32%.

KR5 SERIES

Features

- Flat-spray tip
 - Spray angle: 60°
 - Pressure recommended ranges from 2 to 5 bar
 - Extremely low drift potential and loss-reducing effect in pressure range up to 3.0 bar.
- The indicated values in chart are valid for a product concentration of 32%.

SERIES KR5

Caractéristiques:

- Buse au jet plat
 - Angle de pulvérisation: 60°
 - Pression recommandée entre 2 et 5 bar
 - Potentiel de dérive extrêmement faible et réduction des pertes de pression jusqu'à 3,0 bar.
- Les valeurs indiquées dans le tableau sont valables pour une concentration de produit à 32%.

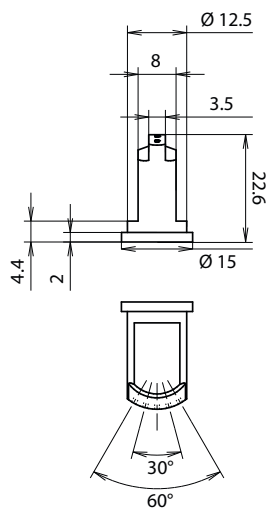

← 0,50 m →
NOZZLE SPACING 0,50 m - SPRAYING VOLUME (l/ha)

Part No.	Type	bar	psi	l/min	6 Km/h	7 Km/h	8 Km/h	10 Km/h
8259572	KR5 60/02	2	30	0.65	113	97	85	68
		3	43,5	0.80	139	119	104	83
		4	58	0.92	160	137	120	96
		5	72,5	1.03	179	153	134	106
8259573	KR5 60/025	2	30	0.81	141	120	106	84
		3	43,5	0.99	172	148	130	103
		4	58	1.15	200	171	150	120
		5	72,5	1.28	222	190	167	134
8259574	KR5 60/03	2	30	0.97	163	144	122	94
		3	43,5	1.19	205	177	153	123
		4	58	1.37	234	204	176	140
		5	72,5	1.53	262	227	197	157
8259575	KR5 60/04	2	30	1.29	221	192	166	132
		3	43,5	1.58	276	235	208	166
		4	58	1.82	307	271	231	184
		5	72,5	2.04	351	304	263	210
8259576	KR5 60/05	2	30	1.61	271	240	206	165
		3	43,5	1.97	339	294	254	203
		4	58	2.28	387	340	291	233
		5	72,5	2.55	438	380	328	262
8259577	KR5 60/06	2	30	1.93	334	289	250	200
		3	43,5	2.36	410	353	308	246
		4	58	2.73	480	409	360	288
		5	72,5	3.05	530	456	398	318
8259578	KR5 60/08	2	30	2.58	449	384	337	269
		3	43,5	3.16	550	471	412	329
		4	58	3.65	635	544	476	381
		5	72,5	4.08	710	608	532	426

OPTIONALS



Pag. 277

Pag. 238-239

8253000	red
8253001	yellow
8253002	green
8253003	blue
8253041	white
8253042	orange
8253043	brown
8253048	black
8253118	grey
8253119	violet



Ugello in ottone a ventaglio 110°

Brass flat nozzles 110°

Buses à fente en laiton 110°



Part No.	Ø mm	Portata (l/min) - Flow rate													Pack		
		0,5 bar	0,7 bar	1 bar	1,5 bar	2 bar	3 bar	4 bar	5 bar	6 bar	7 bar	10 bar	15 bar	20 bar		35 bar	
01	8259134	0,66	0,15	0,18	0,23	0,27	0,32	0,39	0,46	0,5	0,55	0,6	0,7	0,9	1	1,3	25
015	8259135	0,79	0,24	0,3	0,34	0,43	0,48	0,59	0,58	0,76	0,83	0,9	1,1	1,3	1,5	2	
02	8259136	0,91	0,31	0,38	0,45	0,55	0,64	0,78	0,9	1	1,1	1,2	1,5	1,8	2	2,7	
03	8259137	1,1	0,48	0,55	0,68	0,85	0,96	1,2	1,36	1,5	1,7	1,8	2,1	2,6	3	4	
04	8259138	1,3	0,64	0,75	0,9	1,1	1,3	1,6	1,8	2	2,2	2,4	2,9	3,5	4	5,3	

Ugello in ottone a ventaglio eccentrico

Off-centre brass flat nozzles

Buse à fente excentré en laiton



Nozzle mm	Part No.	bar	l/min'	L (cm)	H = 45 cm			L (cm)	H = 60 cm			Pack
					l/ha in Km / h	5	6		8	l/ha in Km / h	5	
Ø 0,91	8259139	2	0,65	170	45	37	28	190	41	34	25	25
		3	0,79	175	54	45	33	195	49	40	30	
		4	0,91	180	60	50	38	198	55	46	35	
Ø 1,09	8259140	2	0,97	195	59	50	37	205	57	48	36	
		3	1,18	200	70	58	44	210	68	56	42	
		4	1,37	208	79	66	49	215	76	64	48	
Ø 1,32	8259141	2	1,29	230	67	56	42	235	66	55	41	
		3	1,58	235	80	67	50	238	80	66	50	
		4	1,82	238	92	77	57	240	91	76	57	
Ø 1,57	8259142	2	1,93	250	92	77	58	274	85	71	53	
		3	2,37	255	111	93	69	280	102	85	64	
		4	2,74	260	127	106	79	282	117	97	73	
Ø 1,83	8259180	2	2,58	254	122	102	76,2	279	111	92,5	69,4	
		3	3,16	259	146	122	91,5	284	133	111	83,5	
		4	3,65	264	166	138	104	287	153	127	95,4	

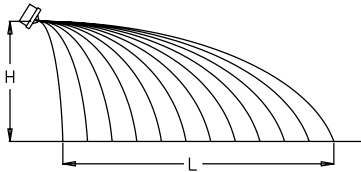

Piastrina in acciaio inox a cono ø 15 mm
Stainless steel disc cone ø 15 mm
Pastille à cône en acier inox ø 15 mm



Part No.	Ø mm	Pack
8259143	1	100
8259144	1,2	
8259145	1,5	
8259146	1,8	
8259147	2	

Convogliatore in acciaio inox ø 15 mm
Stainless steel core ø 15 mm
Diffuseur en acier inox ø 15 mm



Part No.	Ø mm	Pack
8259148	blank	100
8259237	1,2	
8259337	1,5	
8259338	1,8	

Guarnizione per piastrina inox ø 15 mm
Gasket for s/s core ø 15 mm
Joint pour pastille inox ø 15 mm



Part No.	Pack
G00002032	100

Piastrina in ceramica ø 15 mm
Ceramic disc ø 15 mm
Pastille en céramique ø 15 mm



Part No.	Ø mm	Pack
8259167	0,8	100
8259168	1,0	
8259169	1,2	
8259170	1,5	
8259171	1,8	
8259172	2,0	

FILTERS

Filtri per ugelli

Nozzle filters

Filtres pour buses

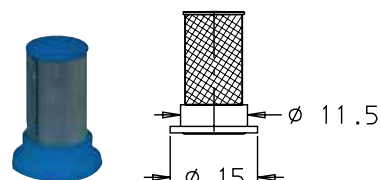
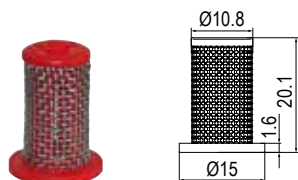

Part No.	Screen MESH	Pack
8139017	30 MESH	10
8139018	50 MESH	
8139019	80 MESH	
8139020	100 MESH	
8139021	120 MESH	

PACK



Clamshell
PCS 10

Part No.	Screen MESH	Pack
8139002	50 MESH	50
8139003	100 MESH	

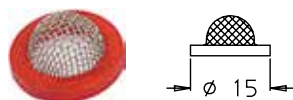

Part No.	Screen MESH	Pack
8139000	32 MESH	50
8139001	50 MESH	
8139016	100 MESH	

Part No.	Screen MESH	Pack
8139022	25 MESH	50
8139023	50 MESH	50
8139024	80 MESH	50

Filtri per ugelli con antigoccia a sfera

Nozzle filters with ball check-valve

Filtres pour buses avec antigoutte à sphère

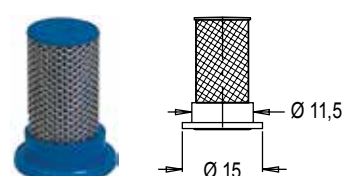
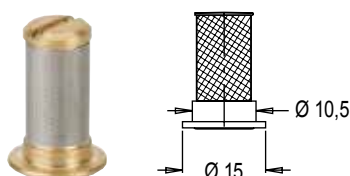

Part No.	Screen MESH	Pack
8139009	50 MESH	50
8139010	100 MESH	

Part No.	Screen MESH	Pack
8139004	50 MESH	50
8139005	100 MESH	
8139013	200 MESH	

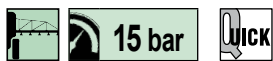

Portaugello snodato femmina - attacco rapido.
Swivel female nozzle holder - quick-fitting.
Porte-buse articulé femelle - raccord rapide.

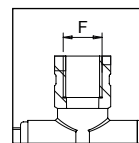

Part No.	F	Pack
8247011	G 1/4" F	
8247012	NPT 1/4" F	25
8247013	G 3/8" F	



Portaugello snodato femmina - girello G 3/8".
Swivel female nozzle holder - BSP 3/8" fly nut.
Porte-buse articulé femelle - écrou G 3/8".

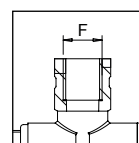

Part No.	F	Pack
8247017	G 1/4" F	
8247018	NPT 1/4" F	25
8247019	G 3/8" F	

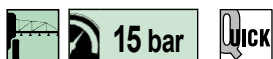

Portaugello snodato doppio femmina - attacco rapido.
Double swivel female nozzle holder - quick-fitting.
Porte-buse articulé femelle "2 sorties" - raccord rapide.

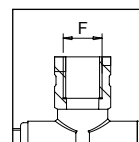

Part No.	F	Pack
8247014	G 1/4" F	
8247015	NPT 1/4" F	25
8247016	G 3/8" F	



Portaugello snodato doppio femmina - girello G 3/8".
Double swivel female nozzle holder - BSP 3/8" fly nut.
Porte-buse articulé femelle "2 sorties" - écrou G 3/8".

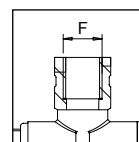

Part No.	F	Pack
8247020	G 1/4" F	
8247021	NPT 1/4" F	25
8247022	G 3/8" F	

Portaugelli snodati in ottone nichelato per barre interfilari e per uso industriale. Tenute in NBR. Ugelli non compresi.

Brass galvanised swivel nozzle holders for interline booms and industrial applications. NBR gaskets. Nozzles not included.

Porte-buses articulés entre rangs en laiton pour rampes de désherbage et l'industrie. Joints en NBR. Buses non fournies.



Portaugello snodato maschio con girello G3/8".
Swivel male nozzle holder with 3/8" fly nut.
Porte-buse mâle avec écrou 3/8" GAZ.



Part No.	F2	Pack
8247003	G 1/4" M	10



Portaugello snodato femmina con girello 3/8".
Swivel female nozzle holder with BSP 3/8" fly nut.
Porte-buse femelle avec écrou 3/8" GAZ.



Part No.	F	Pack
8247004	G 1/4" F	
8247005	NPT 1/4" F	10
8247006	Ø12x19 F	



Portaugello snodato doppio maschio con girelli G3/8".
Double swivel male nozzle holders with fly nuts BSP 3/8".
Porte-buse articulé mâle "2 sorties" avec écrou 3/8" GAZ.



Part No.	F	Pack
8247007	G 1/4" M	10



Portaugello doppio femmina con girelli G3/8".
Double swivel female nozzle holder with fly nuts BSP 3/8".
Porte-buse articulé femelle "2 sorties" avec écrou 3/8" GAZ.



Part No.	F	Pack
8247008	G 1/4" F	
8247009	NPT 1/4" F	10
8247010	Ø12x19 F	

SPARE PARTS



Part No.	for NOZZLE	Pack
8304026	ATR/TR	10

OPTIONALS



Pag. 246-274

Portaugello fisso completo di o-ring di tenuta e girello 3/8". Per tubi Ø 20mm (1/2").

Fixed nozzle holder with o-ring gasket and 3/8" fly nut. For rods of Ø 20mm (1/2").

Porte-buse avec joint torique et écrou 3/8". Pour tuyaux de Ø 20mm (1/2").



Part No.	F mm	D mm	Pack
8272004	7	20 (1/2")	25

DIMENSIONS

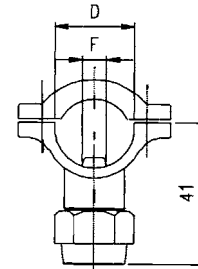

SPARE PARTS



Part No.	for NOZZLE	Pack
8304026	ATR/TR	10

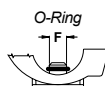

Part No.	F mm	Pack
G00001006	7	50

OPTIONALS



Pag. 246-274

Portaugello fisso con cavallotto filettato, o-ring di tenuta e girello 3/8". Per tubi Ø 20 mm (1/2").

Fixed nozzle holder with o-ring gasket and 3/8" fly nut. Mounting hole of M8. For rods of Ø 20mm (1/2").

Porte-buse avec joint torique et écrou 3/8". Trou de fixation. Pour tuyaux de Ø 20mm (1/2").



Part No.	F mm	F1	D mm	Pack
8272005	7	M8	20 (1/2")	25

DIMENSIONS

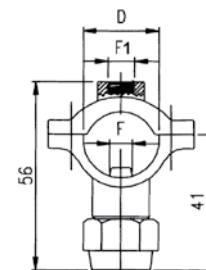

SPARE PARTS



Part No.	for NOZZLE	Pack
8304026	ATR/TR	10

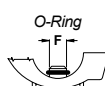

Part No.	F mm	Pack
G00001006	7	50

OPTIONALS



Pag. 246-274

Portaugello fisso.

Fixed nozzle holder.

Porte-buse fixe.



Part No.	F	Pack
8249000	1/8" M	25



Part No.	F	Pack
8249001	1/4" M	25

SPARE PARTS



Part No.	for NOZZLE	Pack
8304026	ATR/TR	10

OPTIONALS



Pag. 246-274

Tubi di calata.

Hose drips.

Pendillards

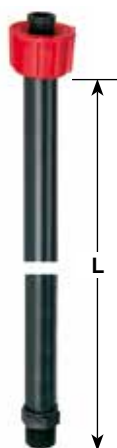

Part No.	L mm	Type	Pack
8251000	380	QUICK	10
8251001	380	G 3/8"	
8251002	610	QUICK	
8251003	610	G 3/8"	

LEGENDA

Campo di impiego / Use / Utilisation



Per macchine a basso volume
For low-volume spraying machines
Pour machines basse volum



Per macchine da diserbo
For crop sprayers
Pour pulvérisateurs



Per atomizzatori
For orchard sprayers
Pour atomiseurs

Accessori opzionali *Optionals* *Accessoires optionals*



Protezione per barre interfilari
Shield for interline booms
Cache-rampe entre rangs



Protezione antideriva
Drift Protection
Protection anti-dérive



Terminale per barre interfilari
Boom end nozzle protectors
Porte buse escamotable pour rampe entre rangs

BARRE INTERFILARI

VINEYARD SPRAY BOOMS/ RAMPES DE PULVÉRISATION

6A

Barre interfilari

Struttura metallica zincata, aste portaugello in acciaio inox, cofani di protezione in PLT, getti snodati in ottone, ugelli in resina acetaleica, pistoni idraulici senza tubi di collegamento.

Vineyard spray booms

Galvanized structure, rods in stainless steel, protective cases in PLT, brass swivel nozzle bodies, acetalic resin nozzles, hydraulic pistons without connection pipes.

Rampes de pulvérisation

Structure métallique galvanisée, barres porte-buses en acier INOX, coffres de protection en PLT, corps porte-buses en laiton orientables, buses en résine acétalique, pistons hydrauliques sans tuyaux de connection.

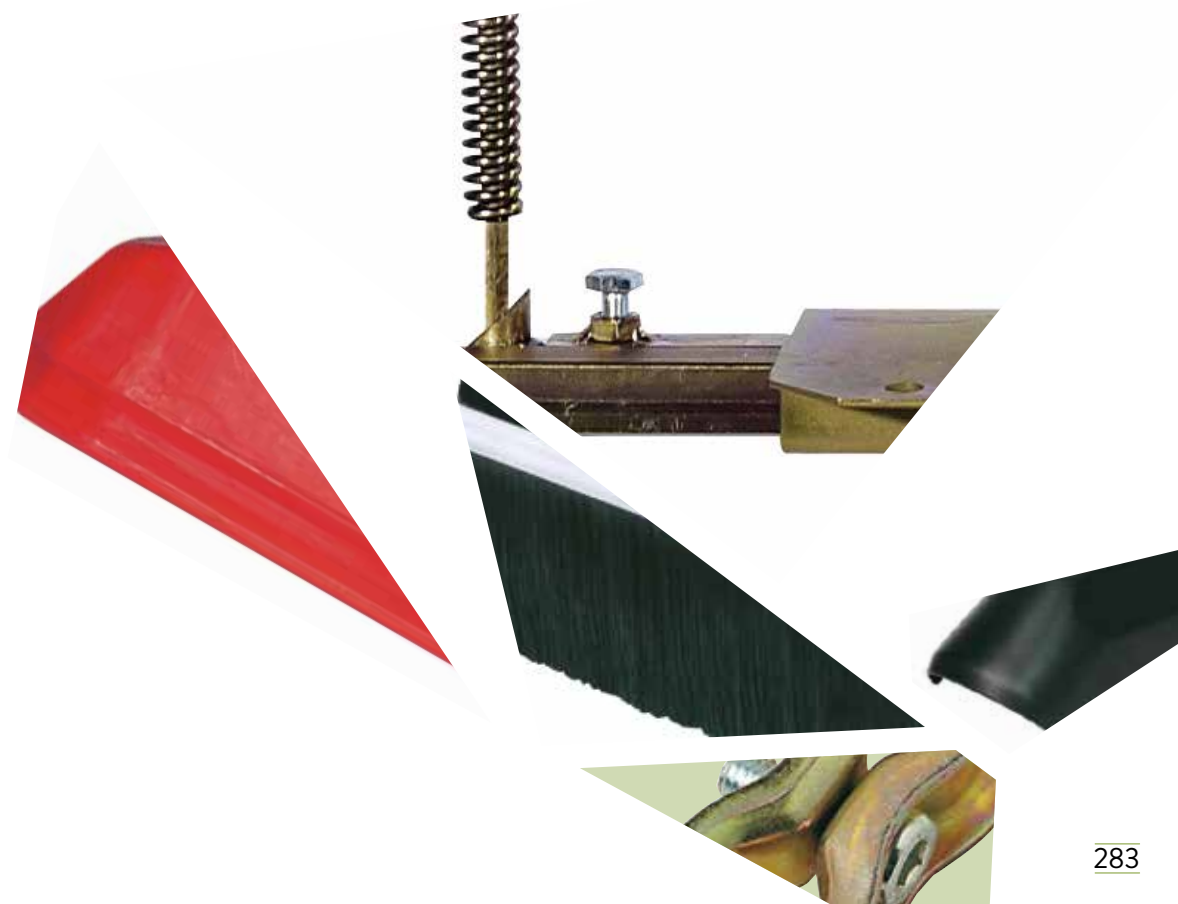

Il nuovo sistema ad innesto rapido permette di assemblare una barra da diserbo senza filettature sul tubo.

Riduce fortemente i tempi di montaggio ed offre molti vantaggi:

- Non necessita di filetti per il fissaggio;
- Disponibile per tubi da 1/2";
- Corpo in polipropilene con fibra vetro;
- O'Ring interni in EPDM.

The new quick coupling system allows assembling a spraying boom without threads on the tube.

Reduced installation time and many other advantages:

- No need for fixing threads;
- Available for 1/2" tubes;
- Polypropylene body with fiberglass;
- Interior EPDM O'Rings.

Le nouveau système d'attache rapide permet d'assembler une rampe de pulvérisation sans filetage sur le tube.

Ce système réduit considérablement le temps d'assemblage et offre de nombreux avantages:

- Aucune nécessité de filets de fixation;
- Disponible pour tubes de 1/2";
- Corps en polypropylène avec fibre de verre;
- O'Ring EPDM intérieurs.



Raccordo ingresso a "T"
Entrance tee
Raccord en "T" d'entrée

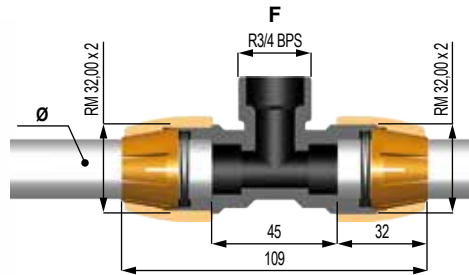

NEW

Part No.	Ø	F	Pack
8294036	1/2"	R 3/4 BPS	10
8294044	3/4"	R 3/4 BPS	10

Terminale chiuso per tubi
Closed hose terminal
Terminal fermé pour tuyaux

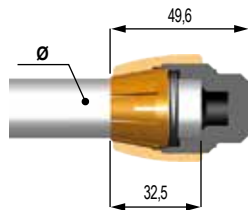

Part No.	Ø	Pack
8294037	1/2"	10

Terminale G 1/2 per tubi
G1/2 hose terminal
Terminal G 1/2 pour tuyaux

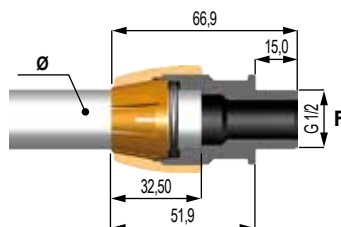

NEW

Part No.	D	F	Pack
8294038	1/2"	G 1/2	10
8294046	3/4"	G 1/2	10

Terminale ATRAP per tubi
Quick coupling hose terminal
Terminal attache-rapide pour tuyaux

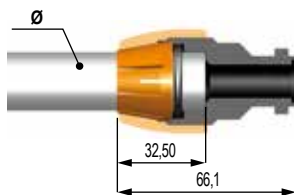

Part No.	Ø	Pack
8294039	1/2"	10

Terminale ATRAP C A/G per tubi
Quick coupling hose terminal with check-valve
Terminal attache-rapide avec anti-goutte pour tuyaux

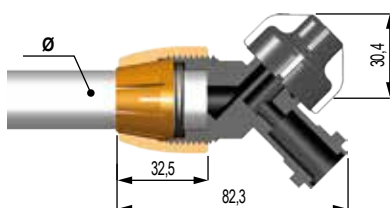

Part No.	Ø	Pack
8294040	1/2"	10

Terminale 90° G 3/4
G 3/4 90° hose terminal
Terminal à 90° G 3/4

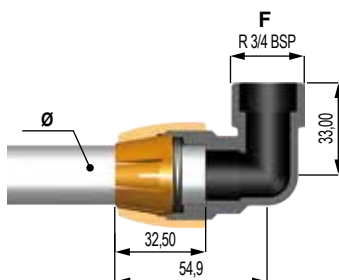

Part No.	Ø	F	Pack
8294041	1/2"	R 3/4 BPS	10

Terminale portagomma 90°
90° hoesetail terminal
Terminal à 90° avec raccord d'entrée

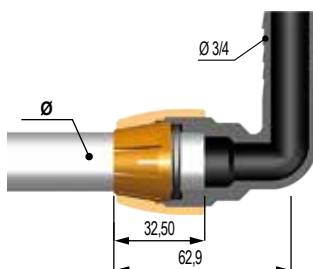

Part No.	Ø	Pack
8294042	1/2"	10

Terminale portagomma
Hoesetail terminal
Terminal avec rac-cord d'entrée

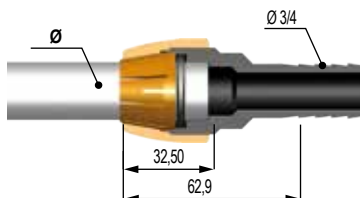

NEW

Part No.	Ø	Pack
8294043	1/2"	10
8294045	3/4"	10

Morsetto supporto barra da diserbo completo di vite e dado *Boom clamps with screw and nut*

Etrier support rampe désherbage. Vis et écrou fournis.

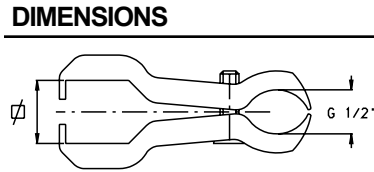

Part No.	Ø	Ø cm	Material	Pack
8294000		25	Steel	
8294001	1/2"	30	Steel	20
8294010		20	Steel	

Aste inox AISI 304 Ø 1/2" foratura 50 cm per barre da diserbo.

AISI 304 stainless steel rods, Ø 1/2" drilled at 50 cm (20 inches) for spray booms.

Tige en acier inoxydable AISI 304 Ø 1/2" trou 50 cm, pour rampes de désherbage.

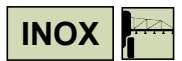

DIMENSIONS

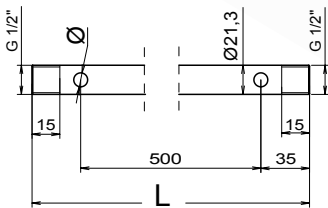

Part No.	L mm	Number of holes	Ø mm	Pack
8292103	370	1		
8292000	570	2		
8292001	1070	3		
8292002	1570	4	7	10
8292003	2070	5		
8292007	2570	6		
8292104	3070	7		
8292105	3570	8		
8292017	1070	3		
8292018	2070	5		
8292019	2570	6		
8292013	1570	4	10	10
8292169	4070	9		
8292184	3070	7		
8292278	3570	8		

Aste inox AISI 304 Ø 1/2", per barre da irrorazione.

AISI 304 stainless steel rods, Ø 1/2" for spraying booms.

Tige en acier inoxydable AISI 304 Ø 1/2", pour rampes de pulvérisation.



DIMENSIONS

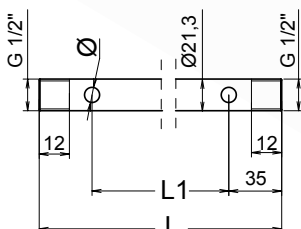

Part No.	L mm	Number of holes	L1 mm	Ø mm	Pack
8292023	800	3	360		
8292022	1000	4	310		
8292024	1000	5	230		
8292025	1200	5	280	7	10
8292026	1400	5	330		
8292027	1600	5	380		

Aste PVC Ø 1/2" foratura 50 cm per barre da diserbo.

PVC rods, Ø 1/2" drilled at 50 cm (20 inches) for spray booms.

Tige en PVC Ø 1/2" trou 50 cm, pour rampes de désherbage.

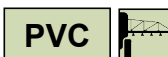

Part No.	L mm	Number of holes	L1 mm	Ø mm	Pack
8292324	570	2			
8292325	1070	3	500	7	10
8292326	1570	4			
8292327	2070	5			

DIMENSIONS

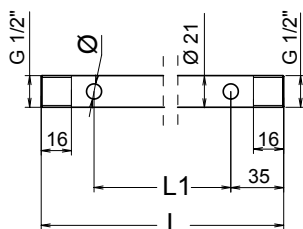

Aste curve inox AISI 304 Ø 20x1mm per gruppi ventola.
Si realizzano versioni su disegno per ogni tipo di ventola.

AISI 304 stainless steel curved rods 20x1mm for ventilating fan units.
Customized production available on request.

Tiges en acier inox AISI 304 de 20x1mm pour groupes ventilation atomiseur.
Autres versions disponible sur demande.



Part No.	ØV mm	R1 mm	Number of holes	Ø mm	Pack
8290011	600	345	6		
8290012	700	395	7	7	10
8290013	800	445	7		
8290014	900	495	7		
8290015	1000	545	7		

DIMENSIONS

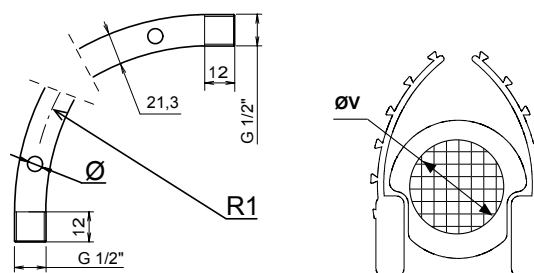

LED

Luce a doppio LED per illuminazione portageggi su barre da diserbo.
Fornita in matasse da 100 pz

LED

Dual LED Light for lighting sections.
Supplied in rolls of 100 pcs/each

LED

Lumière à double led pour illumination pote-buses sur rampe de pulvérisation
Livrabale en bobine de 100 pièces

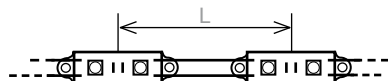

Part No.	L cm	Pack
L00500000	50	100

Reti di protezione zincate per atomizzatori

Zinc-plated protective grid for orchard sprayers

Grille de protection zinguée pour atomiseur

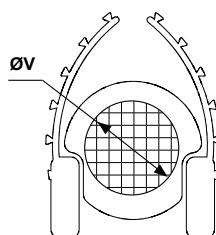
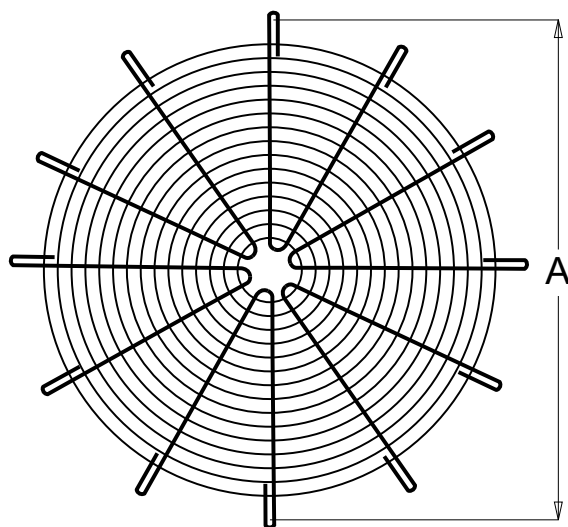

Part No.	A mm	Ø V mm	Number of hooks	Pack
8196001	780	705	12	
8196004	880	805	12	
8196007	980	905	12	
8196010	780	705	6	1
8196013	880	805	6	
8196016	980	905	6	
8196019	584	500	6	
8196022	680	600	6	

Campo di impiego / Use / Utilisation



Barre interfilari meccaniche

- snodo orientabile;
- lunghezza regolabile.

Mechanical Spraying booms

- Swivel joint;
- Adjustable length.

Rampes mécaniques

- Raccord orientable;
- Longueur réglable.



Part No.	◀ Width MIN ▶	◀ Width MAX ▶	using cover type	Pack
	cm	cm		
8292251	140	180	LONG	1
	115	165	SHORT	
	95	145	MINI	

OPTIONALS



Pag. 290 Pag. 290

Barre interfilari meccaniche scoperte

- snodo orientabile
- lunghezza regolabile

Exposed mechanical Spraying booms

- Swivel joint.
- Adjustable length.

Rampes mécaniques découvertes

- Raccord orientable.
- Longueur réglable.

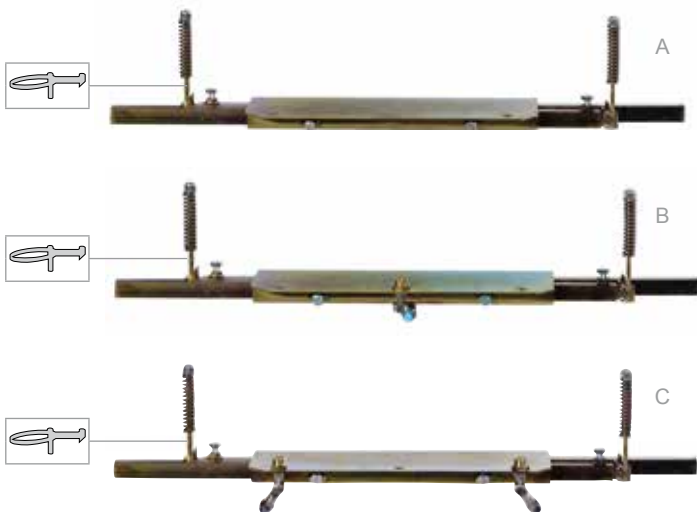

Part No.	Nozzles	◀ Width MIN ▶	◀ Width MAX ▶	Pack
		cm	cm	
A 8292257	/	120	250	1
B 8292258	1	120	250	1
C 8292259	1 + 1	120	250	1

OPTIONALS



Pag. 290

Protezione per barre interfilari.

Shield for interline booms.

Cache-rampe entre rangs.

Fino ad esaurimento
Selling out
Jusqu'à épuisement

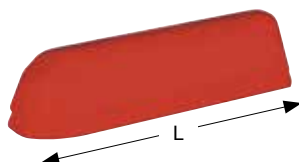

Part No.	Type	L cm	W cm	H cm	Pack
C01000000	LONG	60	18,5	12,5	10

Part No.	Type	L cm	Pack
C01000001	LONG	65	1
C01000002	SHORT	48	1
C01000003	MINI	25	1



SHIELD FOR SPRAYING BOOMS

Protezione per barre interfilari
Ugelli e struttura metallica inclusi.

Shield for interline booms
Including nozzles and metal structure.

Cache-rampe entre rangs
Avec buses et la structure métallique.



A

← L →



B

← L →



C

← L →

	Part No.	Type	L cm	Nozzles	Pack
A	8292272	LONG	65	2 x	2
B	8292273	SHORT	48	2 x	2
C	8292274	MINI	25	1 x	2

Assembly

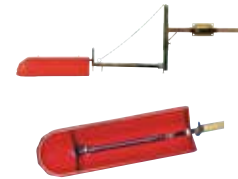

DRIFT FOR SPRAYING BOOMS

Protezione antideriva

Drift Protection

Protection anti-dérive



A

← L →



B

← L →



C

← L →

	Part No.	Type	L cm	Pack
A	P00600010	LONG	65	2
B	P00600011	SHORT	48	2
C	P00600012	MINI	25	2

Assembly



END FOR SPRAYING BOOMS

Terminale per barre interfilari
Ugelli inclusi.

Boom end nozzle protectors
Including nozzles.

Porte buse escamotable pour rampe entre rangs
Avec buses.



A



B

	Part No.	Swivel nozzles	Pack
A	8292275	1 x	2
B	8292276	2 x	2

Assembly





w w w . g e o l i n e . i t







LEGENDA

Campo di impiego / Use / Utilisation

- | | | | | | |
|--|---|---|--|---|--|
|  | Per macchine a basso volume
<i>For low-volume spraying machines</i>
<i>Pour machines basse volum</i> |  | Per atomizzatori
<i>For orchard sprayers</i>
<i>Pour atomiseurs</i> |  | Per macchine da diserbo
<i>For crop sprayers</i>
<i>Pour pulvérisateurs</i> |
|--|---|---|--|---|--|

Caratteristiche / Features / Caractéristique

- | | | | | | |
|--|---|---|--|---|---|
|  | Portata della pompa
<i>Pump flow rate</i>
<i>Débit de la pompe</i> |  | Portata
<i>Flow rate</i>
<i>Débit</i> |  | Pressione d'esercizio
<i>Operating pressure</i>
<i>Pression de service</i> |
|  | Temperatura max
<i>Max temperature</i>
<i>Temperature maxi</i> |  | Peso
<i>Weight</i>
<i>Poids</i> | | |

FEATURES

- | | |
|---|---|
|  | Prodotti non per uso alimentare
<i>Products not for food use</i>
<i>Produits non pour un usage alimentaire</i> |
|  | Temperatura massima
<i>Max temperature</i>
<i>Temperature maxi</i> |

Accessori opzionali Optional Accessoires optionals

- | | |
|---|---|
|  | Ugelli
<i>Nozzles</i>
<i>Buses</i> |
|---|---|

ACCESSORI PER IRRORAZIONE 7

SPRAYER ACCESSORIES / ACCESSOIRES DE PULVÉRISATION

Accessori per irrorazione

Gli accessori per irrorazione GEOLINE sono realizzati nei migliori materiali plastici, mentre i particolari metallici sono in acciaio inox AISI 304 o in ottone per garantire la massima affidabilità e durata.

Sprayer accessories

GEOLINE spraying accessories are made of the best quality plastic materials while the internal metal components are in stainless steel AISI 304 or brass to ensure the utmost reliability and long life.

Accessoires de pulvérisation

Les accessoires de pulvérisation GEOLINE sont en matériaux plastiques les meilleurs, tandis que les parties métalliques sont en acier inox AISI 304 ou bien en laiton pour garantir une fiabilité et une durée optimales.



AL 55



Pistola con lancia a getto regolabile

Gun lances with variable spray

Pistolet avec lances réglable



Part No.	Rated Pressure bar	Permissible Pressure bar	Rated Flow l/min	IN	OUTLET	L mm	kg	Pack
4022409000	220	250	45	G 3/8 F	M15x1 F	749	1,6	5

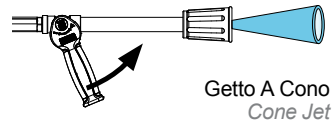
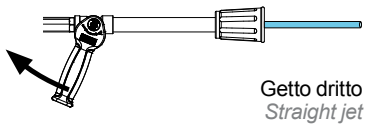

Ordinare ugello separatamente
 Nozzle to be ordered separately
 Commander buse séparément

 Pag. 297

LCX 2015



Lancia irrorazione

- costruita in ottone con tubo in acciaio inox.
- ugello standard in ceramica Ø2,3 mm.
- lunghezza totale 600 mm.
- adatta per trattamenti antiparassitari.

Spray gun

- made of brass with stainless steel tube.
- standard ceramic nozzle Ø2,3 mm.
- total length 600 mm.
- suitable for antiparasite treatments.

Lance

- fabriquée en laiton avec tuyau en acier inox.
- buse standard en céramique Ø2,3 mm.
- longueur totale 600 mm.
- appropriées pour des traitements antiparasitaires.



Part No.	bar		kg	Pack
8282017	50	G 1/2 M	1,6	5

SPARE PARTS

Description	
	Nozzle Pag. 297

LXC 2002



Lancia irrorazione

- costruita in ottone con tubo in acciaio inox.
- ugello standard in ceramica Ø2,3 mm.
- lunghezza totale 600 mm.

Spray gun

- made of brass with stainless steel tube.
- standard ceramic nozzle Ø2,3 mm.
- total length 600 mm.

Lance

- fabriquée en laiton avec tuyau en acier inox.
- buse standard en céramique Ø2,3 mm.
- longueur totale 600 mm.



Part No.	bar		kg	Pack
8282012	50	G 1/2 M	1,6	5

OPTIONALS

Part No.	Description	F	Pack
8288007	Raccordo girevole 50 bar. Swivel connection 50 bar. Raccord tournant 50 bar.	G 1/2 M - G 1/2 F	1



SPARE PARTS

Description	
	Nozzle Pag. 297

SLAM 907



Pistola irrorazione regolabile

- Impugnatura ergonomica in nylon® rinforzato con fibra di vetro.
- Bilanciamento dello sforzo di azionamento.
- Completa di diffusore per miscelazione d'aria regolabile. Consente una perfetta micronebulizzazione del liquido irrorato ed un basso impatto sulla coltura trattata.
- Blocco di chiusura di facile azionamento e conforme ad UNI EN 907.
- Parti interne in acciaio inox, ottone e ceramica.
- Canna in acciaio inox.
- Ugello standard in ceramica Ø1,5 mm.

Adjustable spraying gun

- Ergonomic nylon® handgrip, reinforced with fibreglass.
- Balancing trigger.
- Equipped with adjustable air mixing diffuser. Perfect micro spraying of the liquid and low impact on the cultivation treated.
- Handy spray lock lever and compliant with UNI EN 907.
- Inner parts made of brass, stainless steel and ceramic.
- Pipe in stainless steel.
- Equipped with standard ceramic spray tip Ø1,5 mm.

Pistolet de pulvérisation réglable

- Poignée en nylon® ergonomique à renfort en fibre de verre
- Équilibrage de l'effort d'actionnement.
- Fourni avec diffuseur pour le mélange d'air réglable ; permet d'assurer une micro-pulvérisation parfaite du liquide distribué et garantit un faible impact sur la culture traitée.
- Bloc de fermeture conforme à la norme UNI EN 907.
- Parties internes en laiton, acier inox et céramique.
- Tube en acier inox.
- Buse céramique standard Ø1,5 mm.

- Possibilità di regolare l'ampiezza del cono di spruzzo. Reversibile anche per mancini.
- Protezione della mano inclusa.

- Adjustable hollow cone spray pattern. Reversible also for left-handed users.
- Hand guard included.

- Jet conique réglable, réversible pour gauchers.
- Avec protection pour la main.



Part No.	bar	mm	kg	Pack
8284018		1,0		
8284017		1,2		
8284011	50	1,5	G 1/2 M swivel	5
8284019		2,0		
8284020		2,5		

HIGHLIGHTS



SPARE PARTS

Description
 Nozzle Pag. 297



NOZZLES

Ugelli di ricambio per lance

Spare nozzles for spray guns

Buses de rechange pour lances

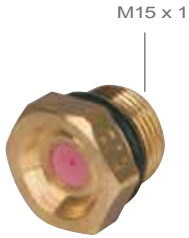

- a cono in ceramica
 - ceramic hollow cone tip
 - en céramique, jet conique

Part No.	Ø mm	Icon	I/1'	15 bar		25 bar		35 bar		40 bar		45 bar		50 bar		Pack
				CONE	STRAIGHT	CONE	STRAIGHT	CONE	STRAIGHT	CONE	STRAIGHT	CONE	STRAIGHT	CONE	STRAIGHT	
8278000	1,0	☞	I/1'	2,45	2,5	3,0	3,1	3,4	3,5	3,55	3,65	3,75	3,85	4,0	4,1	
8278001	1,2	☞	I/1'	3,6	6,8	4,25	4,6	4,7	5,4	5,2	5,9	5,35	6,1	5,6	6,3	
8278002	1,5	☞	I/1'	4,6	5,1	5,7	6,5	6,6	7,4	6,9	7,8	7,3	8,2	7,7	8,6	
8278003	1,8	☞	I/1'	5,9	7,3	7,2	9,3	8,5	10,8	9,2	11,7	9,7	12,2	10,5	12,7	
8278004	2,0	☞	I/1'	6,9	8,8	8,1	11,7	10,2	13,4	10,9	14,3	11,7	15,2	12,5	15,8	
8278005	2,3	☞	I/1'	8,1	10,8	10,2	14,1	12,9	16,8	13,7	17,9	14,3	18,8	14,9	19,7	25
8278006	2,5	☞	I/1'	9,2	13,0	11,4	16,4	14,0	19,1	14,5	21,1	15,4	22,2	16,4	23,0	
8278007	3,0	☞	I/1'	11,5	18,4	14,4	24,1	18,0	28,2	18,8	30,1	19,6	31,5	20,9	33,0	
8278015	3,5	☞	I/1'	14,1	21,4	18,2	27,6	21,6	32,6	23,1	34,9	24,5	37,0	25,8	39,0	
8278014	3,8	☞	I/1'	13,9	22,5	17,9	29,1	21,2	34,4	22,6	36,8	24,0	39,0	25,3	41,1	

SUITABLE FOR



Tabella selezione ugello
 Chart nozzle selection
 Table de sélection de buse

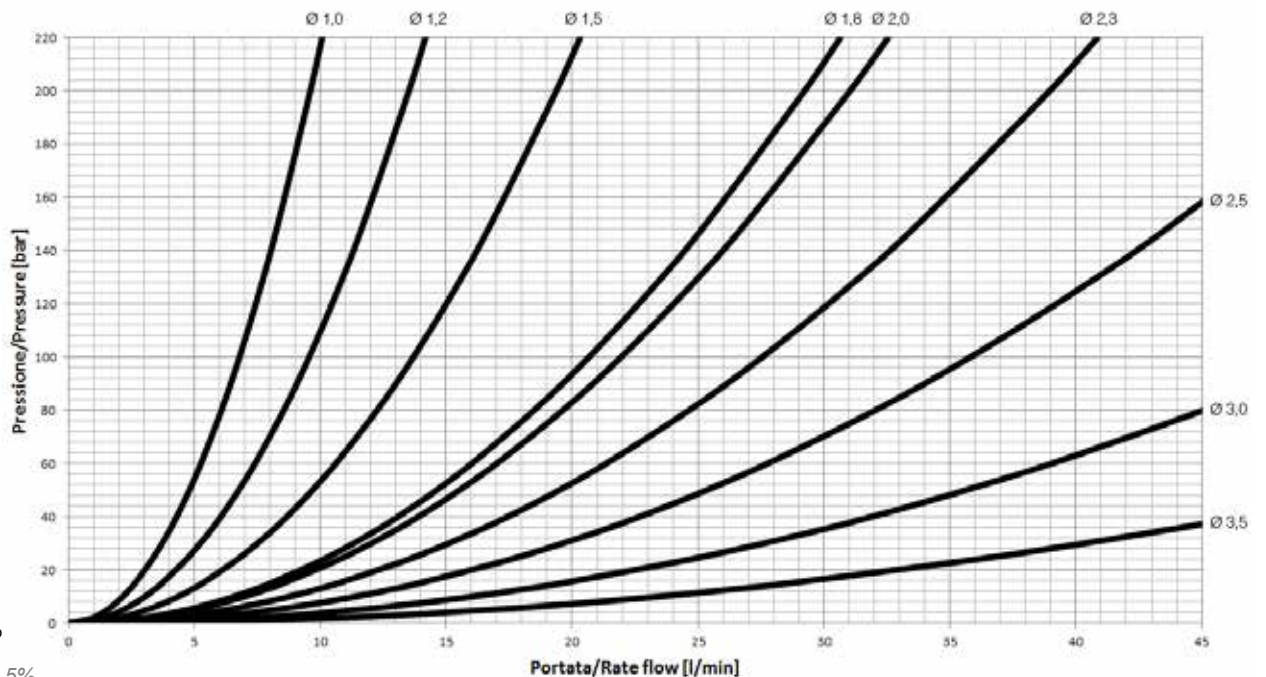

Tolleranza portata ± 5%
 Flow tolerance ± 5%
 Tolérance de débit ± 5%

SG 40-600



Pistola irrorazione regolabile

- Possibilità di regolare l'angolo di spruzzo.
- Possibilità di inserire il fermo posizione con tenuta istantanea antigoccia.
- Realizzata con materiali plastici ad alta resistenza.
- Ugello standard in ceramica.

Adjustable spraying gun

- Adjustable spray pattern.
- Stop lever with instant drip sealing.
- Made of high resistance plastic materials.
- Equipped with standard ceramic spray tip.

Pistolet de pulvérisation réglable

- Jet réglable à angle variable
- Levier d'arrêt à étanchéité antigoutte (su e di arrest ci vuole l'acc circonflusso)
- Réalisée avec matériaux plastiques à haute résistance
- Buse céramique standard.

Lunghezza 600 mm

Length 600 mm

Longueur 600 mm



Part No.	bar	L mm	mm	mm	kg	Pack
8282013	40	600	Ø 1,5	Ø 10	1,4	5

SG 40-300



Lunghezza 300 mm

Length 300 mm

Longueur 300 mm

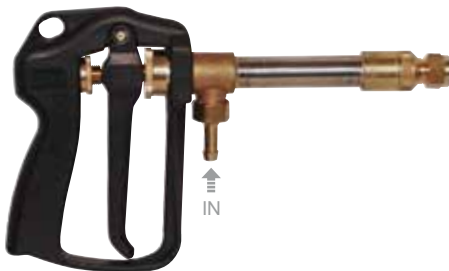

Part No.	bar	L mm	mm	mm	kg	Pack
8282014	40	300	Ø 1,5	Ø 10	1,0	5

SPARE PARTS

Part No.	Description	Hole Ø mm	Pack
8259167		0,8	
8259168	Piastrina in ceramica Ø 15 mm	1,0	
8259169	Ceramic disc Ø 15 mm	1,2	
8259170	Pastille en céramique Ø 15 mm	1,5	100
8259171		1,8	
8259172		2,0	

ML 310



Idropistola con tubo inox e ugello

- Scocche in plastica antiurto nere;
- Sede in plastica, sfera e tubo in acciaio inox;
- Corpo pistola in ottone stampato;
- Portagomma in ottone;
- Ugello in ottone registrabile;
- Targhette colorate.

Spray-gun pipe stainless steel and nozzle

- Anti-shock black color plastic shell;
- Plastic seat, stainless steel ball and pipe;
- Gun body in forged brass;
- Brass hose;
- Adjustable brass nozzle;
- Colored side plates.

Tuyau de pistolet pulvérisateur en acier inoxydable et buse

- Coque en plastique anti-choc noire ;
- Siège en plastique, sphère et tuyau en acier inoxydable ;
- Corps du pistolet en laiton forgé ;
- Tuyau en laiton ;
- Buse réglable en laiton ;
- Plaquettes colorées.



Part No.	bar	l/1'	°C	mm	kg	Pack
4018000130	24	25	60	Ø 10	0,533	10

SPARE PARTS

Part No.	Description	Pack
U00000134	Conejet nozzle M12-19 F	1



Part No.	bar	l/1'	°C	mm	kg	Pack
4018000157	24	25	60	G 1/2 M	0,549	10

SPARE PARTS

Part No.	Description	Pack
U00000134	Conejet nozzle M12-19 F	1



OPTIONALS



Jolly 25



Lancia serie Jolly

Elevata ergonomia e leggerezza.
 Materiali plastici PP H 30%FVo.
 Materiale pistone e sfera: AISI 316.
 Materiali o-ring: Viton® o EPDM.
 Materiale sede: POM.
 Colore tappo identificativo o-ring.
 Gancio per appendere pistola.
 Corpo pistola liscio per evitare depositi di sporco,
 idoneo nell'industria alimentare.
 Gancio per mantenimento pistola aperta.
 Filtro ingresso e filtro ugello optional.
 Ugelli inox o POM a scelta.

Spray guns Jolly series

Great ergonomics and lightness.
 Plastic material: PP H 30%GF.
 Pin and ball material: AISI 316.
 O-ring material: Viton® or EPDM.
 Seat Material: POM.
 Plug color to identify o-ring.
 Hook to hung the gun.
 Flat body gun design to avoid dirty deposit, ideal
 for food industry.
 Lock system to keep opened the gun.
 Inlet/Outlet filters available as optional.
 Choice of S.Steel or POM nozzles.

Lances série Jolly

Poignée ergonomique et légère.
 Fabriqué en PP H 30% FV.
 Piston et sphère en acier inox AISI 316.
 O-ring en Viton® ou EPDM.
 Siège en POM.
 Bouchon coloré pour O-ring.
 Crochet de suspension.
 Poignée et corps lisses – Aucun dépôt de saleté –
 Idéal pour l'industrie alimentaire.
 Levier de blocage en ouverture.
 Filtre entré et filtre de buse en option.
 Buses en POM ou acier inox sur demande.

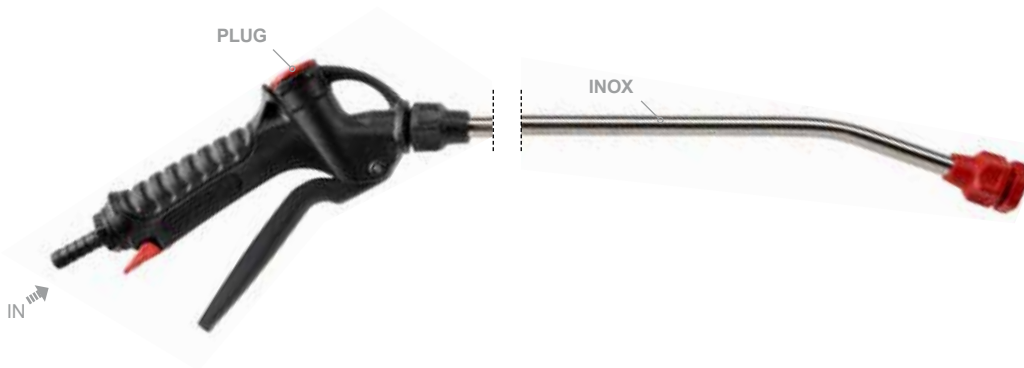

Part No.	bar	l/1'	°C	L mm	Pipe Material	mm	O-Ring	Plug Colour	kg	Pack
4020009025	15	30	50	750	Stainless Steel	Ø10	Viton®	■	0,38	10

Getto a ventaglio
 Fan jet

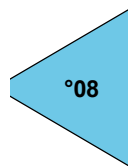

Lancia completa di: portagomma, filtro, ugello.
 Hose-tail, filter and nozzle included.
 Avec: raccord d'entrée, filtre et buse.

Jolly 25



Lancia serie Jolly

Elevata ergonomia e leggerezza.
Materiali plastici PP H 30%FV.
Materiale pistone e sfera: AISI 316.
Materiali o-ring: Viton® o EPDM.
Materiale sede: POM.
Colore tappo identificativo o-ring.
Gancio per appendere pistola.
Corpo pistola liscio per evitare depositi di sporco, idoneo nell'industria alimentare.
Gancio per mantenimento pistola aperta.
Filtro ingresso e filtro ugello optional.
Ugelli inox o POM a scelta.

Spray guns Jolly series

Great ergonomics and lightness.
Plastic material: PP H 30%GF.
Pin and ball material: AISI 316.
O-ring material: Viton® or EPDM.
Seat Material: POM.
Plug color to identify o-ring.
Hook to hung the gun.
Flat body gun design to avoid dirty deposit, ideal for food industry.
Lock system to keep opened the gun.
Inlet/Outlet filters available as optional.
Choice of S.Steel or POM nozzles.

Lances série Jolly

Poignée ergonomique et légère.
Fabriqué en PP H 30% FV.
Piston et sphère en acier inox AISI 316.
O-ring en Viton® ou EPDM.
Siège en POM.
Bouchon coloré pour O-ring.
Crochet de suspension.
Poignée et corps lisses – Aucun dépôt de saleté – Idéal pour l'industrie alimentaire.
Levier de blocage en ouverture.
Filtre entré et filtre de buse en option.
Buses en POM ou acier inox sur demande.

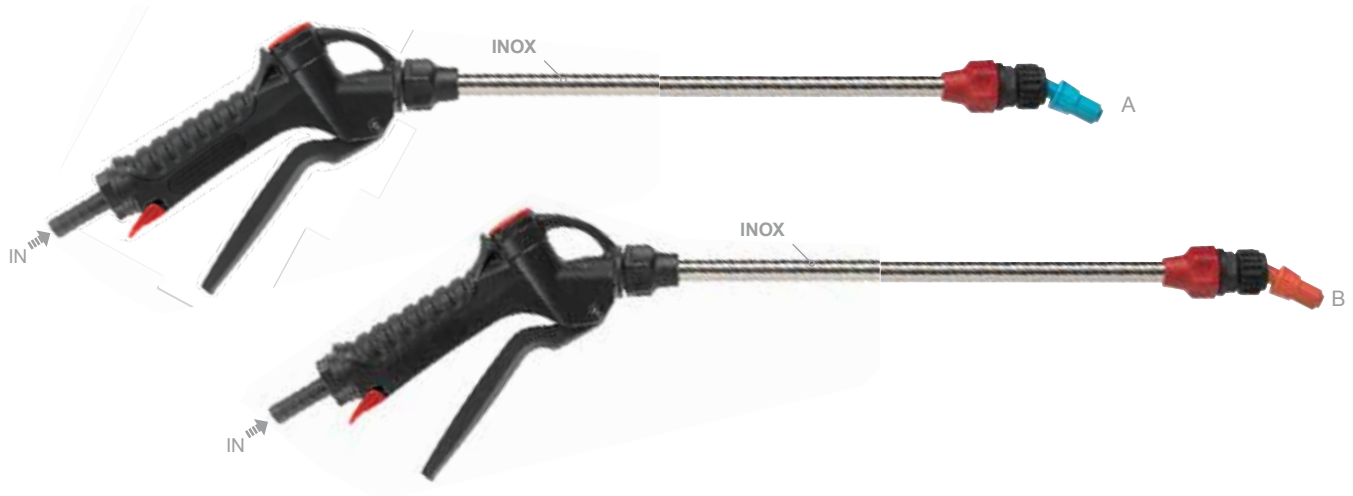

	Part No.	bar	l/1'	°C	mm	L mm	Plug Colour	Pipe Material	O-Ring	Nozzle	kg	Pack
A	4020009026	15	30	50	Ø10	627	■	Stainless Steel	Viton®	Blue	0,36	10
B	4020009048				Ø10	627	■	Stainless Steel	Viton®	Orange	0,36	10

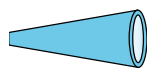

Getto a cono
Cone jet



Getto dritto
Straight jet

Lancia completa di: portagomma, filtro, ugello.
Hose-tail, filter and nozzle included.
Avec: raccord d'entrée, filtre et buse.

Nozzle	Jet	2 bar		3 bar		4 bar		7 bar	
		CONE	STRAIGHT	CONE	STRAIGHT	CONE	STRAIGHT	CONE	STRAIGHT
Blue	1/1'	1,7	4,4	2	5,3	2,3	6,1	3,1	8,1
	USG/1'	0,45	1,17	0,54	1,39	0,62	1,59	0,81	2,11
Orange	1/1'	0,91	3,1	1,1	3,5	1,3	4,2	1,6	5,3
	USG/1'	0,24	0,82	0,29	0,92	0,34	1,11	0,42	1,40

SPARE PARTS

Part No.	Description	Nozzle color	Material	Connection	Pack
U00000115	Ugello regolabile per pistola Jolly 25 Adjustable nozzle for Jolly 25 gun	Blue	PP	11/16" - 16	
U00000118	Buse réglable pour pistolets Jolly 25	Orange	PP	11/16" - 16	

Jolly 25



Part No.	bar	l/1'	°C	O-Ring	Plug Colour	kg	Pack
4010007000	15	30	50	G 1/2 F EPDM	Blue	0,20	5
4010007001	15	30	50	G 1/2 F Viton®	Red	0,25	5



Part No.	bar	l/1'	°C	mm	O-Ring	Plug Colour	kg	Pack
4010007005	15	30	50	Ø10	EPDM	Blue	0,22	5
4010007006	15	30	50	Ø10	Viton®	Red	0,22	5

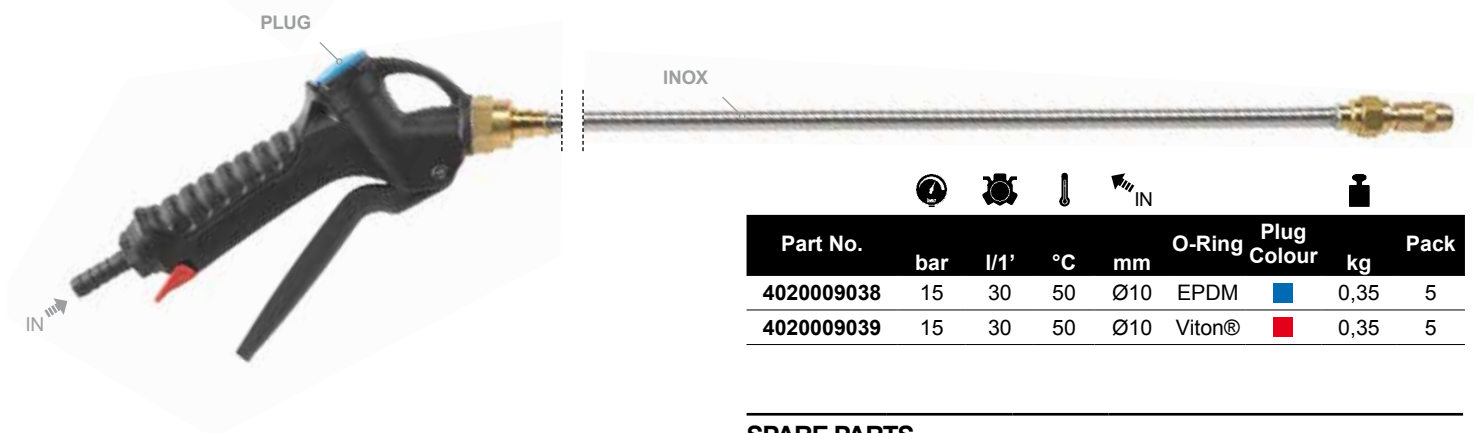

Part No.	bar	l/1'	°C	mm	O-Ring	Plug Colour	kg	Pack
4020009038	15	30	50	Ø10	EPDM	Blue	0,35	5
4020009039	15	30	50	Ø10	Viton®	Red	0,35	5

SPARE PARTS

Part No.	Description	Pack
U00000134	Conejet nozzle M12-19 F	1



Part No.	L mm	Material	Pack
8288014	500	Inox	
8288015	700	Inox	10
8288016	1000	Inox	

Prolunga per lancia
 Spray gun extension
 Rallonge pour lance



Lancia con impugnatura a leva
 Handgrip spray gun
 Lance à levier

Part No.	Pack
8280002	10



Lancia con filtro e rubinetto a sfera
 Spray gun with filter and ball cock
 Lance avec filtre et robinet à bille

Part No.	Pack
8280001	10



Cartuccia ricambio per lance cod.:
 8280001 - 8280002 - 8280003

Part No.	Pack
C00100045	5

Spare cartridge for spray guns P/N:
 8280001-8280002-8280003

Cartouche de rechange pour lances réf.:
 8280001-8280002-8280003

Curva fissa M-F
 Elbow M-F
 Raccord coudé M-F

Part No.	Pack
8288004	10

Ugello registrabile Ø 1,5 mm
 Adjustable spray nozzle Ø 1,5 mm
 Buse réglable Ø 1,5 mm

Part No.	Pack
8286000	10



Ugello registrabile economico
 Adjustable nozzle
 Buse réglable, modèle économique

Part No.	Pack
8286003	10



Campana per diserbo localizzato
 Shield for localized weed-removal
 Cloche pour désherbage localisé

Part No.	F	Pack
8292004	12x19	3
8292010	1/4"	3



Part No.	L mm	Material	Pack
8288002	500	Brass	10
8288003	750	Brass	

Prolunga per lancia
 Spray gun extension
 Rallonge pour lance

Fino ad esaurimento
 Selling out
 Jusqu'à épuisement

Fino ad esaurimento
 Selling out
 Jusqu'à épuisement

Part No.	L mm	Pack
8288009	1000	10

Prolunga per lancia telescopica
 Spray gun telescoping extension
 Rallonge télescopique pour lance

LP12



Pistola bassa pressione con getto a spillo/ a cono regolabile dalla leva e della manopola

- Leggera e semplice da usare
- Struttura interna realizzata in PP rinforzato con fibra vetro
- Giunto girevole in entrata con raccordo in acciaio inox
- Scocche in plastica morbida resistente agli urti e antimacchia
- Scocca sigillata per evitare il ristagno dello sporco
- Stelo e molla in acciaio inox
- Guarnizioni in EPDM
- Può operare a temperature e pressioni differenti per un'ampia gamma di applicazioni

- Low pressure spray gun with pencil/cone water jet adjustable from trigger and rear knob

- Lightweight and easy to use
- Internal structure made in PP reinforced with glass fiber
- Inlet swivel connection with stainless steel fitting
- Soft plastic shells at impact and stain resistant
- Sealed shells to avoid the built up of dirt
- S/S shaft and spring
- EPDM sealing
- Can operate at different temperatures and different pressures for a wide range of applications

Pistolet à basse pression avec jet droit / conique réglable du levier et de la poignée

- Léger et facile à utiliser
- Structure interne en fibre PP renforcé avec fibre de verre
- Rotule d'entrée avec raccord en acier inoxydable
- Boîtiers plastiques souples et résistants aux chocs et aux taches
- Boîtier scellé pour empêcher l'accumulation de saleté
- Tige et ressort en acier inoxydable
- Joints en EPDM
- Fonctionnement à différentes températures et pressions pour une large gamme d'applications

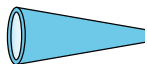

Getto a cono
 Cone jet



Getto dritto
 Straight jet

Part No.	bar	O-Ring	g	Pack
4010008000	12	SWIVEL G 1/2 F EPDM	420	1

DIMENSIONS

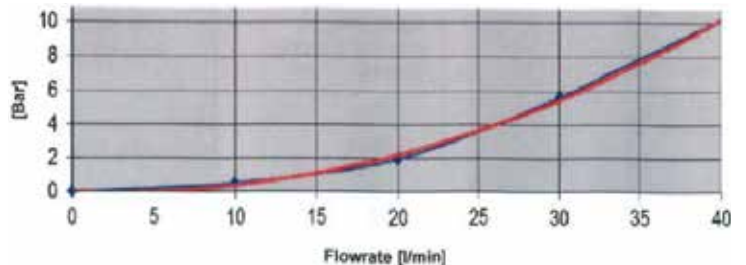
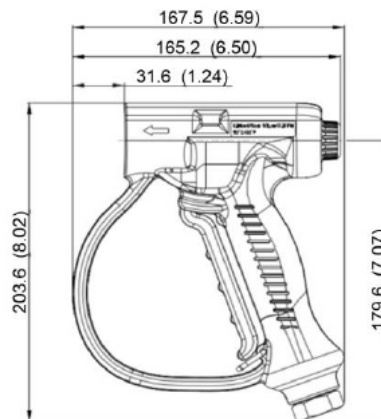

Lancia a leva

- Ugello in ceramica Ø1,5 mm con protezione
- Trigger spray gun
- Ceramic nozzle tip Ø1,5 mm with protection
- Lance à levier
- Buse en ceramique Ø1,5 mm avec support

Part No.	bar	L mm	Pack
8282000	40	300	10
8282001	40	600	10
8282002	40	1000	10

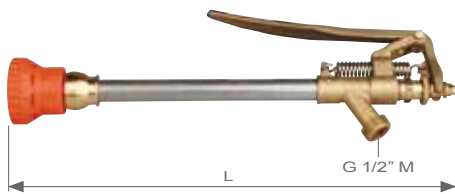

SPARE PARTS

Description		Pag.
	Nozzles - Heads	305

Lancia a manopola

- Ugello in ceramica Ø1,5 mm con protezione
- Handle spray gun
- Ceramic nozzle tip Ø1,5 mm with protection
- Lance à poignée
- Buse en ceramique Ø1,5 mm avec support

Part No.	bar	L mm	Pack
8282003	40	300	10
8282004	40	600	10
8282005	40	1000	10

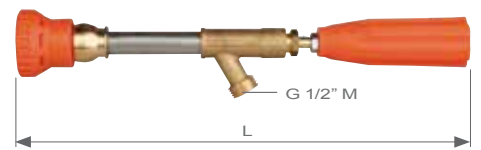



- Kit testina per ugelli in ceramica (senza ugello)
- Head assembly for ceramic nozzles (nozzle not included)
- Kit tête pour buses en ceramique (buse non fournie)

Part No.	Pack
8288008	10



SPARE PARTS





Part No.	Description	Pack
	G00002070 Gasket	50
	G00001120 O-Ring	50

- Kit testina con ugello inox Ø1,5 mm
- Head assembly with inox nozzle Ø1,5 mm
- Kit tête avec buse inox diam. 1,5 mm

Part No.	Pack
8288005	10



OPTIONALS

Part No.	Description	Ø mm	15 bar CONE	(200 psi) STRAIGHT	30 bar CONE	(450 psi) STRAIGHT	50 bar CONE	(700 psi) STRAIGHT	Pack
8259157		1	V1'	1,8	2,3	2,6	3,2	3,4	4,1
			USG/1'	0,44	0,56	0,71	0,87	0,87	1,05
8259158		1,2	V1'	2,4	3,0	3,4	4,2	5,4	5,4
			USG/1'	0,58	0,73	0,93	1,15	1,12	1,38
8259159		1,5	V1'	3,4	4,5	4,8	6,4	6,2	8,3
			USG/1'	0,83	1,1	1,31	1,78	1,59	2,12
8259160		1,8	V1'	3,9	6,9	5,5	9,8	7,1	12,7
			USG/1'	0,95	1,68	1,50	2,68	1,81	3,24
8259161		2	V1'	4,5	8,3	6,3	11,7	8,1	15,1
			USG/1'	1,1	2,0	1,73	3,2	2,1	3,85



Colonne irroranti

Column spraying booms

Colonnes de pulvérisation



Part No.	Nozzles	bar	Pack
8290005	3	50	2
8290006	4	50	

Barra a colonna
 Column spraying boom
 Rampe à colonne



Part No.	Nozzles	Pack
8294007	3	5
8294008	4	

Colonna nuda
 Simple column
 Colonne simple

Portaugello ciclone con diffusore "Turbo"
 Ugello standard a cono Ø1,5 mm.

Nozzle holder with "Turbo" diffuser
 Standard hollow cone nozzle tip Ø1,5 mm.

Porte-buse pour atomiseur avec diffuseur "Turbo"
 Buse à cône standard Ø1,5 mm.



Part No.	F	THROW			Pack
		bar	m	Kg	
8275008	G 3/8 M	50	12	0,85	5

Getto registrabile orientabile

- Materiale: ottone;
- Guarnizioni: Viton®;
- Pressione di lavoro 40 bar;
- Permette di regolare l'angolo di spruzzo per trasformare tutti i portaugelli singoli e doppi in portaugelli con lato regolabile.

Adjustable directional jet

- Material: brass;
- Seals: Viton®;
- Working pressure 40 bar;
- Enables the spray angle to be adjusted to transform all single and double nozzle holders into adjustable nozzle holders.

Jet réglable orientable

- Matériau : laiton;
- Joints : Viton®;
- Pression de travail 40 bars;
- Permet de régler l'angle de pulvérisation pour transformer tous les porte-buses individuels et doubles en porte-buses avec côté réglable.

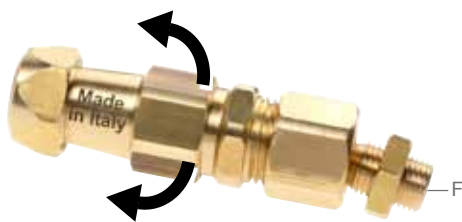

DIMENSIONS

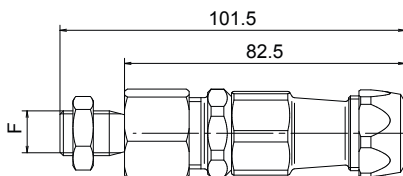

Part No.	F	DISC	Pack
8275021	G 1/4 M (BSP)	1 x Ø 15	10
8275022	G 1/4 M (BSP)	1 x Ø 18	

ASSEMBLY (Part No. 8275021)

ASSEMBLY (Part No. 8275022)

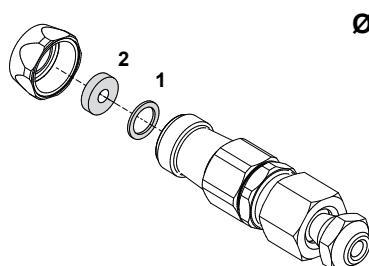

Ø 15 mm

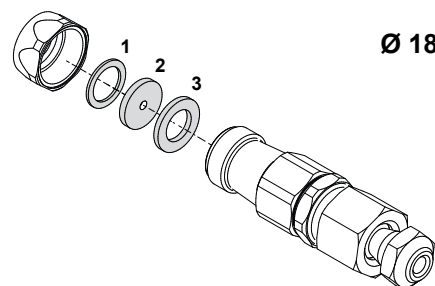

Ø 18 mm



Per completare i portaugelli, ordinare piastrine e guarnizioni
 To complete the nozzle holders, order plates and seals
 Pour compléter les porte-buses, commander pastilles et joints

Ø15 mm (Pag. 313)

Ø18 mm (Pag. 314)



Nebulizzatore leggero registrabile

Adjustable bent sprayer

Nébulisateur léger réglable

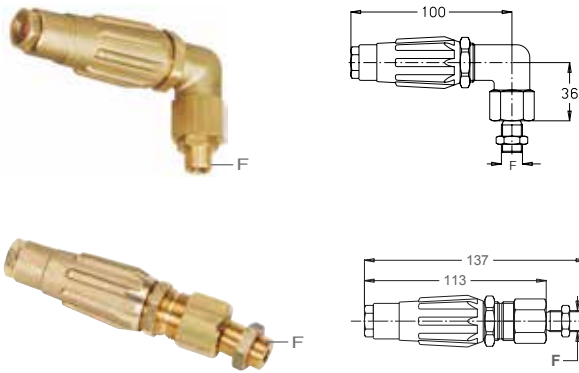

Part No.	F	mm	Nozzle Material	Pack
8275011	G 3/8 M (BSP)	1,5	Ceramic	5
8275012	G 1/4 M (BSP)	1,5		

Part No.	F	mm	Nozzle Material	Pack
8275016	G 1/4 M (BSP)	1,5	Ceramic	5
8275017	G 3/8 M (BSP)	1,5		

Fino ad esaurimento
 Selling out
 Jusqu'à épuisement

Snodo sferico
 Ball joint
 Raccord articulé

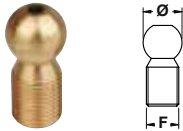

Part No.	Ø mm	F	Pack
8304014	16	G 1/4 M	10
8304017	20	G 3/8 M	

Dado
 Nut
 Ecrou

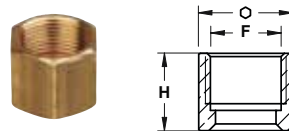

Part No.	H mm	F	Ø	Pack
8304015	16,5	G 1/4 F	19	10
8304018	20	G 3/8 F	27	

Controdado
 Locking nut
 Contre écrou

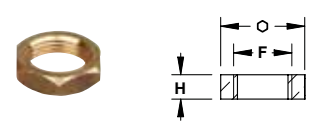

Part No.	H mm	F	Ø	Pack
8304016	5,5	G 1/4 F	19	10
8304019	6,5	G 3/8 F	24	
8304058	8,0	G 3/4 F	32	

Portaugello singolo antigoccia.
 Pressione di esercizio 30 bar.
 Utilizzo consigliato su atomizzatori e nebulizzatori a basso volume.
 Il volantino chiuso interrompe il passaggio.

Nozzle holder with diaphragm check valve
 Operating pressure: 30 bar
 Use: on low volume and orchard sprayers.
 Knob in closed position stops the flow.

Porte-buse avec antigoutte.
 Pression de service 30 bar.
 Utilisation recommandé sur atomiseurs et pulvérisateurs à volume bas.
 Le volant fermée arrête l'écoulement.



Part No.	IN	OUT	Type	Pack
8267007	G 1/4 F	G 1/4 F	STD	10
8267008	G 1/4 M	G 1/4 F	STD	
8267009	G 1/4 F	G 1/4 F	ON/OFF	
8267010	G 1/4 M	G 1/4 F	ON/OFF	

DIMENSIONS

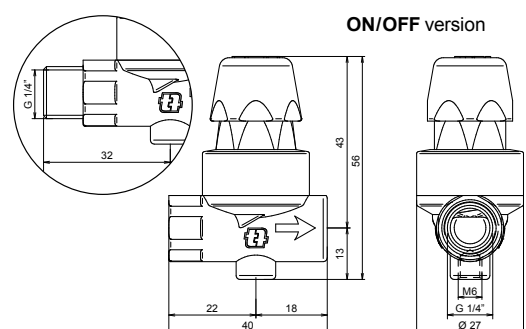
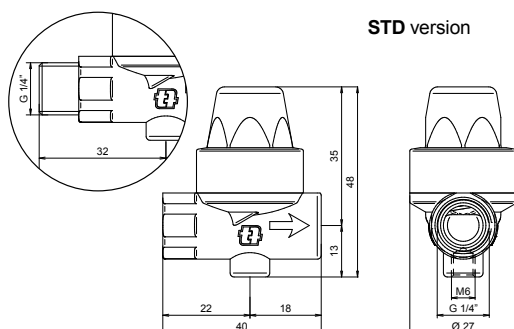

Getto regolabile fisso

- Utilizzo su macchine irroratrici e per trattamenti fito sanitari;
- Getto regolabile compatto e leggero con attacco fisso;
- Materiale: ottone;
- Guarnizioni: Viton®

Fixed adjustable jet

- For use on spraying equipment and for phytosanitary treatments;
- Compact and light adjustable jet with fixed fitting;
- Material: brass;
- Seals: Viton®

Jet réglable fixe

- Utilisation sur pulvérisateurs et pour traitements phytosanitaires;
- Jet réglable compact et léger avec raccord fixe ;
- Matériau : laiton ;
- Joints : Viton®

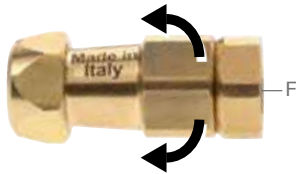

DIMENSIONS

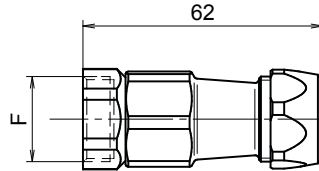

Part No.	F	DISC	Pack
8275019	M22x1,5	1 x Ø 15	10
8275020	M22x1,5	1 x Ø 18	

ASSEMBLY (Part No. 8275019)

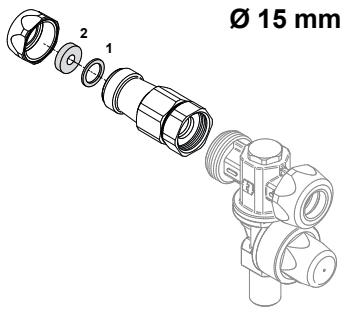

ASSEMBLY (Part No. 8275020)

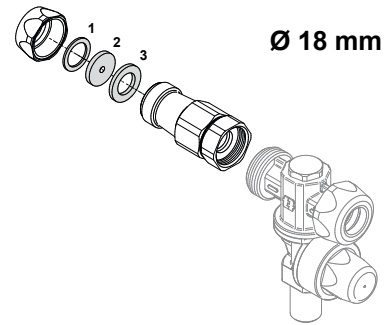

Per completare i portaugelli, ordinare piastrine e guarnizioni
 To complete the nozzle holders, order plates and seals
 Pour compléter les porte-buses, commander pastilles et joints

Ø15 mm (Pag. 313)

Ø18 mm (Pag. 314)



Portaugello atomizzatore doppio con antigoccia e ghiera.

Double nozzle holder with diaphragm check valve and fly nuts.

Porte-buses atomiseur 2 sorties avec antigoutte et écrous.

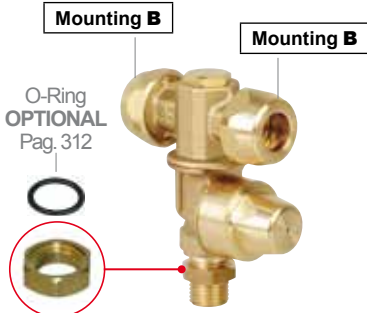

DIMENSIONS

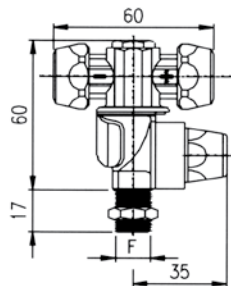

OPTIONALS

Part No.	Page
8275019	308
8275020	308



Part No.	DISC	F	Pack
8268C0002	2 x Ø15	G1/4 M	10



Per completare i portaugelli, ordinare piastrine Ø15 mm (Pag. 313)
 To complete the nozzles holder, please order core Ø15 mm (Pag. 313)
 A commander pour compléter le porte-buses pastilles Ø15 mm (Pag. 313)



Portagello atomizzatore singolo con antigoccia e ghiera

Nozzle holder with diaphragm check valve and fly nuts

Porte-buse atomiseur avec antigoutte à membrane et écrous



DIMENSIONS

O-Ring
 OPTIONAL
 Pag. 312

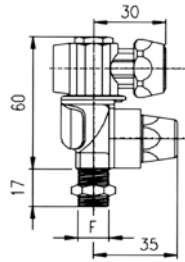
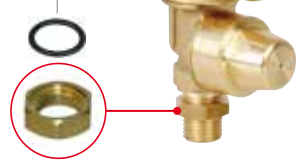

OPTIONALS

Part No. Page

8275019 308

8275020 308



Part No.	DISC	CONE NOZZLE	F	Pack
8267000	1 x Ø18	-	G 1/4 M	
8267001	1 x Ø18	-	G 1/4 F	
8267002	1 x Ø18	-	G 3/8 M	
8267003	-	1 x ATR/MGA	G 1/4 M	10
8267004	-	1 x ATR/MGA	G 1/4 F	
8267005	-	1 x ATR/MGA	G 3/8 M	

Portagello atomizzatore doppio con antigoccia e ghiera

Double nozzle holder with diaphragm check valve and fly nuts

Porte-buses atomiseur 2 sorties avec antigoutte et écrous



DIMENSIONS

O-Ring
 OPTIONAL
 Pag. 312

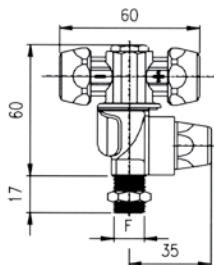
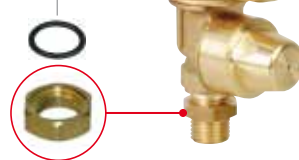

OPTIONALS

Part No. Page

8275019 308

8275020 308



Part No.	DISC	CONE NOZZLE	F	Pack
8268000	2 x Ø18	-	G 1/4 M	
8268001	2 x Ø18	-	G 1/4 F	
8268002	2 x Ø18	-	G 3/8 M	
8268003	1 x Ø18	1 x ATR/MGA	G 1/4 M	10
8268004	1 x Ø18	1 x ATR/MGA	G 1/4 F	
8268005	1 x Ø18	1 x ATR/MGA	G 3/8 M	
8268006	-	2 x ATR/MGA	G 1/4 M	
8268007	-	2 x ATR/MGA	G 1/4 F	
8268008	-	2 x ATR/MGA	G 3/8 M	
8268022	2 x Ø18	-	G 3/8 M - 1/8 F	

Portagello atomizzatore con ghiera

Nozzle holder with fly nuts

Porte-buse atomiseur avec embout



DIMENSIONS

O-Ring
 OPTIONAL
 Pag. 312

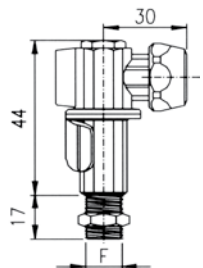
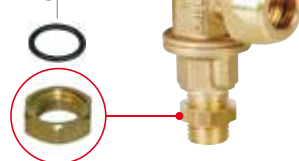

OPTIONALS

Part No. Page

8275019 308

8275020 308



Part No.	DISC	CONE NOZZLE	F	Pack
8264000	1 x Ø18	-	G 1/4 M	
8264001	1 x Ø18	-	G 1/4 F	
8264002	1 x Ø18	-	G 3/8 M	
8264003	-	1 x ATR/MGA	G 1/4 M	10
8264004	-	1 x ATR/MGA	G 1/4 F	
8264005	-	1 x ATR/MGA	G 3/8 M	

Portagello atomizzatore doppio con ghiera

Double nozzle holder with fly nuts

Porte-buses atomiseur 2 écrous



DIMENSIONS

O-Ring
 OPTIONAL
 Pag. 312

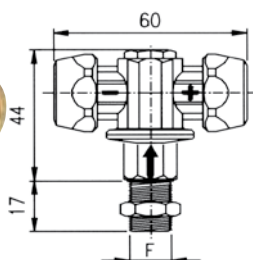

OPTIONALS

Part No. Page

8275019 308

8275020 308



Part No.	DISC	CONE NOZZLE	F	Pack
8265000	2 x Ø18	-	G 1/4 M	
8265001	2 x Ø18	-	G 1/4 F	
8265002	2 x Ø18	-	G 3/8 M	
8265003	1 x Ø18	1 x ATR/MGA	G 1/4 M	10
8265004	1 x Ø18	1 x ATR/MGA	G 1/4 F	
8265005	1 x Ø18	1 x ATR/MGA	G 3/8 M	
8265006	-	2 x ATR/MGA	G 1/4 M	
8265007	-	2 x ATR/MGA	G 1/4 F	
8265008	-	2 x ATR/MGA	G 3/8 M	

Per completare i portagelli, ordinare »
 To complete the nozzles holder, please order »
 A commander pour compléter le porte-buses »

kit piastrelle (Pag. 313-314) / ugelli (cap.6)
 Core kit (Pag. 313-314) / nozzles (cap.6)
 Kit pastilles (Pag. 313-314) / buses (cap.6)



Portaugello atomizzatore doppio con ghiera.

Double nozzle holder with fly nuts.

Porte-buses atomiseur 2 écrous.

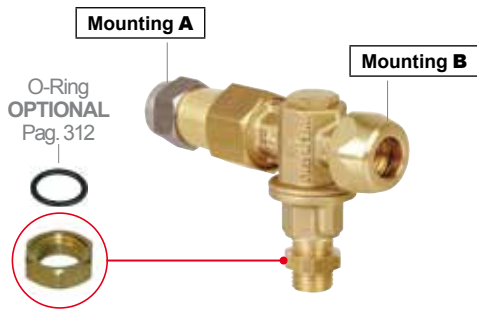

DIMENSIONS

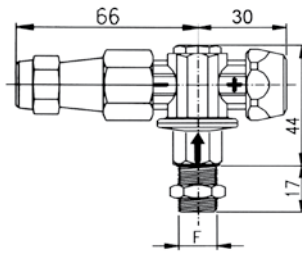

Part No.	DISC (adjustable end)	DISC	F	Pack
8265C0000	1 x Ø15	1 x Ø15	G1/4 M	10
8265C0001	1 x Ø15	1 x Ø15	G3/8 M	

Portaugello atomizzatore doppio regolabile con antigoccia e ghiera.

Double nozzle holder with diaphragm check valve and fly nuts. Adjustable end.

Porte-buses atomiseur réglable 2 sorties avec antigoutte et écrous.

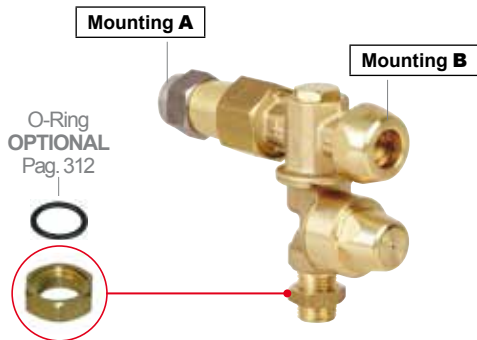

DIMENSIONS

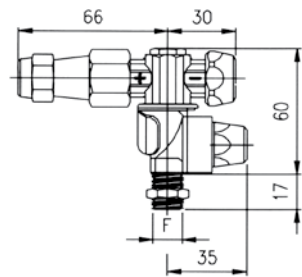

Part No.	DISC (adjustable end)	DISC	F	Pack
8268C0001	1 x Ø15	1 x Ø15	G1/4 M	10
8268C0004	1 x Ø15	1 x Ø15	G1/4 F	

Nebulizzatore leggero registrabile.

Adjustable bent sprayer.

Nébulisateur léger réglable.

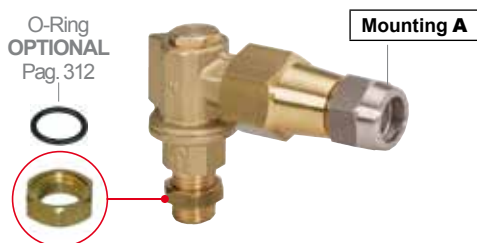

DIMENSIONS

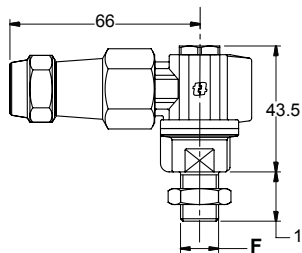

Part No.	DISC (adjustable end)	F	Pack
8264006	1 x Ø15	G 1/4 M	10

Per completare i portaugelli, ordinare piastrine Ø15 mm (Pag. 313)
 To complete the nozzles holder, please order core Ø15 mm (Pag. 313)
 A commander pour compléter le porte-buses pastilles Ø15 mm (Pag. 313)



Portaugello atomizzatore doppio regolabile con antigoccia e ghiera

Double nozzle holder with diaphragm check valve and fly nuts. Adjustable end

Porte-buses atomiseur réglable 2 sorties avec antigoutte et écrous



DIMENSIONS

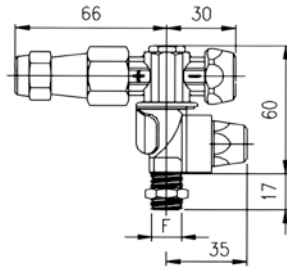

Part No.	DISC (adjustable end)	DISC	CONE NOZZLE	F	Pack
8268009	1 x Ø15	1 x Ø18	-	G 1/4 M	8
8268010	1 x Ø15	1 x Ø18	-	G 1/4 F	
8268011	1 x Ø15	1 x Ø18	-	G 3/8 M	
8268012	1 x Ø15	-	1 x ATR/MGA	G 1/4 M	
8268013	1 x Ø15	-	1 x ATR/MGA	G 1/4 F	
8268014	1 x Ø15	-	1 x ATR/MGA	G 3/8 M	

Portaugello atomizzatore triplo con antigoccia e ghiera

Triple nozzle holder with diaphragm check valve and fly nuts

Porte-buses atomiseur 3 sorties avec anti goutte et écrous



DIMENSIONS

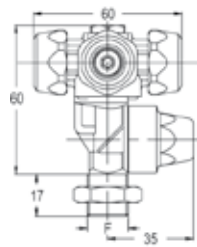

Part No.	DISC	CONE NOZZLE	F	Pack
8269000	3 x Ø18	-	G 1/4 M	8
8269001	3 x Ø18	-	G 1/4 F	
8269002	3 x Ø18	-	G 3/8 M	
8269003	3 x Ø18	-	G 3/8 M - 1/8 F	
8269004	-	3 x ATR/MGA	G 1/4 M	
8269005	-	3 x ATR/MGA	G 1/4 F	
8269006	-	3 x ATR/MGA	G 3/8 M	
8269007	-	3 x ATR/MGA	G 3/8 M - 1/8 F	

Portaugello atomizzatore doppio regolabile con ghiera

Double nozzle holder with fly nuts. Adjustable end

Porte-buses atomiseur réglable 2 sorties avec écrous



DIMENSIONS

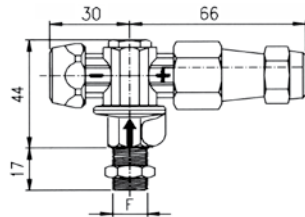

Part No.	DISC (adjustable end)	DISC	CONE NOZZLE	F	Pack
8265009	1 x Ø15	1 x Ø18	-	G 1/4 M	10
8265010	1 x Ø15	1 x Ø18	-	G 1/4 F	
8265011	1 x Ø15	1 x Ø18	-	G 3/8 M	
8265012	1 x Ø15	-	1 x ATR/MGA	G 1/4 M	
8265013	1 x Ø15	-	1 x ATR/MGA	G 1/4 F	
8265014	1 x Ø15	-	1 x ATR/MGA	G 3/8 M	

Portaugello atomizzatore doppio con attacco rapido

Quick fitting double nozzle holder

Porte-buses atomiseur 2 sorties avec raccord rapide



DIMENSIONS

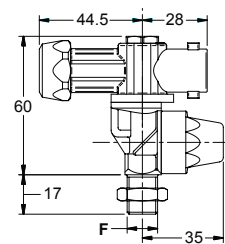

OPTIONALS

Part No.	Type	Pack
8253053	ID/ ISO	25
8253020	ATR/TR	

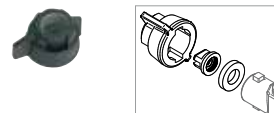

Part No.	DISC	CAP	F	Pack
8268016	1 x Ø18	Quick	G 1/4 M	10
8268017	1 x Ø18	Quick	G 1/4 F	
8268018	1 x Ø18	Quick	G 3/8 M	
8268019	1 x Ø15	Quick	G 1/4 M	
8268020	1 x Ø15	Quick	G 1/4 F	
8268021	1 x Ø15	Quick	G 3/8 M	

Per completare i portaugelli, ordinare »
 To complete the nozzles holder, please order »
 A commander pour compléter le porte-buses »

kit piastrene (Pag. 313-314) / ugelli (cap.6)
 Core kit (Pag. 313-314) / nozzles (cap.6)
 Kit pastilles (Pag. 313-314) / buses (cap.6)



Guarnizioni O-Rings per portaugelli.

O-Ring gaskets for nozzle holder.

Joints toriques pour porte-buses.

NEW

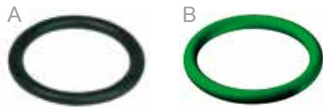

	Part No.	Type	F	Pack
A	G00001093	EPDM	G 1/4	10
B	G00001116	VITON®	G 1/4	10

NEW



	Part No.	Type	F	Pack
A	G00001106	EPDM	G 3/8	10
B	G00001126	VITON®	G 3/8	10

Ghiere in ottone per getti atomizzatore

Brass fly nuts for nozzle holders

Ecrous laiton pour porte-buses atomiseur



Part No.	suitable for DISC / NOZZLE	Pack
8304026	Ø15 mm	10

Part No.	suitable for DISC / NOZZLE	Pack
8270002	Ø15 mm	10
8270000	Ø18 mm	
8270001	ATR / MGA	

ASSEMBLY

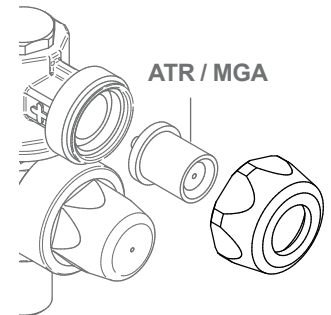

GASKET + DISC + CORE Ø 15

Guarnizione per piastrina inox Ø 15 mm
 Gasket for s/s core Ø 15 mm
 Joint pour pastille inox Ø 15 mm

Piastrina in ceramica Ø 15 mm
 Ceramic disc Ø 15 mm
 Pastille en céramique Ø 15 mm

Convogliatore in acciaio inox Ø 15 mm
 Stainless steel core Ø 15 mm
 Diffuseur en acier inox Ø 15 mm

	Part No.	Pack
1 	G00002032	50

	Part No.	Hole Ø mm	Pack
2 	8259167	0,8	100
	8259168	1,0	100
	8259169	1,2	100
	8259170	1,5	100
	8259171	1,8	100
	8259172	2,0	100

	Part No.	Hole Ø mm	Pack
3 	8259148	blank	100
	8259237	1,2	100
	8259337	1,5	100
	8259338	1,8	100



DISC	CORE	DISC Hole Ø mm	CORE Hole Ø mm	bar	l/1'	Pressure psi	Pack
8259167	8259148	0,8	blank	10	1,17	145	100
				20	1,44	290	
				30	1,76	435	
				40	2,00	580	
				50	2,30	725	
8259168	8259148	1,0	blank	10	1,47	145	100
				20	1,82	290	
				30	2,22	435	
				40	2,54	580	
				50	2,91	725	
8259169	8259148	1,2	blank	10	1,73	145	100
				20	2,14	290	
				30	2,61	435	
				40	2,99	580	
				50	3,43	725	
8259169	8259237	1,2	1,2	10	2,98	145	100
				20	3,70	290	
				30	4,55	435	
				40	5,21	580	
				50	6,00	725	
8259170	8259148	1,5	blank	10	3,22	145	100
				20	3,98	290	
				30	4,83	435	
				40	5,56	580	
				50	6,36	725	
8259170	8259237	1,5	1,2	10	4,79	145	100
				20	5,85	290	
				30	7,03	435	
				40	8,02	580	
				50	9,14	725	
8259170	8259337	1,5	1,5	10	4,77	145	100
				20	5,88	290	
				30	7,11	435	
				40	8,16	580	
				50	9,33	725	
8259171	8259148	1,8	blank	10	2,73	145	100
				20	3,37	290	
				30	4,08	435	
				40	4,68	580	
				50	5,35	725	
8259171	8259337	1,8	1,5	10	6,43	145	100
				20	7,87	290	
				30	9,06	435	
				40	10,63	580	
				50	11,94	725	
8259171	8259338	1,8	1,8	10	6,73	145	100
				20	8,27	290	
				30	10,11	435	
				40	11,51	580	
				50	13,20	725	
8259172	8259148	2,0	blank	10	3,16	145	100
				20	3,92	290	
				30	4,77	435	
				40	5,47	580	
				50	6,28	725	
8259172	8259338	2,0	1,8	10	7,27	145	100
				20	8,96	290	
				30	10,75	435	
				40	12,40	580	
				50	14,14	725	

Assembly - Ø15 Adjustable

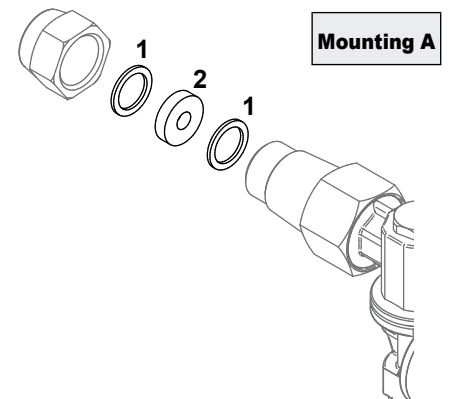

Core kit assembly - Ø15

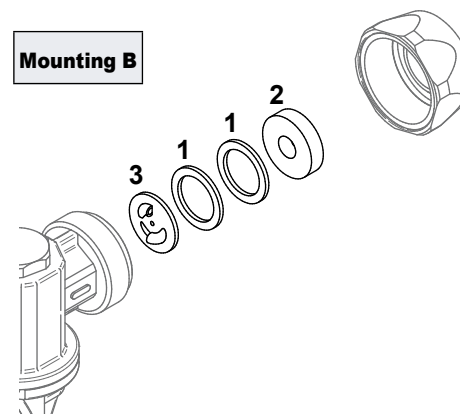

CORE KITS Ø 18

Kit piastrine Ø 18 mm

Core kit Ø 18 mm

Kit pastilles Ø 18 mm



HOW TO ORDER

KIT	TIP mm	CORE mm	bar	l/1'	Pressure psi	Pack
8259211	Ø 0,8	blank	10	1,36	145	25
			20	1,66	290	
			30	2,00	435	
			40	2,28	580	
			50	2,60	725	
8259212	Ø 1,0	blank	10	1,40	145	25
			20	1,71	290	
			30	2,06	435	
			40	2,35	580	
			50	2,68	725	
8259314	Ø 1,0	Ø 1,0	10	1,93	145	25
			20	2,40	290	
			30	2,91	435	
			40	3,35	580	
			50	3,84	725	
8259213	Ø 1,2	blank	10	1,87	145	25
			20	2,31	290	
			30	2,80	435	
			40	3,22	580	
			50	3,68	725	
8259313	Ø 1,2	Ø 1,0	10	3,08	145	25
			20	3,76	290	
			30	4,52	435	
			40	5,16	580	
			50	5,87	725	
8259214	Ø 1,2	Ø 1,2	10	3,16	145	25
			20	3,89	290	
			30	4,73	435	
			40	5,41	580	
			50	6,20	725	
8259215	Ø 1,5	blank	10	2,60	145	25
			20	3,19	290	
			30	3,82	435	
			40	4,40	580	
			50	5,01	725	
8259216	Ø 1,5	Ø 1,2	10	4,41	145	25
			20	5,45	290	
			30	6,61	435	
			40	7,58	580	
			50	8,68	725	
8259217	Ø 1,5	Ø 1,5	10	4,66	145	25
			20	5,74	290	
			30	6,96	435	
			40	7,96	580	
			50	9,11	725	
8259218	Ø 1,8	blank	10	2,84	145	25
			20	3,56	290	
			30	4,35	435	
			40	5,03	580	
			50	5,78	725	
8259219	Ø 1,8	Ø 1,5	10	6,16	145	25
			20	7,40	290	
			30	8,80	435	
			40	9,96	580	
			50	11,28	725	
8259220	Ø 1,8	Ø 1,8	10	6,41	145	25
			20	7,82	290	
			30	9,51	435	
			40	10,78	580	
			50	12,33	725	
8259221	Ø 2,0	blank	10	3,39	145	25
			20	4,23	290	
			30	5,16	435	
			40	5,94	580	
			50	6,83	725	
8259222	Ø 2,0	Ø 1,8	10	7,14	145	25
			20	8,63	290	
			30	10,47	435	
			40	11,79	580	
			50	13,46	725	

ASSEMBLING - Ø18

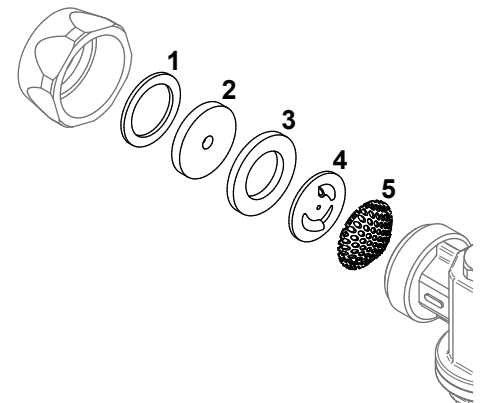

SPARE PARTS

	Part No.	Hole Ø mm	Pack
1	G00002046	/	50
		8259059	0,8 100
		8259060	1,0 100
2	G00002046	8259061	1,2 100
		8259062	1,5 100
		8259063	1,8 100
		8259064	2,0 100
3	G00002022	/	50
		CORE	
4	G00002022	8259067	blank 100
		8259068	1,0 100
		8259069	1,2 100
		8259070	1,5 100
5	G00002022	8259071	1,8 100
		8259073	/ 100

CORE KITS Ø 30

Kit piastrine Ø 30 mm

Core kit Ø 30 mm

Kit pastilles Ø 30 mm



HOW TO ORDER								
KIT	TIP mm	CORE mm	bar	l/1'	Spray angle	Pressure psi	Capacity USG/min'	Pack
8259207	Ø 1,8	Ø 1,5	10	4,95	50°	150	1,32	25
			20	7,00	50°	300	1,80	25
			30	8,60	55°	450	2,20	25
			40	9,90	55°	600	2,60	25

Fino ad esaurimento
 Selling out
 Jusqu'à épuisement

ASSEMBLING - Ø30

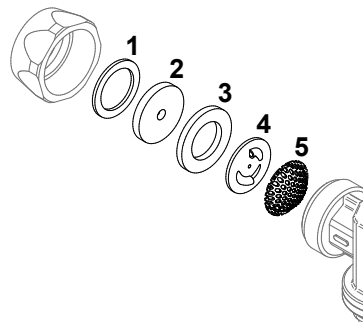

SPARE PARTS

	Part No.	Hole Ø mm	Pack
1	G00002041	/	50
	8259075	1,0	25
2	8259076	1,2	25
	8259079	2,0	25
3	G00001098	/	50
	8259084	1,2	25
4	8259086	1,8	25
5	8259088	/	25

Aste inox AISI 304 Ø1/2", per barre da irrorazione.

AISI 304 stainless steel rods, Ø1/2" for spraying booms.

Tige en acier inoxydable AISI 304 Ø1/2", pour rampes de pulvérisation.

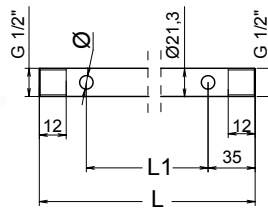

Part No.	L mm	No. of holes	L1 mm	Ø mm	Pack
8292023	800	3	360		
8292022	1000	4	310		
8292024	1000	5	230	7	10
8292025	1200	5	280		
8292026	1400	5	330		
8292027	1600	5	380		

Per completare, ordinare
 To complete, please order
 A commander pour compléter



Pag. 318-319

OPTIONALS



Pag. 316



Pag. 317



Pag. 317

Rubinetti in ottone a sfera.

Brass ball cocks.

Robinets à bille en laiton.



Part No.	Connections	Closing Rotation	Pack
8306002	G 1/2 M	clockwise	↻
	G 3/8 M		
8306003	G 1/2 M	anticlockwise	↺
	G 1/2 M		
8306004	G 1/2 M	anticlockwise	↺
	G 3/8 M		
8306005	G 1/2 M	clockwise	↻
	G 1/2 M		

10



Part No.	Connections	Pack
8306000	G 3/4 F	10
8306001	G 1/2 M	

a farfalla
 t-handle
 papillon

Barre irroranti a T

- Senza portaugelli.
- Fornita smontata.
- Tubi inox Ø 20 mm.

Portaugelli da ordinare separatamente.

T-spraying booms

- Nozzle-holders not included.
- Supplied disassembled.
- Ø 20 mm stainless steel pipes.

Nozzle-holders to be ordered separately.

Rampes de pulvérisation en "T"

- Porte-buses non fournies.
- Livrées en kit d'assemblage.
- Tuyaux en acier inox Ø 20 mm.

Porte-buses à commander séparément.



OPTIONALS



Pag. 316

Part No.	Nozzles	Pack
8290000	3 + 3	5
8290001	4 + 4	5
8290002	5 + 5	5

SPARE PARTS

Part No.	Description	Pack
8294002	Rosetta e molla per barre irroranti. Washer and spring for spraying booms.	10
8294003	Rondelle et ressort pour rampes. Washer and spring for spraying booms.	10



Portaugello per barre con ugello protezione

Nozzle-holder for spraying booms with nozzle and protection

Porte-buse pour rampes avec support et buse

Part No.	Material	Ugello / Nozzle / Buse	Pack
A 8275000	ceramica ceramic céramique	Ugello standard: Ø1,2 mm Standard nozzle: Ø1,2 mm Buse standard: Ø1,2 mm	10

Part No.	Material	Ugello / Nozzle / Buse	Pack
B 8275009	acciaio INOX stainless steel acier INOX	Ugello standard: Ø1,2 mm Standard nozzle: Ø1,2 mm Buse standard: Ø1,2 mm	10

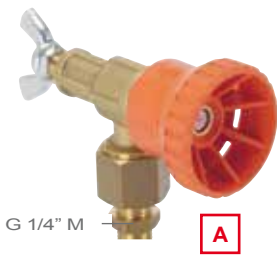

G 1/4" M

A

SPARE PARTS

Part No.	Description	Pack
G00002070	Gasket	50
G00001120	O-Ring	50

OPTIONALS

Description
 Nozzle Pag. 305



G 1/4" M

B

Aste curve inox AISI 304 Ø 20x1mm per gruppi ventola. Si realizzano versioni su disegno per ogni tipo di ventola.

AISI 304 stainless steel curved rods 20x1mm for ventilating fan units. Customized production available on request.

Tiges en acier inox AISI 304 de 20x1mm pour groupes ventilation atomiseur. Autres versions disponible sur demande.

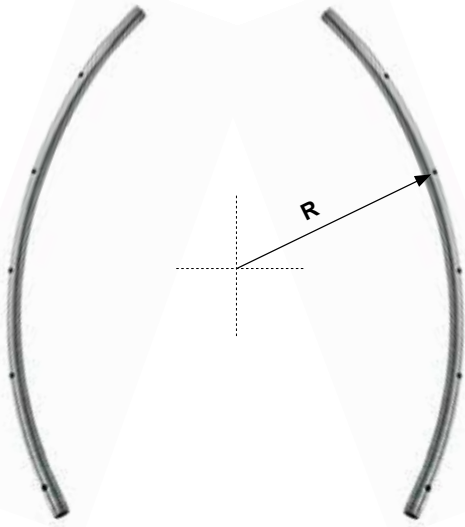

Part No.	ØV mm	R mm	Øe mm	No. of holes	holes Ø	Pack
8290011	600	345	21,3x1	6	7 mm	10
8290012	700	395	21,3x1	7	7 mm	10
8290013	800	445	21,3x1	7	7 mm	10
8290014	900	495	21,3x1	7	7 mm	10
8290015	1000	545	21,3x1	7	7 mm	10

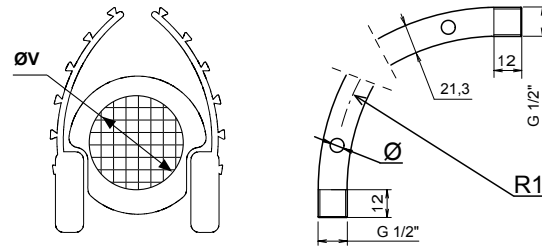

Per completare, ordinare
 To complete, please order
 A commander pour compléter



Pag. 318-319

OPTIONALS



Pag. 309



Pag. 317



Pag. 317

Morsetto in ottone nichelato con o-ring di tenuta per tubi Ø 20mm (1/2").

Nickel-plated brass clamp with o-ring gasket for rods Ø 20mm (1/2").

Brides de serrage en laiton nickelé avec joint torique. Pour tuyaux de Ø 20mm (1/2").

Part No.	F1	D mm	H mm	Pack
8272000	G 1/4 F 20 -1/2"G	30	30	25
8272001	G 1/4 F 20 -1/2"G	37,5		

Part No.	F1	D mm	H mm	Pack
8272006	G 1/4 M 20 -1/2"G	30	30	25

Part No.	F1	D mm	H mm	Pack
8272007	G 3/8 M 20 - G1/2	37,5	25	
8272008	G 1/2 M 20 - G1/2	49	25	

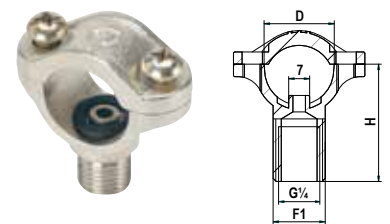
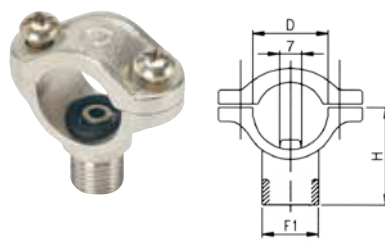
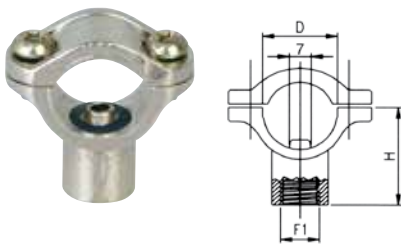

Morsetto in ottone nichelato con cavallotto filettato e o-ring di tenuta per tubi Ø 20mm (1/2").

Nickel-plated brass clamp with o-ring gasket. Mounting hole of Ø 20mm (1/2").

Brides de serrage en laiton nickelé avec joint torique et trou de fixation. Pour tuyaux de Ø 20mm (1/2").

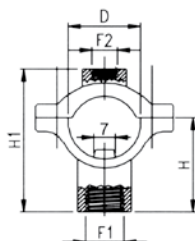

Part No.	F1	F2	D mm	H mm	H1 mm	Pack
8272002	G 1/4 F	M8	20 -1/2"G	30	45,3	25
8272003	G 1/4 F	M8	20 -1/2"G	37,5	52,8	

Raccorderia in ottone

Brass fittings

Raccords en laiton

Tappo femmina
 Female plug
 Bouchon femelle

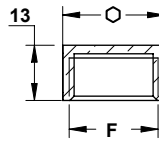

Part No.	F		Pack
8304022	G 1/2"	24	25
8304069	G 1/2"	24	25 with gasket

Tappo maschio
 Male plug
 Bouchon male

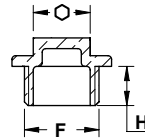

Part No.	F	H mm		Pack
8304050	G 1/4"	8	10	25
8304051	G 3/8"	10	15	
8304052	G 1/2"	11	16	
8304000	G 3/4"	12	32	

Nipplo
 Nipple
 Nipple

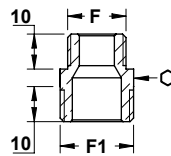

Part No.	F	F1		Pack
8304009	G 3/8"	G 1/2"	21	25
8304010	G 1/2"	G 1/2"	21	25
8304057	G 3/4"	G 3/4"	32	25
8304086	G 1"	G 1"	36	10

Giunto autobloccante con girello
 Self-locking union with fly nut
 Raccord à blocage automatique avec écrou fileté

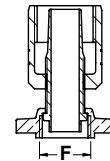

Part No.	Hose Ø mm	F	Pack
8308006	10x17		10
8308007	10x19		
8308008	10x21	G 1/2"	
8308009	13x24		

Portagomma curvo con girello
 Elbow hosetail with fly nut
 Raccord coudé avec écrou fileté

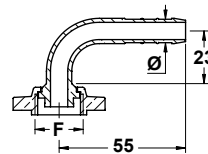

Part No.	Ø mm	F	Pack
8304007	10	G 1/2"	25
8304008	13	G 1/2"	

Portagomma curvo con ghiera
 Elbow hosetail with nut
 Raccord coudé avec écrou fileté

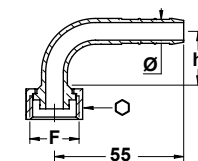

Part No.	Ø mm	F	h mm		Pack
8304037	10	G 1/2"	23	24	25
8304038	13	G 1/2"	26,5	24	

Portagomma diritto con girello
 Hosetail with fly nut
 Raccord droit avec écrou fileté

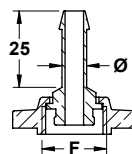

Part No.	Ø mm	F	Pack
8304003	8	G 1/2"	50
8304004	10	G 1/2"	
8304005	13	G 1/2"	

Portagomma diritto con ghiera
 Hosetail with fly nut
 Raccord droit avec écrou fileté

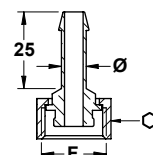

Part No.	Ø mm	F		Pack
8304054	8	G 1/2"	24	50
8304055	10	G 1/2"	24	
8304056	13	G 1/2"	24	

Raccorderia in ottone

Brass fittings

Raccords en laiton

Portagomma filettato
 Threaded hosetail
 Porte-tuyau fileté

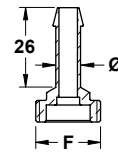

Part No.	Ø mm	F	Pack
8304011	8	G 1/2"	
8304012	10	G 1/2"	50
8304013	13	G 1/2"	

Giunto semplice diritto
 Simple union
 Racord de jonction droit

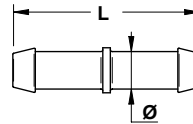

Part No.	Ø mm	L mm	Pack
8308003	8	45	
8308004	10	50	25
8308005	13	50	

Giunto combinato pesante
 Heavy combined union
 Racord de jonction combiné lourd

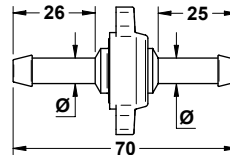

Part No.	Ø mm	Pack
8308000	8	
8308001	10	25
8308002	13	

Girello
 Fly nut
 Ecrou

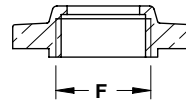

Part No.	F	Pack
8304006	G 1/2"	25

Ghiera
 Nut
 Ecrou

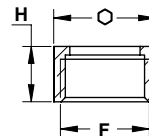

Part No.	F	H mm	Wrench Icon	Pack
8304036	G 1/2"	13	24	25
8304039	G 3/4"	18	32	10

Guarnizione per raccordo con girello
 Gasket for swivel fitting
 Joint pour raccord tournant



Part No.	Ø	Pack
G00002035	1/2"	50

Nipplo per barre irroranti
 Nipple for spraying booms
 Nipple pour rampes de pulvérisation

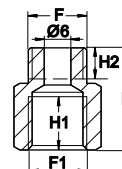

Part No.	F	F1	L mm	H mm	H12 mm	Wrench Icon	Pack
I00000003	G1/4	G1/4	23	12	7	17	1
I00000004	G1/4	G1/4	30	16	7	17	

Nipplo per barre irroranti
 Nipple for spraying booms.
 Nipple pour rampes de pulvérisation.

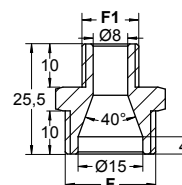

Part No.	F	F1	Wrench Icon	Pack
I00000005	G1/2	G1/4	22	1

Raccorderia in ottone

Brass fittings

Raccords en laiton

Curva in ottone
 Brass elbow
 Raccord coudé en laiton

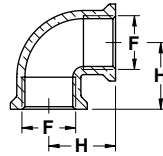

Part No.	F	H mm	Pack
8304046	3/8"	21,5	25
8304047	1/2"	26,0	
8304048	3/4"	28,5	
8304049	1"	37,0	

Curva in ottone
 Brass elbow
 Raccord coudé en laiton

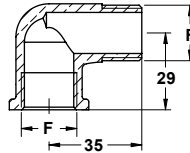

Part No.	F	Pack
8304031	1/2"	25

Curva in ottone
 Brass elbow
 Raccord coudé en laiton

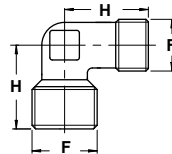

Part No.	F	H mm		Pack
R0000072	G 3/4 - G 1/2	34,0	19	25
R0000073	G 3/4 - G 3/4	40,0	27	

Giunto a 3 vie in ottone.
 Brass 3-way union.
 Raccord 3 voies en laiton.

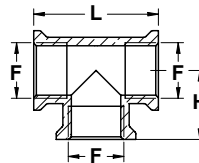

Part No.	F	H mm	L mm	Pack
8304043	1/2"	26,0	47	25
8304044	3/4"	28,5	57	
8304045	1"	37,0	73	

Giunto a 3 vie in ottone.
 Brass 3-way union.
 Raccord 3 voies en laiton.

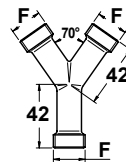

Part No.	F	Pack
8304027	1/2"	25

Giunto a 3 vie in ottone.
 Brass 3-way union.
 Raccord 3 voies en laiton.

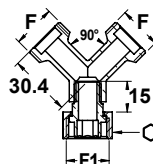

Part No.	F	F1		Pack
8304040	1/2"M	1/2"F	24	25

Raccorderia

Fittings

Raccords

Raccordi a "L"
 "L" fittings
 Raccords en "L"



Part No.	A	B	Pack
R0000301	G 1/4 F	G 1/4 F	25
R0000302	G 3/8 F	G 3/8 F	25
R0000303	G 1/4 F	G 1/2 F	25
R0000304	G 1/4 M	G 1/4 M	25
R0000305	G 3/8 M	G 3/8 M	25
R0000306	G 1/2 M	G 1/2 M	25
R0000307	G 3/8 M	G 1/4 M	25
R0000308	G 1/2 M	G 3/8 M	25
R0000309	G 1/4 F	G 1/4 M	25
R0000310	G 3/8 F	G 3/8 M	25
R0000311	G 1/2 F	G 1/2 M	25
R0000312	G 3/8 F	G 1/4 M	25
R0000313	G 1/4 F	G 3/8 M	25

Raccordi a "T"
 "T" fittings
 Raccords en "T"

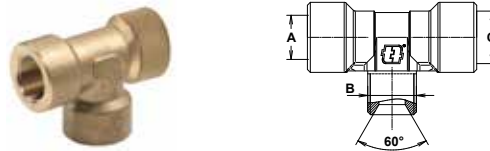

Part No.	A	B	C	Pack
R0000314	G 1/2 F	G 1/2 F	G 1/2 F	25
R0000315	G 3/8 F	G 3/8 F	G 3/8 F	25
R0000316	G 3/8 F	G 3/8 M	G 3/8 F	25
R0000317	G 3/8 F	G 3/8 F	G 3/8 M	25
R0000318	G 3/8 F	G 1/4 M	G 3/8 F	25
R0000319	G 3/8 F	G 1/4 F	G 3/8 F	25
R0000320	G 3/8 F	G 1/4 F	G 3/8 M	25

Nipplo in ottone zincato
 Zinc plated brass nipple
 Nipple en laiton zingué



Part No.	INLET	OUTLET		Pack
0115710100	G 1/4 M	G 1/4 F	22	25
0115710070	G 1/4 F	G 1/4 F	22	25
0115710060	G 1/4 F	G 3/8 M	22	25
0115710020	G 3/8 F	G 1/4 F	22	25
0115710110	G 1/2 F	G 1/4 F	24	25
0115710140	G 1/2 M	G 1/4 F	22	25

Nipplo in ottone
 Brass nipple
 Nipple en laiton.



Part No.	INLET	OUTLET		Pack
R0000220	R 1/4 M	R 1/4 M	14	25
R0000212	G 3/8 F	G 1/4 F	22	25
150090	G 3/8 F	G 3/8 F	22	25
110007	G 3/8 M	G 1/4 M	19	25
110008	G 3/8 M	G 3/8 M	19	25

Nipplo in acciaio inox
 Stainless steel nipple
 Nipple en acier inox



Part No.	INLET	OUTLET		Pack
N00200008	G 1/4 F	G 1/4 F	17	25

Nipplo in acciaio zincato
 Zinc plated steel nipple
 Nipple en acier zingué



Part No.	INLET	OUTLET		Pack
R0000158	G 3/8 F	G 1/4 F	22	25
410001	G 3/8 M	G 1/4 M	19	25
410000	G 3/8 M	G 3/8 M	19	25

Coperchi in gomma (chiusi).
 Rubber lids (closed).
 Couvertres en caoutchouc (fermés).

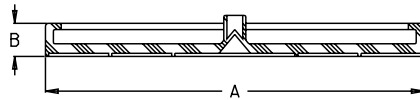

Part No.	A mm	B mm	Pack
8184000	265	20	
8184001	365	20	10
8184002	454	22	

Passatubi in gomma.
 Rubber pipe duct.
 Canalisation en caoutchouc.

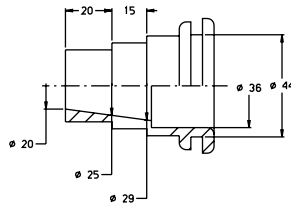

Part No.	Type	Pack
8316000	Type 1	10

Passatubi in gomma.
 Rubber pipe duct.
 Canalisation en caoutchouc.

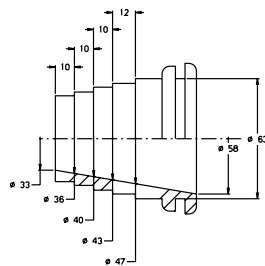

Part No.	Type	Pack
8316001	Type 2	10

Avvolgitubo manuale in alluminio pressofuso.
 - Supporti laterali, rullo centrale e asse centrale in acciaio verniciato;
 - Dischi laterali in alluminio verniciato a polvere ad alta resistenza antiurto;
 - Giunti girevoli in acciaio inox e boccole in materiale plastico autolubrificante;
 - Blocco anti-srotolamento con pomello, manopola ergonomica e due fascette ferma tubo

Die casting aluminium manual hose-reel.
 - Side supports, central roller and central axis in painted steel;
 - Side discs in powder painted die-cast aluminum;
 - Stainless steel swivels and self-lubricating plastic bushings;
 - Anti-roll lock with knob, ergonomic handle and two clamps to fasten the hose

Enrouleur manuel en aluminium moulé sous pression.
 - Supports latéraux, rouleau central et axe centrale en acier laqué;
 - Disques latéraux laqués en poudre d'aluminium à haute résistance aux chocs;
 - Rotules en acier inoxydable et coquilles en matière plastique autolubrificante;
 - Blocage anti-déroulement avec bouton, poignée ergonomique et deux colerettes arrête-tube



Fino ad esaurimento
 Selling out
 Jusqu'à épuisement

Fino ad esaurimento
 Selling out
 Jusqu'à épuisement

Fino ad esaurimento
 Selling out
 Jusqu'à épuisement

Part No.	bar	INLET	OUTLET	HOSE CAPACITY		Pack
				Ø mm	LENGTH m	
HR50 4131800003	300	G 3/8 M	G 3/8 M	15,0	100	13 1
				16,8	80	
				17,8	75	
				19,5	58	
HR50 4131800004	200	G 1/2 M	G 1/2 M	15,0	100	13 1
				16,8	80	
				17,8	75	
				19,5	58	
HR70 4131800005	100	G 3/8 M	G 3/8 M	17,0	85	11,5 1
				19,0	70	
				20,0	62	
				21,0	56	
				24,0	45	
HR70 4131800006	100	G 1/2 M	G 1/2 M	17,0	85	11,5 1
				19,0	70	
				20,0	62	
				21,0	56	
				24,0	45	
HR50L 4131800016	300	G 3/8 M	G 3/8 M	15,0	130	14,5 1
				16,8	100	
				17,8	95	
				19,5	75	
				17,0	110	
HR70L 4131800017	100	G 1/2 M	G 1/2 M	19,0	90	12,5 1
				20,0	80	
				21,0	72	
				24,0	55	

Note: tubo escluso
 Notes: without pipe
 Remarques: Tube exclus

Avvolgitubo manuale

- Flange in lamiera verniciata
- Cilindro in lamiera verniciata
- Base in tubolare verniciato
- Giunti girevoli in ottone
- Pressione max 80 bar
- Entrata filettata G 1/2 M

Manual hose reel

- painted sheet discs
- painted sheet steel cylinder
- painted sheet steel frame
- Brass swivel fittings
- Max pressure 80 bar
- BSP 1/2 M threaded inlet

Enrouleur manuel

- Disques en tôle peinte
- Cylindre en tôle d'acier peinte
- Chassis en tube d'acier peint
- Joints tournants en laiton
- Pression maxi 80 bar
- Entrée filetée mâle G 1/2 M.



Part No.	INLET bar	OUTLET	HOSE CAPACITY		A mm	B mm	C mm	D mm	E mm	
			Ø mm	LENGTH m						
8214000	80	G 12 M	G 12 M	18,0	50	492	200	47,8	195,5	397

DIMENSIONS

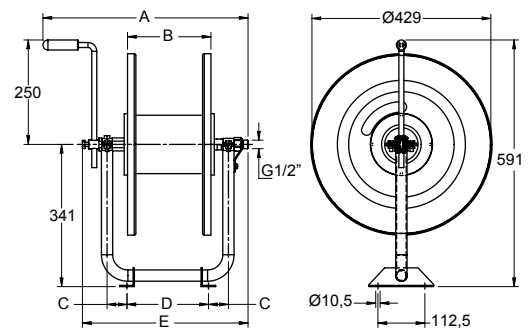

Avvolgitubo manuale.
 Fornito smontato.

Manual hose reels.
 Supplied disassembled.

Enrouleur manuel.
 Livré en kit d'assemblage.



Fino ad esaurimento
 Selling out
 Jusqu'à épuisement

Part No.	INLET bar	OUTLET	HOSE CAPACITY		A mm	B mm	
			Ø mm	LENGTH m			
8214003	100	G 1/2	G 1/2	18,0	100	352	232
8214004	100	G 1/2	G 1/2	18,0	150	447	327
8214007	150	G 3/8	G 3/8	18,0	100	352	232

DIMENSIONS

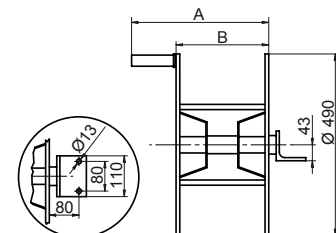

Avvolgitubo manuale

- Bobina in polipropilene rinforzata con fibra di vetro
- Telaio in acciaio zincato
- Snodo girevole in ottone
- Capacità 50 m, tubo Ø18 mm
- Pressione max di lavoro 100 Bar

Manual hose reel

- Fiberglass-reinforced polypropylene reel
- Galvanised steel frame
- Brass swivel fitting
- Capacity 50 m, hose Ø 18 mm
- Max. working pressure 100 Bar

Enrouleur manuel

- Cylindre en polypropylène renforcé avec fibre de verre
- Chassis en acier galvanisé
- Joints tournant en laiton
- Capacité 50 m de tuyau Ø 18 mm
- Pression de travail maxi 100 bar



Part No.	bar	INLET	OUTLET	HOSE CAPACITY	
				Ø mm	LENGHT m
8214002	100	G 1/2	G 1/2	18,0	50

DIMENSIONS

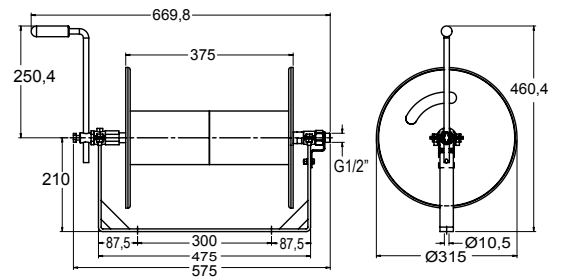

Tubo in PVC rinforzato.
 Reinforced PVC pipe.
 Tuyau en PVC renforcé.



Part No.	d mm	D mm	WORKING PRESS.	BURSTING PRESS.	COLOUR	Order multiples of
8296000	8	13	20 bar (290 psi)	75 bar (1090 psi)	Beige	100 m
8296001	10	15	20 bar (290 psi)	75 bar (1090 psi)	Beige	100 m
8296014	13	19	20 bar (290 psi)	60 bar (870 psi)	Beige	100 m
8296007	19	26,5	20 bar (290 psi)	55 bar (798 psi)	Beige	100 m
8296008	25	33,5	20 bar (290 psi)	50 bar (725 psi)	Beige	50 m
8296002	8	14	40 bar (580 psi)	120 bar (1740 psi)	Blue	100 m
8296003	10	16	40 bar (580 psi)	120 bar (1740 psi)	Blue	100 m
8296015	13	21	40 bar (580 psi)	120 bar (1740 psi)	Blue	100 m
8296004	8	15	80 bar (1160 psi)	270 bar (3915 psi)	Red	100 m
8296005	10	18	80 bar (1160 psi)	270 bar (3915 psi)	Red	100 m
8296006	13	21	80 bar (1160 psi)	270 bar (3915 psi)	Red	100 m

Manometri alla glicerina

Glycerin pressure gauges

Manomètres à la glycerine

WIKAI

Part of your business



ABS Ø=63 mm
 F=G1/4"

Part No.	RANGE	Pack
8302002	0÷10 bar	5
8302004	0÷25 bar	5
8302006	0÷40 bar	5
8302009	0÷100 bar	5



ABS Ø=63 mm
 F=G1/4"

Part No.	RANGE	Pack
8302050	0÷4 bar	5
8302051	0÷6 bar	5
8302052	0÷10 bar	5
8302053	0÷16 bar	5
8302054	0÷25 bar	5
8302055	0÷30 bar	5
8302056	0÷40 bar	5
8302057	0÷60 bar	5
8302058	0÷80 bar	5
8302059	0÷100 bar	5



INOX Ø=63 mm
 F=G1/4"

Part No.	RANGE	Pack
8302100	0÷4 bar	5
8302101	0÷6 bar	5
8302102	0÷10 bar	5
8302103	0÷16 bar	5
8302104	0÷25 bar	5
8302106	0÷40 bar	5
8302107	0÷60 bar	5
8302109	0÷100 bar	5



INOX Ø=100 mm
 F=G1/2"

Part No.	RANGE	Pack
8302154	0÷25 bar	3
8302156	0÷40 bar	3
8302157	0÷60 bar	3

* Adatto per scatole di comando.
 Suitable for control panels.
 Adapte pour les boîtiers de commande



Manometri isometrici alla glicerina

Glycerin isometric pressure gauges

Manomètres isométriques à la glycerine

WIKAI

Part of your business



INOX Ø=63 mm
 F=G1/4"

Part No.	RANGE	Pack
8302200	0÷5/25 bar	5
8302201	0÷15/60 bar	5



INOX

Part No.	RANGE	Ø e mm	F	Pack
8302250	0÷5/25 bar	63	G 1/4	5
8302251	0÷15/60 bar	63	G 1/4	5
8302401	0÷15/60 bar	100	G 1/4	5



INOX

Part No.	RANGE	Ø e mm	F	Pack
8302300	0÷25 bar	100	G 1/2	5
8302400	0÷5/25 bar	100	G 1/4	5

* Adatto per scatole di comando.
 Suitable for control panels.
 Adapte pour les boîtiers de commande



Protezione in gomma per manometro

Protective rubber case

Protection en caoutchouc pour manomètre



Part No.	Ø mm	Pack
P00600007	63	5

Sensore di pressione

Pressure sensor

Capteur de pression



Part No.	L (m)	bar	mA	V dc	Pack
S02000026		20			
S02000010	5,0	50	4-20	12	1
S02000011		100			

Adatto per / Suitable to / Approprié à

GS 250 GS 260 GS 220 GS 210 GS 200

NOTE

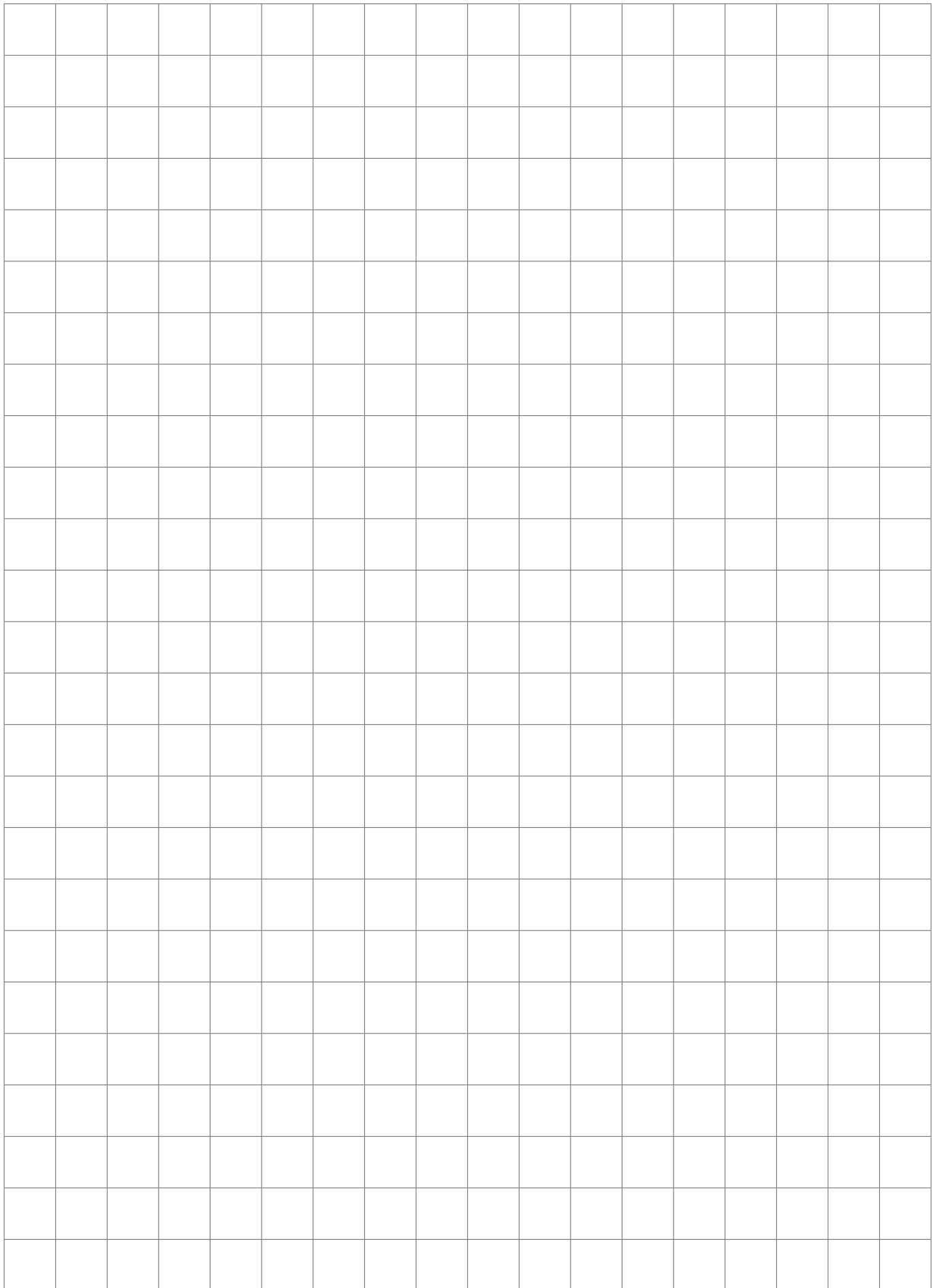

CONDIZIONI GENERALI DI VENDITA

CONDIZIONI GENERALI DI VENDITA

Art. 1 - Ambito di applicazione delle condizioni generali di vendita

1.1 Le presenti condizioni generali di vendita (di seguito le "Condizioni") si applicano a ogni contratto di vendita (di seguito il "Contratto") concluso da Tecomec (di seguito il "Venditore") ed avente ad oggetto i prodotti fabbricati e/o commercializzati dal Venditore (di seguito i "Prodotti").

1.2 Nonostante qualunque previsione contraria, anche se contenuta nelle eventuali condizioni generali dell'acquirente dei Prodotti (di seguito l'"Acquirente"), ogni offerta, conferma d'ordine e/o consegna da parte del Venditore si intende regolata dalle seguenti Condizioni, salvo patto contrario specificatamente accettato di volta in volta per iscritto dal Venditore.

Art. 2 - Conclusione ed entrata in vigore del Contratto

2.1 Il Contratto di vendita dei Prodotti si intende concluso (i) nel momento di emissione della relativa conferma d'ordine da parte del Venditore o, in mancanza di tale conferma, (ii) nel momento del ritiro dei Prodotti da parte dell'Acquirente.

2.2 Gli ordini dell'Acquirente saranno accettati dal Venditore solo a condizione che contengano le specifiche necessarie ad identificare i Prodotti ordinati, restando inteso che il Venditore si riserva la facoltà di accettare o rifiutare gli ordini dell'Acquirente a proprio insindacabile giudizio.

2.3 Eventuali annullamenti o modifiche dell'ordine da parte dell'Acquirente, successivi alla conclusione del Contratto di cui al precedente art. 2.1, non avranno effetto se non preventivamente autorizzati o successivamente accettati per iscritto dal Venditore (fermo restando che in nessun caso agenti, intermediari e/o collaboratori esterni del Venditore hanno il potere di accettare per conto di quest'ultimo gli ordini di acquisto dell'Acquirente e/o di formulare o accettare, in modo vincolante per il Venditore, proposte relative a sconti, abbuoni e/o condizioni derogative alle presenti Condizioni).

Art. 3 - Modalità di pagamento - Prezzi

3.1 Se non altrimenti convenuto per iscritto, ad ogni ordine si applicano i prezzi di listino praticati dal Venditore al momento della conferma d'ordine. I prezzi di eventuali Prodotti non riportati a listino saranno determinati di volta in volta dal Venditore.

3.2 I prezzi dei Prodotti si intendono al netto di IVA e di ogni altra spesa e/o onere accessorio (quali, in via esemplificativa e non limitativa, spese e/o commissioni bancarie, imballo speciale, assicurazione, trasporto), che devono intendersi quindi a carico dell'Acquirente.

Fermo quanto precede, le imposte, le tasse, i tributi, le licenze, le autorizzazioni, i permessi ed ogni e qualsivoglia costo o adempimento fiscale, doganale ed amministrativo da cui dipendano l'importazione e/o la rivendita dei Prodotti devono ritenersi ad esclusivo carico dell'Acquirente ovvero svolte dal Venditore sotto l'esclusiva responsabilità dell'Acquirente ed a rischio e spese di quest'ultimo.

3.3 Salvo diversa indicazione scritta nella conferma d'ordine, il pagamento del prezzo dei Prodotti sarà effettuato entro 30 (trenta) giorni dalla data di emissione della fattura.

Per nessun motivo l'Acquirente potrà ritardare o sospendere i pagamenti del prezzo dei Prodotti. Qualora l'Acquirente non adempia regolarmente ai propri obblighi di pagamento del prezzo (compreso l'inadempimento dell'obbligo di versare gli eventuali anticipi), il Venditore avrà la facoltà di prorogare i termini di consegna pattuiti per un periodo corrispondente al ritardo dell'Acquirente e/o di risolvere il Contratto, ritenendo come penale le somme pagate dall'Acquirente, salva in ogni caso la risarcibilità del danno ulteriore.

Art. 4 - Termini di consegna ed imballo

4.1 Tutte le date indicate nelle conferme d'ordine come termini di consegna si intendono puramente indicative. Eventuali ritardi nella consegna non daranno diritto all'Acquirente alla risoluzione del Contratto, né al risarcimento dei danni di qualsiasi natura (fermo in ogni caso restando che l'Acquirente, mediante il ritiro della consegna tardiva, rinuncia a qualsivoglia pretesa in relazione al ritardo).

4.2 Salvo diverso accordo scritto tra le parti, la consegna dei Prodotti (così come il passaggio del relativo rischio) ha luogo secondo la formula "EX WORKS - franco fabbrica venditore" (Incoterms 2000); per effetto di quanto precede, il Venditore non stipulerà alcun contratto di spedizione o trasporto e non assicurerà i Prodotti oggetto di fornitura se non dietro espresso ordine dell'Acquirente, restando in ogni caso a carico di quest'ultimo tutti i conseguenti oneri e rischi.

4.3 L'Acquirente si impegna a ritirare i Prodotti immediatamente dopo aver ricevuto la comunicazione di merce pronta e comunque non oltre 8 (otto) giorni dalla data della predetta comunicazione. Il passaggio del rischio comincerà in ogni caso a decorrere dalla predetta data di avviso di merce pronta ovvero, solo in mancanza di questa, dalla data di consegna.

4.4 All'atto della consegna dei Prodotti, l'Acquirente è tenuto a controllarne numero e tipologia. Qualsiasi reclamo da parte dell'Acquirente in relazione alla quantità e alla qualità dei Prodotti consegnati deve pervenire in forma scritta al Venditore entro e non oltre 8 (otto) giorni dalla data di consegna dei Prodotti stessi.

4.5 I Prodotti sono consegnati dal Venditore all'Acquirente muniti di imballo adeguato. Resta inteso che il Venditore fornisce un imballo idoneo ad una permanenza delle merci in deposito/transito per un periodo non superiore a 180 (centottanta) giorni; qualora l'Acquirente comunichi con sufficiente anticipo che le merci potranno essere in deposito/transito per un periodo superiore a 180 (centottanta) giorni, il Venditore potrà fornire a spese dell'Acquirente un diverso imballo.

4.6 Con la consegna dei Prodotti, l'Acquirente si impegna a custodire con la dovuta diligenza i Prodotti ricevuti (conservandoli in luogo sicuro ed idoneo e facendo in modo che i Prodotti non siano sottoposti a condizioni climatiche e temperature inadeguate), posto che la proprietà dei Prodotti passerà all'Acquirente solo in seguito al saldo integrale del prezzo.

In caso di mora dell'Acquirente nel pagamento del prezzo, il Venditore potrà, senza necessità di alcuna formalità, compresa la messa in mora, riprendere possesso di tutti i Prodotti oggetto di riservato dominio ovunque essi si trovino, nonché addebitare gli interessi di mora nella misura prevista dalla legge applicabile in materia (fermo restando il diritto del Venditore a ricorrere ad ogni ulteriore rimedio di legge circa il pregiudizio subito).

Art. 5 - Caratteristiche dei Prodotti; Modifiche ai Prodotti

5.1 Eventuali informazioni o dati sulle caratteristiche e/o specifiche tecniche dei Prodotti contenuti nei depliant, listini prezzi, cataloghi, o documenti similari sono puramente indicativi e non vincolanti, salvo espresso accordo scritto in tal senso tra le parti.

5.2 L'Acquirente non potrà effettuare, direttamente o indirettamente, alcuna modifica, cambiamento o qualsiasi altra alterazione dei Prodotti e sopporterà ogni e più ampia responsabilità in relazione ai Prodotti, sia essa prevedibile o non prevedibile, derivante dal Contratto, da fatto illecito, da equità o altro, nel caso di suo inadempimento alle sopra citate obbligazioni.

5.3 Fermo restando quanto precede, il Venditore si riserva, a proprio insindacabile giudizio, il diritto di aggiornare, modificare e/o terminare la produzione di tutte o alcune tipologie di Prodotti.

A tale riguardo, l'Acquirente riconosce ed accetta altresì che i cambiamenti della tecnologia, delle condizioni di mercato o della politica delle vendite del Venditore consentono al Venditore stesso di modificare le specifiche di un Prodotto o di cessare la produzione e/o la vendita di uno o più tipologie di Prodotto. Resta comunque inteso che il Venditore non sarà in nessun caso ritenuto responsabile nei confronti dell'Acquirente e/o di terzi per gli eventuali danni, diretti o indiretti, che possano prodursi a seguito di una decisione del Venditore in tal senso.

Art. 6 - Responsabilità

6.1 Fermo restando le limitazioni della garanzia del Venditore di cui al successivo art. 7, in nessun caso la responsabilità complessiva del Venditore potrà eccedere il 7% (sette per cento) del prezzo pattuito in relazione ai Prodotti oggetto di contestazione.

6.2 L'Acquirente si impegna a prendere visione e conoscenza delle caratteristiche tecniche dei Prodotti, nonché delle istruzioni e delle avvertenze fornite in relazione all'uso che si può fare dei suddetti Prodotti ed al quale i medesimi Prodotti possono essere ragionevolmente destinati. Oltre a ciò, l'Acquirente si impegna a fare in modo che i Prodotti siano commercializzati unicamente a partire dal momento in cui i medesimi Prodotti rispettino tutte le leggi, i regolamenti e le altre normative (relative a imballi, istruzioni, informazioni e, più in generale, alla sicurezza delle cose e delle persone) previste dall'ordinamento del Paese in cui i Prodotti vengono commercializzati. Spetterà pertanto esclusivamente all'Acquirente - che si impegna pertanto a manlevare ed a tenere pienamente indenne il Venditore con riferimento a quanto previsto dal presente art. 6.2 - assicurare che l'utilizzo e la commercializzazione dei Prodotti risulti corretto e conforme alle suddette norme nonché alle esigenze della propria clientela ed alla buona tecnica.

Art. 7 - Garanzia

7.1 Il Venditore garantisce la qualità dei Prodotti per un periodo di 12 (dodici) mesi dalla consegna, salvo le tolleranze d'uso ed esclusi quei difetti che possano manifestarsi a causa del trasporto, di un uso improprio o di una inadeguata conservazione o manutenzione dei Prodotti. Dalla presente garanzia sono esclusi tutti gli ulteriori danni, ivi compresi quelli derivanti dalla mancata o ridotta produzione, nonché quelli indiretti e consequenziali, speciali, incidentali e/o di carattere sanzionatorio.

7.2 La garanzia è subordinata, a pena di decadenza, alla denuncia del vizio o della mancanza di qualità, comunicata in forma scritta al Venditore, entro 8 (otto) giorni dal momento in cui l'Acquirente ne ha fatto la scoperta, nonché all'espressa richiesta, sempre comunicata nelle forme indicate, al Venditore di effettuare un intervento in garanzia.

7.3 La garanzia consiste, a scelta del Venditore, nella riparazione o sostituzione, a cura e spese del Venditore, dei Prodotti che risultino rotti o difettosi per vizi di origine. Il Venditore provvede alla sostituzione ovvero alla riparazione nel più breve tempo possibile (da stabilire di volta in volta) ed ha facoltà di richiedere all'Acquirente la restituzione delle parti e/o dei Prodotti sostituiti.

7.4 Ogni diversa garanzia in relazione ai Prodotti, anche di legge, deve ritenersi esclusa e superata dalle presenti Condizioni.

Art. 8 - Resi

8.1 I Prodotti potranno essere resi dall'Acquirente al Venditore solo previa autorizzazione del Venditore stesso. Resta in ogni caso inteso che, in assenza del ritiro dei Prodotti, da parte dell'Acquirente, entro 6 (sei) mesi dalla data del relativo reso al Venditore (a prescindere dal fatto che si tratti di resi non autorizzati o di Prodotti fuori garanzia), il Venditore si riserva la facoltà di rottamare i Prodotti in questione e di addebitare all'Acquirente il costo di tale operazione, fermo restando in ogni caso il diritto del Venditore al rimborso del costo del deposito dei Prodotti resi.

Art. 9 - Forza maggiore

9.1 Il Venditore non è responsabile nei confronti dell'Acquirente di alcun inadempimento, compresa la mancata o ritardata consegna, causato da accadimenti al di fuori del proprio ragionevole controllo o comunque riconducibili a caso fortuito o a forza maggiore, quali, a titolo meramente indicativo, mancata o ritardata consegna dei materiali di lavorazione da parte dei fornitori, scioperi ed altre azioni sindacali, sospensione dell'energia elettrica o difficoltà nei trasporti.

9.2 Al verificarsi di un evento di forza maggiore gli obblighi delle parti che non possano essere adempiuti per tale causa sono automaticamente prorogati, senza penalità a carico, per un periodo corrispondente alla durata dello stato di forza maggiore; quanto precede, ad eccezione dell'obbligo dell'Acquirente di corrispondere le somme dovute a titolo di pagamento del prezzo, per il quale restano in ogni caso ferme le scadenze precedentemente pattuite.

Art. 10 - Legge applicabile e foro competente

10.1 Le presenti Condizioni e tutti i contratti di vendita di cui siano parte il Venditore e l'Acquirente sono esclusivamente regolati dalla legge italiana (con conseguente applicazione delle disposizioni della Convenzione di Vienna dell'11 aprile 1980 sui contratti di vendita internazionale di beni mobili, nella misura in cui non derogate dalle clausole del presente Contratto).

10.2 Foro competente in via esclusiva per tutte le controversie relative alla sottoscrizione, all'interpretazione, all'esecuzione ed allo scioglimento per qualsivoglia motivo delle presenti Condizioni e di tutti i contratti di vendita di cui siano parte il Venditore e l'Acquirente è quello della sede legale del Venditore, salva la facoltà per quest'ultimo di convenire l'Acquirente davanti ad ogni Foro avente giurisdizione nei confronti dell'Acquirente stesso.

GENERAL CONDITIONS OF SALE

GENERAL CONDITIONS OF SALE

Art. 1 - Scope of application of the General Conditions of Sale

1.1 - These general conditions of sale (hereinafter the "Conditions") shall apply to every contract of sale (hereinafter the "Contract") entered into by Tecomec (hereinafter the "Seller") which concerns the products manufactured and/or marketed by the Seller (hereinafter the "Products").

1.2 - Notwithstanding any provision to the contrary and even if any such provision may be contained in any possible general conditions of the buyer of the Products (hereinafter the "Buyer"), the Conditions shall apply to any offer, any order confirmation and any delivery effected by the Seller, except as expressly provided from time to time in a written document signed by the Seller.

Art. 2 - Conclusion and effective date of each Contract

2.1 - The Contract of sale of the Products shall be deemed to enter into force (i) at such time as the Seller issues the relevant order confirmation, or in absence of such an order confirmation, (ii) at such time as the Buyer collects the Products.

2.2 - The Buyer's orders will be accepted by the Seller only if said orders contain the specifications which are necessary for the purpose of identifying the Products ordered, it being understood that the Seller shall be entitled, at its sole discretion, to accept or refuse the Buyer's orders.

2.3 - Any possible cancellation of or amendment to any order by the Buyer shall not be effective unless previously authorised or subsequently accepted in writing by the Seller (it being in any event understood that the Seller's commercial agents, intermediaries and/or external consultants shall not have the power to accept the Buyer's orders on behalf of the Seller and/or to formulate or accept any proposal, in such a way as to bind the Seller, relating to discounts, sales allowances and/or variations to the Conditions.

Art. 3 - Terms of payment and Prices

3.1 - Unless otherwise agreed in writing, the Seller's price list which is in force as of the date of the order confirmation shall apply to any order made by the Buyer. The prices of any Products not appearing on the price list shall be determined by the Seller on a case by case basis.

3.2 - The prices of the Products shall be deemed exclusive of VAT and of any other incidental expense and/or cost (including, but not limited to, bank commissions or expenses, special packaging, insurance, transport), which shall be borne by the Buyer.

Without prejudice to the above, any and all taxes, duties, levies, licences, authorisations, permits and any and all tax and administrative or customs formalities or costs relating to the importation and/or re-sale of the Products shall be borne and carried out exclusively by the Buyer or, alternatively, they may be carried out by the Seller at the Buyer's sole risk, expense and responsibility.

3.3 - Unless otherwise indicated in the order confirmation, payment of the price of the Products will be effected within 30 (thirty) days following the date of issue of the relevant invoice.

Under no circumstances shall the Buyer be entitled to suspend or delay payment of the Products. In the event that the Buyer fails to fulfil its obligations to pay the price (including the obligation to make any possible advance payments), the Seller shall be entitled to postpone the delivery of the Products for a period corresponding to the length of the delay on the part of the Buyer and/or to terminate the Contract, retaining the sums received from the Buyer by way of liquidated damages, without prejudice to the Seller's rights to claim compensation for any further damages suffered.

Art. 4 - Terms of delivery and packaging

4.1 - All delivery dates as well as delivery terms given in the order confirmation shall be deemed to be indicative only. In the event of possible late delivery, the Buyer shall not be entitled to terminate the Contract or claim compensation for damages of whatever nature (it being in any event understood that by collecting any Products which may have been delivered late, the Buyer waives any and all rights relating to said delay).

4.2 - Unless otherwise agreed in writing between the parties, the delivery of the Products (and the relating transfer of risk) will be effected "EX WORKS" (Incoterms 2000); in the light of the above, the Seller shall not enter into any shipment or transportation agreement and shall not insure the Products to be supplied, unless the Buyer should so expressly instruct the Seller in writing; it being in any event understood that any and all risks and expenses in relation thereto shall be borne exclusively by the Buyer.

4.3 - The Buyer agrees to collect the Products as soon as it receives notice that the Products are ready and at its disposal and, in any event, within 8 (eight) days of the date of said notice. In any event, the transfer of risk and the payment terms shall start running as of the date of the notice that the Products are ready or, in the absence thereof, as of the date of delivery.

4.4 - At the time of delivery of the Products the Buyer shall check the quantity and the specifications of the Products delivered. Any claim by the Buyer in respect of the quantity or the quality of the delivered Products shall be communicated in writing to the Seller within no more than 8 (eight) days following the date of delivery of the Products.

4.5 - The Products shall be delivered by the Seller to the Buyer with appropriate packaging; it being understood that the packaging provided by the Seller is suitable for a period of storage/transit not exceeding 180 (one hundred and eighty) days. Provided that the Buyer advises the Seller sufficiently in advance that the goods may be in storage/transit for a period exceeding 180 (one hundred and eighty) days, then the Seller may supply the Buyer, at the latter's expense, with different packaging.

4.6 - From such time as the Products are delivered, the Buyer undertakes to look after the Products with the requisite care (keeping them in a safe and appropriate place and in such a way that they are not subjected to inappropriate climatic conditions and temperatures), given that the ownership of the Products shall pass to the Buyer only upon payment in full of the sale price of the Products. In the event that the Buyer fails to pay the price, the Seller shall be entitled, without any formalities, including sending a notice of default, to repossess all of the Products with respect to which title has not yet passed to the Buyer, wherever said Products may be; in addition, the Seller shall be entitled to charge interest on arrears at the rate provided by the applicable law (without prejudice to the Seller's right to seek any other judicial remedies available to it in respect of the damages suffered).

Art. 5 - Characteristics of the Products; Modifications to the Products

5.1 - Any possible information or data relating to the characteristics and/or to the technical specifications of the Products that may be included in brochures, price lists, catalogues, or similar documents are indicative only and not binding, unless otherwise agreed in writing by the parties.

5.2 - The Buyer shall be prohibited from making, directly or indirectly, any changes, modifications or other alterations whatsoever to the Products and should the Buyer breach such obligations, it shall bear any and all liability in respect of the Products, be it foreseeable or unforeseeable, arising out of the Contract, any unlawful act, in equity or otherwise.

5.3 Without prejudice to the above terms, the Seller reserves the right to update, modify or terminate the production of all or any of the Products as determined by the Seller at its sole discretion. In this regard, the Buyer acknowledges and agrees that changes in technology or in market conditions or in the Seller's sales and marketing policy may prompt the Seller to modify the Product specifications or to cease to manufacture or sell one or more types of the Products and that the Seller shall not be in any way liable to the Buyer for any possible damages, be they direct or indirect, which may be suffered by the Buyer as a result of such decision by the Seller.

Art. 6 - Liability

6.1 - Without prejudice to the limitations of the warranty as per Art. 7 below, the Seller's total liability may not in any event exceed an amount equal to 7% (seven percent) of the price agreed for the Products in respect of which the claim occurs.

6.2 - The Buyer undertakes to read and make itself acquainted with the specifications of the Products and the instructions and warnings supplied in relation to the use that may be made of said Products and the use for which the Products may be reasonably intended. In addition, the Buyer shall ensure that the Products will only be marketed as of such time as they comply with all laws, regulations and other rules (relating to packaging, instructions, information, and in general, to the safety of persons and goods) provided by the country in which the Products will be marketed. The Buyer shall be solely responsible for ensuring that the use and marketing of the Products are correct and in compliance with the above-mentioned regulations and laws, in addition to the requirements of the Buyer's customers and good technique and the Buyer shall indemnify and hold the Seller harmless with regard to the terms of this Art. 6.2.

Art. 7 - Warranty

7.1 - The Seller warrants the quality of the Products for a period of 12 (twelve) months following the date of delivery, subject to the customary tolerances and excluding those defects which may arise due to transportation, improper use or inappropriate storage or maintenance of the Products. Any other damages, including any possible damages resulting from the lack of or a reduction in production, in addition to any indirect, consequential, special or incidental or damages of a punitive nature, are expressly excluded from the warranty.

7.2 - The warranty shall be subject to the Buyer duly informing the Seller in writing, within 8 (eight) days following the discovery thereof, of the particular defect or lack of quality, failing which the Buyer shall lose its rights under the warranty in respect thereof, and shall also be subject to the Buyer making an express written request to the Seller to provide assistance under the warranty.

7.3 - The warranty consists in either the repair or replacement, at the Seller's sole discretion and at its expense, of the Products which may prove to be broken or defective due to manufacturing defects. The Seller shall replace or repair the defective parts in the shortest time possible (which shall be calculated on a case by case basis) and the Seller shall have the right to request the Buyer to return the defective parts and/or the Products which have been replaced.

7.4 - Any other warranty relating to the Products, including without limitation, any warranties provided by law, shall be deemed excluded and superseded by these Conditions.

Art. 8 - Returned Products

8.1 - The Products may be returned by the Buyer to the Seller only if the Seller has given its prior written authorisation in relation thereto. It is in any event understood that if the Buyer does not collect the Products within a period of 6 (six) months after they have been returned to the Seller (regardless of whether the return is unauthorised or in relation to Products which are no longer under warranty), the Seller shall be entitled to scrap said Products and to charge the Buyer the relevant costs, without prejudice to the Seller's right to be reimbursed by the Buyer for the costs relating to the storage of the returned Products.

Art. 9 - Force Majeure

9.1 - The Seller shall not be liable vis-à-vis the Buyer for any failure to perform, including late delivery or failure to deliver, which is caused by occurrences beyond the Seller's reasonable control or in any case caused by an event of force majeure, including, but not limited to, late delivery or non-delivery of manufacturing materials by suppliers, strikes and other trade union actions, suspension of electrical energy or difficulties in transportation.

9.2 - Upon the occurrence of any event of force majeure which is such as to prevent either party hereto from fulfilling its obligations hereunder, then the time for the party so affected to fulfil its obligations shall be automatically extended for a period corresponding to the duration of the event of force majeure, save for the Buyer's obligation to pay the amounts due by way of the price, in respect of which the contractually agreed due dates shall remain in full force and effect.

Art. 10 - Applicable Law and jurisdiction

10.1 - These Conditions and all contracts of sale to which the Seller and the Buyer are a party shall be exclusively governed by Italian law (including the provisions of the Vienna Convention 1980, relating to contracts for the international sale of goods, which are not derogated by these Conditions).

10.2 - Any and all disputes arising out of or relating to the signing, interpretation, execution and termination for any reason whatever of these Conditions and of the contracts of sale to which the Seller and the Buyer are a party, shall be settled exclusively by the courts of competent jurisdiction for the place in which the Seller's registered office is located. Notwithstanding the foregoing, the Seller may bring an action against the Buyer before any court having jurisdiction over the Buyer.

www.geoline.it

Il presente documento annulla e sostituisce tutti i precedenti.

Le informazioni contenute nel presente documento sono atte alla semplice individuazione del prodotto.

L'utilizzatore deve scegliere ed installare i prodotti in base alle leggi applicabili, alle norme e ai criteri essenziali di sicurezza in vigore.

I prodotti nel presente documento sono ad uso esclusivo di operatori professionali che abbiano le capacità necessarie per operare la scelta più opportuna del prodotto e per garantirne il suo utilizzo a regola d'arte.

Foto, dimensioni, caratteristiche e codifiche possono essere soggette a modifiche e variazioni senza preavviso. La documentazione, disponibile presso l'Ufficio Tecnico, garantisce tutti gli aggiornamenti.

Per informazioni più dettagliate riguardo alle caratteristiche e alle applicazioni dei prodotti richiamati a catalogo, si prega di contattare l'Ufficio Tecnico e/o la nostra Assistenza Tecnica.

This catalogue replaces any previous ones.

The information included in this catalogue simply intend to identify the product.

The user must choose and install the products according to the applicable laws and current safety regulation.

The products included in this catalogue are for the exclusive use of professional workers able to choose the right product, granting its better employment.

Pictures, dimensions, features and coding can be changed or modified without prior notice. The documentation available by our Technical Department offers the appropriate updating.

For more detailed information concerning features and use of the products included in this catalogue, please contact our Technical Department.

TeeJet®, FullJet®, ConeJet®, Turbo FloodJet™, TwinJet®, - sono marchi registrati dalla Spraying System company, Wheaton, IL, USA.

Teflon®, Viton®, Delrin®, - sono marchi registrati dalla E.I. DuPont de Nemours and Company, USA.

Albuz®, - è un marchio registrato dalla Norton Desmarquest, FRANCE.

Arag®, - è un marchio registrato della ARAG Srl - Italia.

LECHLER® - è un marchio registrato della **Lechler GmbH**
Agrardüsen - Agricultural Nozzles, Germania.

TRIMBLE® - è un marchio registrato di **Trimble Inc.**

TeeJet®, FullJet®, ConeJet®, Turbo FloodJet™, TwinJet®, - are registered trademark of Spraying System company, Wheaton, IL, USA.

Teflon®, Viton®, Delrin®, - are registered trademark of E.I. DuPont de Nemours and Company, USA.

Albuz®, - is a registered trademark of Norton Desmarquest, FRANCE.

Arag®, - is a registered trademark of ARAG Srl - Italy.

LECHLER® - is a registered trademark of **Lechler GmbH**
Agrardüsen - Agricultural Nozzles, Germany.

TRIMBLE® - is a registered trademark of **Trimble Inc.**



Sono marchi di proprietà Tecomec S.r.l.
Are Tecomec S.r.l. owned brands

FILIALE TECOMECC S.R.L.

Spraycom Comércio de Peças para Agricultura S/A
Av. Said Tuma, 600 – Distrito Indl. José Antonio Boso
15803-150 – Catanduva SP
Brasile

TECOMECC S.R.L. SUBSIDIARY

Spraycom Comércio de Peças para Agricultura S/A
Av. Said Tuma, 600 – Distrito Indl. José Antonio Boso
15803-150 – Catanduva SP
Brazil



Questo catalogo è stato stampato con inchiostri vegetali e matrici ecologiche prodotte senza bagni chimici.
This catalogue has been printed using vegetal inks and no process plates.

Questo catalogo è stampato su carta certificata FSC®.
This catalog is printed on FSC® certified paper.





TECOMEC S.r.l.
STRADA DELLA MIRANDOLA, 11
42124 REGGIO EMILIA - ITALY
TEL +39 0522 959001
FAX +39 0522 959060
SALES_DEPT@GEOLINE.IT
WWW.GEOLINE.IT - WWW.TECOMEC.COM



CERTIFIED QUALITY SYSTEM
UNI EN ISO 9001



www.geoline.it

